

## Ambi® Chairs

Prices effective December 7, 2009

<b>Introduction</b>	<b>page 2</b>
<b>Ambi® Chairs</b>	<b>3</b>
Work Chair	5
Accessories	7
<b>Appendices</b>	
To view and/or print price book appendices, select the appropriate price book from <a href="http://www.HermanMiller.com">www.HermanMiller.com</a> .	



# Introduction

## A Note on the Organization of This Book

There are a few signals that will help you understand the organization of this book. Once you know them, you should be able to find your way around easily.

### Like a newspaper, this book is formatted with columns of text and illustrations that run vertically.

Information wraps from one column to the next and continues for as many pages as it needs to.

### Black bars are clues.

A black bar at the top of a page signals the start of information about a product.

This information is divided into two sections, each signaled by a black bar. Product Information includes a description, additional notes, and dimensional drawings. Specification Information, which always begins at the top of a column, includes a series of steps. Each step represents a decision you need to make in order to complete your product number. Steps must be followed sequentially. The number of pages needed to complete information on a product varies; some will be complete in one page; others may fill three or four pages. Just continue going through the steps until you run into the next product, signaled by the black bar at the top of the page.

Black tabs running along the outside edge of the page help you locate what section you are in or what section you want to go to. You can thumb forwards or backwards to find a section; tabs and text appear on both sides of the page.

The additional pages in the back of the book include the appendices and indices. They are signaled by a long black bar running along the outside edge of the page.

### The index is presented two ways.

The first index is in alphabetical order by product name. It can be helpful if you are new to the products and numbering scheme or if you are looking for a type of product, such as work chair or round table.

The second index is by product number. It lists, in alphanumeric order, the base product number, typically a five-digit number.

## General Information

This book is effective December 7, 2009, subject to change without notice. Products may be purchased from authorized Herman Miller dealers who will quote prices upon request. For more information about our products and services or to see a list of dealers, visit [www.HermanMiller.com](http://www.HermanMiller.com).

All prices are list prices. Additional services, such as planning services, design, storage, and installation, are not included and must be added to these prices when the additional services are requested.

Illustrations, specifications, and prices are based on the latest information at the time of publication. The right is reserved to make changes at any time without notice in prices, fabrics, finishes, materials, specifications, and models, and also to discontinue models and finishes.

Dimensions shown in the drawings are engineering drawing dimensions rounded up to the nearest  $\frac{1}{8}$ ". Product is shipped set up or knocked down. Products that include "Shipped knocked down" in the description require some assembly. If this statement does not appear in the description, the product is shipped assembled.

Service problems are normally handled by a Herman Miller authorized dealer. Where this cannot be accomplished on a local level, service problems should be referred to the Customer Care Representative for your region, Herman Miller, Inc., Zeeland, Michigan 49464.

### 20-Day or Less/Assigned Lead-Time Shipments

All products and options in this price book not designated by an Assigned Program icon  will ship in **20 business days or less** after being acknowledged by Herman Miller.

Products and options designated by an  are on the assigned lead-time program and may ship in 20 days, less than 20 days, or more than 20 days from order acknowledgement.

**Work Chair**

**Accessories**



## Work Chair

AM111  
AM112  
AM113  
AM121  
AM122  
AM123



### Product Information

#### Description

This chair has seat and back cushions with foam padding and a 5-star base. It includes pneumatic seat-height adjustment and 4" back-height adjustment. The chair has a CoActive™ tilt mechanism that synchronizes the movement of the chair's seat and back. The tilt also provides an open thigh-to-trunk angle that helps to reduce pressure on the spine in the lumbar area and provides consistent balance to the user through a range of postures.

There are 3 tilt options: A standard tilt; a tilt lock that allows the user to lock the seat angle in a horizontal, mid-range, or fully reclined position; and a tilt lock and forward seat angle that allows the user to lock the seat angle in a 5° forward, horizontal, mid-range, or fully reclined position.

Arm choices include no arms, fixed arms, or adjustable arms that adjust 4" vertically and pivot outward and inward.

Seat-depth adjustment option adjusts the seat from 17" to 19".

Fire-retardant chair meets CAL 133 requirements; this chair is manufactured with cushions covered with a fire-barrier material and upholstered in approved fire-retardant fabrics.

#### Notes

To help determine appropriate seat height and seat depth, see Ambi® User Size/Fit Reference in Appendices. Chair is tested and warranted for use by persons 300 pounds and under.

For information on casters and glides, see Casters and Glides in Appendices.

Customer's Own Material (COM) requires 1½ yards; add 1 yard COM to chair with fabric-back outer shell. Customer's Own Leather (COL) requires 19 square feet; add 13 square feet COL to chair with leather-back outer shell (FB option). See Order Information in Appendices.

### Dimensions

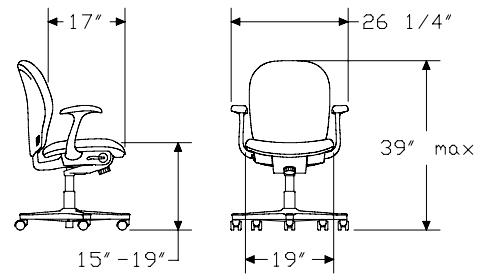

Low-Height Range

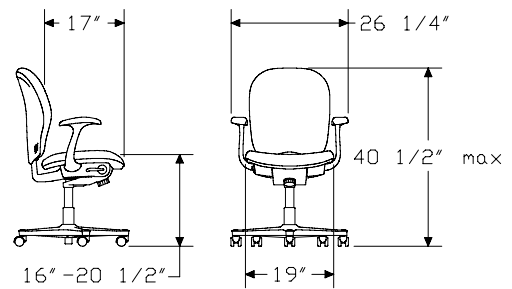

Standard-Height Range

**Specification Information**

Step 1.

**AM1**

Step 2. Height Adjustment

- 1** low-height range
- 2** standard-height range

Step 3. Tilt

- 1** standard tilt
- 2** tilt lock
- 3** tilt lock and forward seat angle

Step 4. Arms

- N** no arms
- P** fixed arms
- A** adjustable arms

Step 5. Fire Retardancy

*For not fire retardant (\*), skip this step.*

- FR** fire retardant

Prices for Steps 1-5.

		*	FR
<b>AM111</b>	<b>N</b>	\$700	766
	<b>P</b>	\$766	832
	<b>A</b>	\$898	964
<b>AM112</b>	<b>N</b>	\$731	796
	<b>P</b>	\$796	862
	<b>A</b>	\$928	994
<b>AM113</b>	<b>N</b>	\$760	826
	<b>P</b>	\$826	893
	<b>A</b>	\$958	1024
<b>AM121</b>	<b>N</b>	\$700	766
	<b>P</b>	\$766	832
	<b>A</b>	\$898	964
<b>AM122</b>	<b>N</b>	\$731	796
	<b>P</b>	\$796	862
	<b>A</b>	\$928	994
<b>AM123</b>	<b>N</b>	\$760	826
	<b>P</b>	\$826	893
	<b>A</b>	\$958	1024

Step 6. Seat-Depth Adjustment		
<b>AS</b>	adjustable	+\$0

Step 7. Base Finish/Frame and Outer Shell Finish		
<b>BU</b>	black umber	+\$0
<b>MT</b>	medium tone	+\$0

Step 8. Casters/Glides		
<b>BB</b>	2½" hard caster, black yoke, carpet	+\$0
<b>C7</b>	2½" caster, black yoke, hard floors or carpet	+\$40
<b>C9</b>	2½" braking caster, black yoke, hard floors or carpet	+\$40

Step 9. Outer Shell Finish		
<b>U6</b>	nonupholstered	+\$0
<b>FB</b>	fabric back	+\$160

Step 10. Armpad Finish		
<i>For fixed arms (P) or adjustable arms (A)</i>		
<b>BU</b>	black umber	+\$0
<b>MT</b>	medium tone	+\$0

Step 11. Fabric		
<i>See application chart and textiles list for fabric usage and numbers. First 2 digits of number indicate fabric line; remaining digit(s) indicate fabric color.</i>		
<i>ColorGuard Vinyl not available on FB outer shell.</i>		

<i>For not fire retardant</i>		
Price Category 1		+\$0
Price Category 2		+\$20
Price Category 3		+\$40
Price Category 4		+\$65
Price Category 7		+\$175
Price Category B		+\$40
Price Category E		+\$95
Price Category H		+\$230

<i>For fire retardant (FR)</i>		
Price Category 1		+\$0
Price Category 2		+\$20
Price Category 3		+\$40

# Adjustable Arm Kit

AM900

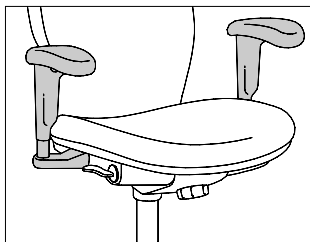

### Product Information

#### Description

These arms retrofit to an Ambi® work chair. They adjust 4" vertically and pivot outward and inward. Attachment hardware included.

Fire-retardant arms meet CAL 133 requirements.

#### Dimensions

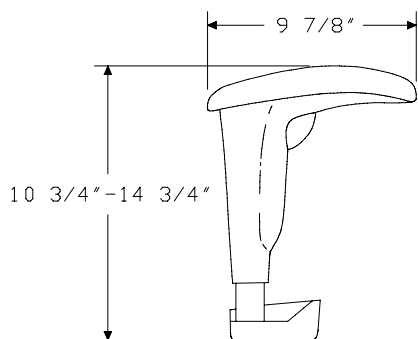

### Specification Information

#### Step 1.

##### AM900

#### Step 2. Armpad Upholstery

**X** no armpads

**AN** nonupholstered armpads

#### Step 3. Fire Retardancy

*For not fire retardant (\*) or no armpads (X), skip this step.*

**FR** fire retardant

#### Prices for Steps 1-3.

	*	FR
<b>AM900 X</b>	\$183	—
<b>AN</b>	\$208	221

#### Step 4. Frame Finish

**BU** black umber

+\$0

**MT** medium tone

+\$0

#### Step 5. Armpad Finish

*For nonupholstered armpads (AN)*

**BU** black umber

+\$0

**MT** medium tone

+\$0

For more information about our products and services or to see a list of dealers, please visit us at [www.HermanMiller.com](http://www.HermanMiller.com) or call (800) 851 1196.

This book is recyclable. Printed in U.S.A. on recycled paper.

© 2009 Herman Miller, Inc., Zeeland, Michigan

© HermanMiller, , Abak, Action Office, Aeron, Ambi, Ardea, Aside, Avive, Babble, C2, Caper, Celle, Co/Struc, DOT, Eames, Embody, Equa 2, Ergon 3, Ethospace, Fine-Tune, FlexFront, Formcoat, Ground Cloth, Herman Miller for Healthcare, Herman Miller Options, Intersect, Kinemat, Leaf, Lifework, Limerick, Meridian, Mirra, Passage, Pedastool, Pellicle, Perspectives, PostureFit, Prospects, Quadrant, Reaction, Resolve, RoomTune, Scooter, Stoa, Teneo, V-Wall, Vary Easy, Vivo, and Z-Axis are among the registered trademarks of Herman Miller, Inc., and its owned subsidiaries.

™ About Face, AireWeave, Airia, Arrio, Backfit, Boomerang, Bubbletack, Burdick Group, Celeste, Cellular Suspension, CLT, CoActive, Cognita, Compass, Cygnus, Enchord, EnhancedAccess, E-Wall, Flex-Edge, Flute, Harmonic, Herman Miller for the Home, Herman Miller International Collection, Herman Miller Select, Hopsak 2, Intent, Iota, Keyless Entry, Latitude, Lyris, Multiscrim, My Studio Environments, Nelson, Pixelated Support, Programmable Environments, Q, Rapunzel, Recline Selector, Sense, Setu, Stackable, Stackable Storage, The Be Collection, Thinking is good for you, TriFlex, Tu, and Twist are among the trademarks of Herman Miller, Inc., and its owned subsidiaries.

SM TAP, Textile Alliance Program and Thoughtpile are among the service marks of Herman Miller, Inc.

Chemsurf is a registered trademark of Wilsonart International.

Corian is a registered trademark of DuPont.

FLEXNET is a trademark of Milliken & Co.

Floor Saver Glide™ is a trademark of Carpin Manufacturing Inc.

Geiger is a registered trademark of Geiger International.

Goetz is a trademark of Mark W. Goetz.

Hang-It-All is a registered trademark of Lucia Eames Demetrios, d.b.a. Eames Office.

Holophane is a registered trademark of Holophane.

Ingeo is a trademark of Cargill Dow LLC.

Microsoft and Natural Keyboard are registered trademarks of Microsoft Corporation.

Noguchi® is a registered trademark of The Isamu Noguchi Foundation and Garden Museum.

Qt Quiet technology and Qt are trademarks of Cambridge Sound Management, Inc.