



GSA prices effective January 30, 2023
(based on October 3, 2022, commercial price list)
Published April 2024

Multipurpose Seating

Fuld Nesting Chairs

General Services Administration Federal Supply Service Authorized Federal Supply Schedule Price List

Online access to contract ordering information, terms and conditions, up-to-date pricing, and the option to create an electronic delivery order is available through GSA Advantage!®, a menu-driven database system.

The Internet address for GSA Advantage! is www.gsaadvantage.gov.

Office Furniture
FSC/PSC 7110/7125
Contract Number: GS-03F-036DA
UEI: Q2K3MSZ843D8
Contract Period: December 21, 2015—December 20, 2025

MillerKnoll, Inc.
855 East Main Avenue
Zeeland, Michigan 49464
(616) 654 3000 Phone
(616) 654 8278 Fax
www.HermanMiller.com/government

Business Size: Large

Contract Information

1a. Special Item Numbers (SIN)

SIN 33721

Furniture Systems, Computer Furniture, Filing and Storage, Tables and Accessories, Upholstered Seating and Multi-Purpose Seating, Project Management, Reconfiguration and Relocation Services, Design/Layout and Installation Services

SIN 33721P

Packaged Offices

SIN 337127

Modular Laboratory Furniture Systems

SIN 339113H

Healthcare Furniture

SIN OLM

Order-Level Materials (OLMs)

This SIN is only for products and/or services used in direct support of the purchase of new furniture. It requires approval from the ordering Contract Officer. Please contact your local MillerKnoll Inc. representative to discuss the appropriate use of this SIN.

SIN 532289

Leasing

Contact MillerKnoll Inc participating government dealer for current leasing information.

1b. Lowest Priced Model

SIN 33721:	BVP3.S	\$7.27
SIN 33127:	TW113	\$5.81
SIN 339113H:	CR900NR	\$483.80

1c. Service Rates

Project Management

Furniture Project Manager: \$64.75 per hour
 Furniture Project Coordinator: \$49.00 per hour
 Build-Out Project Manager: \$80.00 per hour

Reconfiguration and Relocation Services

Not to exceed \$55 per hour.

See * Additional Notes for Installation & Reconfiguration and Relocation Services.

Design/Layout

Not to exceed \$65 per hour.

Installation Services

Not to exceed \$55 per hour (\$82.50 per hour for after-hours Installation).

See * Additional Notes for Installation & Reconfiguration and Relocation Services.

2. Maximum Order

SIN 33721, 337127, NEW, OLM

\$250,000 net product value

SIN 33721P

\$250,000 net value

SIN 339113H

\$500,000 net product value

3. Minimum Order

\$100 net

4. Geographic Coverage

Continental U.S.

Orders for Alaska, Hawaii, and Puerto Rico will be shipped F.O.B. inland carrier point of exportation.

5. Point of Production

Zeeland, Ottawa County, Michigan

Spring Lake, Ottawa County, Michigan

6. Pricing

Prices shown are list. Discounts include Industrial Funding Fee.

SIN 33721

Standard Lead Time, Single Order Net Purchase \$100 - 250,000, includes approved Herman Miller Options Products.

Product Line	Discount From List
Action Office 1	73.8%
Action Office 2	73.8%
Aeron	64.5%
Ambit Workspace Solutions	74.3%
Aside	64.2%
C-Style Overhead Storage	73.8%
Canvas Office Landscape Channel	74.8%
Canvas Office Landscape Dock	74.8%
Canvas Metal Desk	74.8%
Canvas Office Landscape Metal Storage	74.8%
Canvas Office Landscape Private Office	74.8%
Canvas Office Landscape Wood Storage	74.8%
Canvas Office Landscape Vista	74.8%
Canvas Office Landscape Wall	74.8%
Caper	61.5%
Commend Nurses Station	73.3%
Cosm	61.7%
Eames® Aluminum Group	58.7%
Eames Conference & Dining Tables	73.6%
Easton Family	54.91%
Embody	59.7%
Energy Distribution Systems	73.8%
Ethospace System	73.8%
Everywhere™ Tables	73.8%
Exclave	61.7%
Fuld	59.7%
Headway™ Tables	73.8%
Intent Solution	58.7%

Contract Information

continued

Layout Studio®	60.7%
Lighting	73.8%
Lino	63.7%
Meridian Laterals	67.3%
Meridian Pedestals	64.2%
Meridian Towers	62.7%
Meridian Storage	62.7%
Mirra 2	61.7%
Motia Tables	73.8%
Nemschoff	54.91%
Nevi™ Tables	73.8%
Nevi Link	73.8%
OE1 Boundary	72.8%
OE1 Community Elements	61.7%
OE1 Micro Packs	73.8%
OE1 Storage	72.8%
OE1 Tables and Benching	73.8%
Overlay™	62.7%
Plex® Lounge Furniture	59.5%
Public Office Landscape	61.7%
Renew™ Tables	73.8%
Renew Link	73.8%
Sayl	62.2%
Setu	59.7%
Swoop Lounge Furniture	60.7%
Thrive Portfolio	62.0%
Thrive Portfolio-CBS Products Extension	62.0%
Tu Lateral Files	74.3%
Tu Pedestals	73.8%
Tu Storage	74.3%
Tu Towers	74.3%
Tu Wood Cases	74.3%
Tu Wood Cubbies	74.3%
Tu Wood Credenzas	74.3%
Tu Wood Pedestals	74.3%
Tu Wood Towers	74.3%
Valor™ Family	54.91%
Verus	63.7%
Zeph	60.2%

Services

Please refer to section 19 for Terms and Conditions of Installation/ Reconfiguration and Relocation Services.

Project Management

Services under this SIN may be used only in conjunction with the purchase of new furniture. Please contact your local MillerKnoll Inc. representative to discuss the available labor categories (listed below). The hourly rates listed are “Not To Exceed” or “NTE” values.

Furniture Project Manager: \$64.75 per hour
 Furniture Project Coordinator: \$49.00 per hour
 Build-Out Project Manager: \$80.00 per hour

Reconfiguration and Relocation Services

Reconfiguration and Relocation Services will be provided by MillerKnoll Inc. or its participating dealer based on a fee not to exceed \$55 per hour.

See * Additional Notes for Installation & Reconfiguration and Relocation Services.

Design/Layout

Design service will be provided by MillerKnoll Inc. or its participating dealer based on a fee not to exceed \$65 per hour.

Installation Services

Installation Services will be provided by MillerKnoll Inc. or its participating dealer based on a fee not to exceed \$55 per hour (\$82.50 per hour for after-hours Installation).

See * Additional Notes for Installation & Reconfiguration and Relocation Services.

SIN 337127

Standard Lead Time, Single Order Net Purchase \$100 - 250,000, includes approved Herman Miller Options Products.

Product Line	Discount From List
Action Lab	58.5%
Compass System	58.5%
Co/Struc System	58.5%
Healthcare Carts	18.0%
Mora System	58.5%
Bedside Cabinets	58.5%

SIN 33721P

Packaged Office Furniture - Maximum Order \$250,000 (net).

Includes packaged furniture solutions for customers needing to furnish an office.

SIN 339113H

Standard Lead Time, Single Order Net Purchase \$100 - 500,000, includes approved Herman Miller Options Products.

Product Line	Discount From List
Nemschoff Healthcare Furniture	54.91%

7. Quantity Discounts

Reference item #6.

8. Payment Terms

Net 30 days

9. Foreign Items

None

10. Time of Delivery

- a. 90 day ARO
- b. Expedited delivery: Items listed in the 10-Day section of the catalogs are available for expedited delivery.
- c. Overnight/2-day delivery: Select items may be available for overnight or 2-day delivery. Contact MillerKnoll Inc. or a participating dealer for availability and rates.
- d. Urgent requirements: Agencies may contact contractor or participating dealer to request faster delivery.

11. F.O.B.

F.O.B. destination except Alaska, Hawaii, and Puerto Rico, which will be shipped F.O.B. inland carrier point of exportation.

Contract Information

continued

12. Ordering Address

- a. MillerKnoll Inc.
Government Customer Care 0161
855 East Main Avenue
Zeeland MI 49464.
- b. For supplies and services, the ordering procedures information on Blanket Purchase Agreements (BPA's) are found in Federal Acquisition Regulation (FAR) 8.405-3.

13. Payment Address.

MillerKnoll Inc.
22764 Network Place
Chicago, IL 60673-1227

14. Warranty

MillerKnoll Inc. commercial warranty applies.

15. Export Packing Charge

Prices supplied on request.

16. Rental Maintenance and Repair Terms

Not applicable

17. Terms and Conditions of Installation/Reconfiguration and Relocation Services

* Additional Notes for Installation & Reconfiguration and Relocation Services:

FOB Destination (Drop Ship): Price includes product delivery to the site, brought to the tailgate of the truck. The purchaser is responsible for unloading.

Prices effective up to the maximum order by SIN only. Above the MO, pricing shall be negotiated on a case-by-case basis between the client and local dealer.

Standard Services are Subject to the Following Conditions:

Installation will be performed during normal weekday working hours.

Adequate facilities for delivery, unloading, moving and staging/storing the product during the installation process shall be provided.

Service work will not be hindered by other trades.

Electric, heat, and adequate elevator service will be furnished without charge.

The immediate installation area shall be complete and free of debris including the carpet/flooring before installation commences.

Any work requiring a licensed electrician is the responsibility of the buyer.

Additional Charges May Apply For:

Major Metro Markets and any non-ground floor installation.

Major Metro Markets include large population centers and urban environments.

Installation in a clinical/medical environment.

Special restrictions or limits established by local laws, ordinances or the directions of the buyer, including but not limited to restrictions on transportations of materials, street access to the job site and/or dock facilities.
Installations outside of a 50 mile radius of the servicing dealer.
Local Prevailing Wage and/or Union Labor Rates.
Any additional charges shall be quoted by the dealer and approved by the buyer prior to performance of the work.

18. Terms and Conditions of Repair Parts

Not applicable

19. Service and Distribution Points

For service and distribution points nearest you, call (800) 851 1196.

20. Participating Dealers

Access Herman Miller web site for current list of participating dealers: www.HermanMiller.com/where-to-buy/contact-a-dealer/. Select your market by using the filter.

21. Preventive Maintenance

Not applicable

22a. Special Attributes.

2022

MillerKnoll earns its 15th consecutive perfect score in Human Rights Campaign Foundation's 2022 Corporate Equality Index.

2021

The OE1 Trolley and Micro Packs are both winners of the 2021 Archiproducts international design competition in the Office Category.

MillerKnoll is named to Michigan's Best and Brightest in Wellness List for 2021.

MillerKnoll is awarded Platinum Rating in CSR by EcoVadis.

OE1 is named winner of Wallpaper's "Most Futuristic Furniture" Category as part of their first-ever Smart Space Awards.

OE1 receives the Workplace category award from Fast Company's 2021 Innovation by Design Awards.

MillerKnoll is named to Fast Company's Annual List of the World's Most Innovative Companies for 2021.

MillerKnoll is recognized as a "Disclosure Leader" by the Chemical Footprint Project (CFP).

MillerKnoll earns its 14th consecutive perfect score in Human Rights Campaign Foundation's 2021 Corporate Equality Index.

Contract Information

continued

MillerKnoll is named to Newsweek's List of America's Most Responsible Companies 2021.

Great Lakes Women's Business Council awards MillerKnoll for "Excellence in Supplier Diversity" in the Best In Class category.

2020

Herman Miller is recognized with a 2020 FSC® Leadership Award for our commitment to responsible forestry management.

Herman Miller is named one of Investor's Business Daily Top 50 Best ESG (Environmental, Social, and Corporate Governance) Companies.

Working Mother names Herman Miller as one of the Best Companies for Dads.

Herman Miller is awarded Platinum Rating in CSR by EcoVadis.

Herman Miller is named Diversity Inc 2020 Noteworthy Company for recruitment efforts, employee development opportunities, leadership accountability, and supplier diversity.

Cosm, by Studio 7.5, receives an iF Gold Award in the Office and Industry category at the iF World Design Awards 2020.

Herman Miller earns its 13th consecutive perfect score in Human Rights Campaign Foundation's 2020 Corporate Equality Index.

2019

Mora System casework, designed by Collective Ten for Herman Miller, receives silver in the Industrial and Life Science Design/Medical Furniture category at the European Product Design Awards.

Mora System casework is awarded GOOD DESIGN Award 2019, selected for design excellence and innovation.

National Minority Supplier Diversity Council (NMSDC) names Herman Miller as the 2019 Class 1 Corporation of the Year for leadership in supplier diversity.

TIME Magazine names Cosm to its list of 100 Best Inventions of 2019.

Herman Miller is named #12 Overall and #2 in Manufacturing on Investor's Business Daily Best ESG (Environmental, Social, Governance) Companies.

Herman Miller is recognized as a silver level Certified Veteran-Friendly Employer by the Michigan Veterans Affairs Agency for a commitment to veteran hiring, retention, and development.

For the second year in a row, Herman Miller receives a Gold Medal from EcoVadis in recognition of Corporate Social Responsibility achievement measured in categories of environment, labor and human rights, ethics, and sustainable procurement.

Herman Miller is named "Frontrunner" in Chemical Footprint Project by Clean Production Action for our chemical management policies and practices.

Herman Miller receives International Interior Design Association and Contract's best showroom design award in the "Large Showroom" category at NeoCon.

Herman Miller earns its 12th consecutive perfect score in Human Rights Campaign Foundation's 2019 Corporate Equality Index.

Cosm, designed by Studio 7.5 for Herman Miller, receives a Red Dot Best of the Best Product Design Award in the "Office Chairs" category.

Lino, designed by Sam Hecht and Kim Colin for Herman Miller, receives an iF Design Award in the Product Design category.

2018

Overlay, designed by Birsell+Seck, receives Interior Design Best of Year Award in the Partitions and Wall Systems category.

Herman Miller receives the "Corporation of the Year" in consumer products award from the Michigan Minority Supplier Development Council.

Herman Miller achieves the Advanced Excellence in Supplier Diversity Award from the Great Lakes Women's Business Council for doing business with women-owned suppliers.

Great Lakes Women's Business Council awards Herman Miller for "Excellence in Supplier Diversity" in the Advanced category.

WEConnect awards Herman Miller an Honorable Mention for global supplier diversity initiatives.

As one of the top-scoring companies in the industry for the 14th consecutive year, Herman Miller has qualified for inclusion in RobecoSAM's 2018 Sustainability Yearbook and receives the Silver Class distinction for excellent sustainability performance—economic, environmental, and social.

For the 11th consecutive year, Herman Miller receives a perfect score on the Human Rights Campaign Foundation's Corporate Equality Index and is designated as Best Place to Work for LGBT equality. This report evaluates U.S. companies in terms of diversity, particularly LGBT-related policies and practices.

Contract Information

continued

Herman Miller receives Gold Medal from EcoVadis in recognition of Corporate Social Sustainability achievement measured in categories of environment, labor and human rights, ethics, and sustainable procurement. EcoVadis operates the first web-based collaborative platform that allows companies to assess the environmental and social performance of their global suppliers.

Aeron receives Good Design Award from The Chicago Athenaeum Museum of Architecture and Design.

The Cosm Chair wins Mix Interiors “Product of the Year—Task” award.

2017

Herman Miller receives “Rising Star Award” from the Michigan Veterans Affairs Agency (MVAA) for exhibiting new and novel approaches to veteran recruitment and hiring.

Herman Miller is named the 2017 “Corporation of the Year” in the consumer products sector by the Michigan Minority Supplier Development Council (MMSDC).

Herman Miller receives a 2017 SEAL (Sustainability, Environmental Achievement and Leadership) Business Sustainability Award. SEAL Award winners are determined by a holistic methodology measuring applicants against established benchmarks that demonstrate impact and progress toward creating a healthy planet and a sustainable future.

Herman Miller earns the 4 Star Diversity Visionary Award. This award celebrates the diversity, equality, and inclusion work of Herman Miller. The award is presented at the annual Diversity Equity Inclusion Summit, held by the Grand Rapids Area Chamber of Commerce.

Herman Miller is named one of the Best and Brightest in Wellness for the 5th year in a row.

Herman Miller earns its 10th consecutive perfect score in Human Rights Campaign Foundation’s 2017 Corporate Equality Index.

As one of the top-scoring companies in the industry for the 13th consecutive year, Herman Miller has qualified for inclusion in RobecoSAM’s 2017 Sustainability Yearbook and receives the Bronze Class distinction for excellent economic, environmental, and social sustainability performance. The selection criteria for inclusion in the Yearbook becomes more rigorous each year, and only the top 15 percent of companies within each industry are selected.

Herman Miller once again earns the WorldatWork Seal of Distinction, a unique standard of excellence in work-life effectiveness that shows we provide a distinct, mutually beneficial workplace experience. Herman Miller is the only furniture manufacturer among the 160 companies across the U.S. and Canada honored with the award.

Herman Miller’s Mora wins Nightingale Silver Award in the “Furniture Collections” category at the 2017 Healthcare Design Conference.

2016

Herman Miller earns 9th consecutive perfect score in Human Rights Campaign Foundation’s Corporate Equality Index and is designated as Best Place to Work for LGBT equality.

Herman Miller is recognized as the Business of the Year at the Annual Meeting of the West Michigan Environmental Action Council (WMEAC) for being an outstanding partner in support of the growth of WMEAC’s programs. WMEAC’s award goes to the business with the greatest depth and breadth of support, unwavering dedication to environmental action in West Michigan, and a strong corporate commitment to environmental advocacy.

The 101 Best and Brightest Sustainable Companies once again (5th consecutive year) recognizes Herman Miller as an organization in Michigan (and for the first time, in the nation) that exhibits leadership and innovation in its approach to sustainability. This award celebrates those companies that are making their businesses more sustainable, the lives of their employees better, and the community, both locally and globally, more responsible as a whole.

Herman Miller is recognized by the Michigan Minority Supplier Development Council (MMSDC) as a “Corporation of the Year”. Additionally, we are the only West Michigan company this year to receive an “Ambassadors Championing Excellence” Award from the MMSDC.

Herman Miller is recognized with “2016 Excellence in Supplier Diversity Award” from the Great Lakes Women’s Business Council.

Herman Miller is recognized as a 2016 Healthiest 100 Workplace in America, ranking 49th in the country for our commitment to health and exceptional corporate wellness programming.

Herman Miller receives the Best and Brightest in Wellness Award for the 4th year in a row. This program is an innovative initiative that recognizes and celebrates quality and excellence in health awareness.

The Michigan Occupational Safety and Health Administration renews Herman Miller’s “Star” status, the highest workplace safety and health designation, for the Hickory facility in Spring Lake.

Plex Lounge Furniture from Herman Miller receives #MetropolisLikes award at NeoCon 2016.

Plex Lounge Furniture from Herman Miller receives Interior Design HIP Award for Workplace Seating/Lounge at NeoCon 2016.

Herman Miller is named a 2016 Women on Boards Winning Company. Companies selected for this recognition are considered champions of board diversity as 20 percent or more of their board seats are occupied by women.

Herman Miller is selected for inclusion in the 2016 RobecoSAM Sustainability Yearbook for the 12th consecutive year.

Contract Information

continued

Herman Miller again earns the WorldatWork Work-Life 2016 Seal of Distinction. This award identifies organizations that focus on programs that promote work-life balance and overall well-being.

22b. Section 508 Compliance

Not applicable

23. Unique Entity ID: Q2K3MSZ843D8

24. Registered in System for Award Management (www.SAM.gov) Database

25. Cancellation

Prior to production, no cancellation charge will apply. After production, only actual cost incurred that the contractor can demonstrate if items are sold after 3 months.

26. Restocking Charges

Agencies must notify the contractor for authorization prior to returning any items. The customer agency will be required to pay all packaging and return freight charges. A restocking fee of 50% for Systems Furniture and 35% for all other product lines will be charged for any returned items.

Returns and restocking policy is not applicable to Options products, products under SIN 337127, 339113H and Nemschoff products.

MillerKnoll Inc. Miscellaneous Information:

Federal ID Number: 38-0837640

Commercial and Government Entity Code (CAGE): 40636

Data Universal Numbering System (DUNS) 00-601-2801

Commercial Entity Code (CEC): 00702290J

Introduction	page 2
Fuld Nesting Chairs	3
Nesting Chair	5
Appendices	
20-Day or Less/Assigned Lead-Time Order Information	
Casters and Glides	
Textiles Application Chart-Seating	
Textile Colors	
For the latest materials information, refer to the Materials pages on HermanMiller.com.	

Introduction

A Note on the Organization of This Book

There are a few signals that will help you understand the organization of this book. Once you know them, you should be able to find your way around easily.

Like a newspaper, this book is formatted with columns of text and illustrations that run vertically.

Information wraps from one column to the next and continues for as many pages as it needs to.

Black bars are clues.

A black bar at the top of a page signals the start of information about a product.

This information is divided into two sections, each signaled by a black bar. Product Information includes a description, additional notes, and dimensional drawings. Specification Information, which always begins at the top of a column, includes a series of steps. Each step represents a decision you need to make in order to complete your product number. Steps must be followed sequentially. The number of pages needed to complete information on a product varies; some will be complete in one page; others may fill three or four pages. Just continue going through the steps until you run into the next product, signaled by the black bar at the top of the page.

Black tabs running along the outside edge of the page help you locate what section you are in or what section you want to go to. You can thumb forwards or backwards to find a section; tabs and text appear on both sides of the page.

The additional pages in the back of the book include the appendices and indices. They are signaled by a long black bar running along the outside edge of the page.

The index is presented two ways.

The first index is in alphabetical order by product name. It can be helpful if you are new to the products and numbering scheme or if you are looking for a type of product, such as work chair or round table.

The second index is by product number. It lists, in alphanumeric order, the base product number, typically a five-digit number.

General Information

This book is effective October 2, 2023, subject to change without notice. Products may be purchased from authorized Herman Miller dealers who will quote prices upon request. For more information about our products and services or to see a list of dealers, visit www.HermanMiller.com.

All prices are list prices. Additional services, such as planning services, design, storage, and installation, are not included and must be added to these prices when the additional services are requested.

Illustrations, specifications, and prices are based on the latest information at the time of publication. The right is reserved to make changes at any time without notice in prices, fabrics, finishes, materials, specifications, and models, and also to discontinue models and finishes.

Dimensions shown in the drawings are engineering drawing dimensions rounded up to the nearest $\frac{1}{8}$ ". Product is shipped set up or knocked down. Products that include "Shipped knocked down" in the description require some assembly. If this statement does not appear in the description, the product is shipped assembled.

Service problems are normally handled by a Herman Miller authorized dealer. Where this cannot be accomplished on a local level, service problems should be referred to the Customer Care Representative for your region, Herman Miller, Inc., Zeeland, Michigan 49464.

20-Day or Less/Assigned Lead-Time Shipments

All products and options in this price book not designated by an Assigned Program icon  will ship in **20 business days or less** after being acknowledged by Herman Miller.

Products and options designated by an  are on the assigned lead-time program and may ship in 20 days, less than 20 days, or more than 20 days from order acknowledgement.



Fuld Nesting Chair

NEC1P
NEC2P

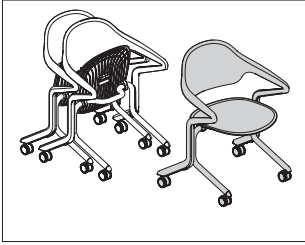

Product Information

Description

This nesting chair has a 1-piece frame including the arms made of 30% glass-filled nylon with tubular steel wall-saver legs to prevent the chair back from damaging walls. Seat flips up for easy nesting. To nest chairs together, flip seat up and nest front legs of chair between rear legs of another chair. Contoured backrest flexes to provide added comfort and movement. Seat/back options include a polymer seat and a 3D knit seat with polymer back. 3D knit seat is made with 50% post-consumer recycled polyester. The back/frame finish and seat finish can be specified as monochromatic or different colors. Chair is available with casters or glides. Ships fully assembled.

Notes

Optional 3D knit seat is permanently affixed to chair.
 3D knit seat does not accept Customer's Own Material (COM)/
 Customer's Own Leather (COL).
 It is recommended to nest a maximum of 6 chairs together when
 transporting.
 For information on casters and glides, see Casters and Glides in
 appendices.

Dimensions

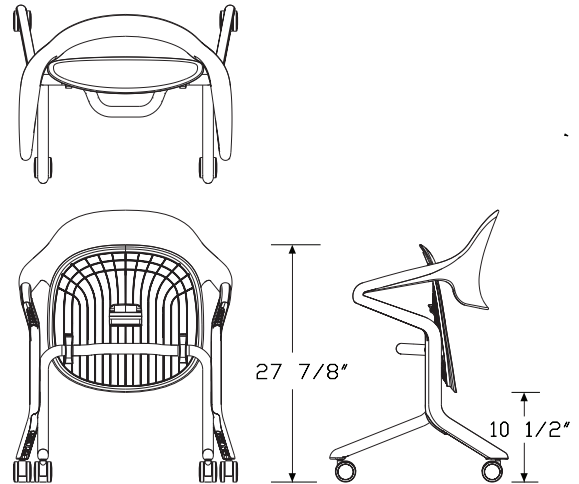
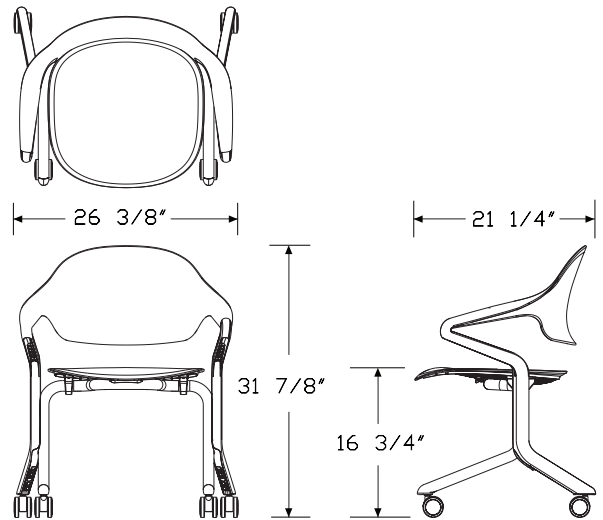

Fuld Nesting Chair *continued*



Specification Information		
Step 1.		
NEC		
Step 2. Seat/Back Material		
1	polymer seat and back	+\$596
2	3D knit seat, polymer back	+\$690
Step 3. Arm Options		
P	arms	+\$0
Step 4. Back/Frame Finish		
BK	black	+\$0
CC1	cocoa	+\$0
CRB	carbon	+\$0
DN2	nightfall	+\$0
DR1	canyon	+\$0
OLF	olive	+\$0
ZM	alpine	+\$0
Step 5. Seat Finish		
BK	black	+\$0
CC1	cocoa	+\$0
CRB	carbon	+\$0
DN2	nightfall	+\$0
DR1	canyon	+\$0
OLF	olive	+\$0
ZM	alpine	+\$0
Step 6. 3D Knit Seat		
<i>For 3D knit seat, polymer back (2)</i>		
Price Category 1		+\$0
Step 7. Casters and Glides		
BB	2½" hard caster, black yoke, carpet only	+\$0
GLN	acetal glide, carpet only <input type="checkbox"/>	+\$0
C7	2½" caster, black yoke, hard floors or carpet	+\$50
OC	2½" caster, medium roll resistance with quiet roll technology, black yoke, hard floors or carpet	+\$50
SC8	2½" caster, black yoke, hard floors or carpet with quiet roll technology	+\$50

20-Day or Less/Assigned Lead-Time Order Information

GSA

20-Day or Less and Assigned Lead-Time Programs

20-day or less and assigned lead-time products are designed for established Herman Miller dealers with pre-approved credit.

Products are distributed from multiple manufacturing facilities across the United States. All products and options not designated by an Assigned Lead-Time icon  will ship in 20 business days or less after being acknowledged by Herman Miller. Products and options designated by an  are on the assigned lead-time program and will ship in 20 days, less than 20 days, or more than 20 days from order acknowledgement.

Ordering Procedure

Please place orders through Order Manager. If this is not available to you, place orders through mail or fax. Verbal purchase orders will not be accepted.

Order Entry fax number for Meridian® Filing and Storage:

(616) 846 9236.

Order Entry fax number for all other products:

(616) 654 3085.

For more information, contact your Customer Care representative at:

(866) 854 3048 ext 3400.

Shipments and Delivery

Per Herman Miller Terms and Conditions.

Changes and Cancellation

Per Herman Miller Terms and Conditions.



Casters and Glides

GSA

⚠	WARNING	⚠
Depending on the floor surface, chair may unexpectedly roll away from user when entering or exiting the chair, possibly leading to unexpected injury. Please refer to descriptions of floor types when selecting casters.		

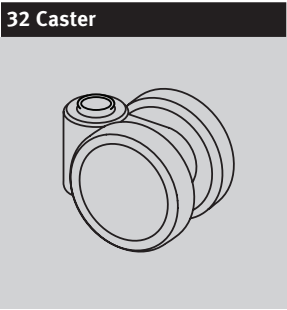

1 7/8-inch-diameter hard double-wheel caster; black nylon wheels and yoke; for use on carpet only
 Applicable on:
 Sayl® Chairs

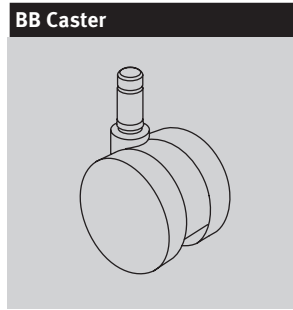

2 1/2-inch-diameter hard double-wheel caster; black nylon wheels and yoke; for use on carpet only
 Applicable on:
 New Aeron® Chairs
 Caper® Chairs
 Embody® Chairs
 Fuld Nesting Chairs
 Lino™ Chairs
 Mirra® 2 Chairs
 Sayl Chairs
 Verus™ Chairs

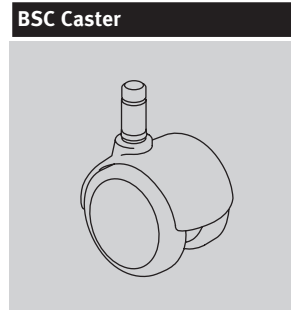

2-inch-diameter double-wheel caster; black nylon wheels and hood; soft polyurethane tread; for use on hard floors or carpet
 Applicable on:
 Eames® Aluminum Group

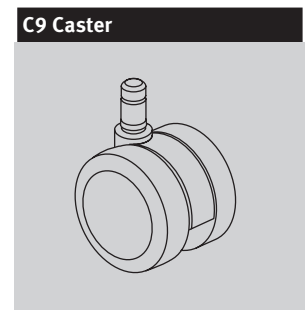

2 1/2-inch-diameter double-wheel caster; black nylon wheels and yoke; soft polyurethane tread; internal brake; for use on hard floors or carpet
 Applicable on:
 Caper Chairs
 Embody Chairs
 Lino Chairs
 Mirra 2 Chairs
 Sayl Chairs
 Setu Chairs Verus Chairs

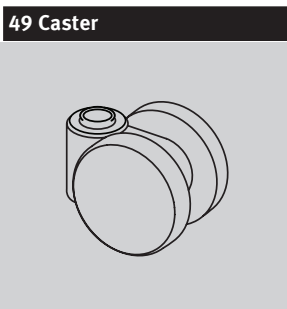

1 7/8-inch-diameter soft double-wheel caster; black nylon wheels and yoke; for use on hard floors or carpet
 Applicable on:
 Sayl Chairs



2 1/2-inch-diameter hard double-wheel caster; black yoke; quiet roll technology; for use on carpet only
 Applicable on:
 Cosm™ Chairs

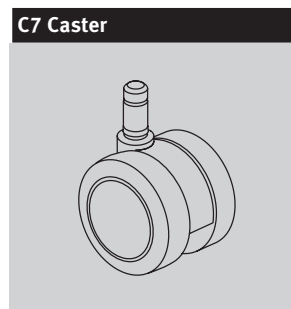

2 1/2-inch-diameter double-wheel caster; black nylon wheels and yoke; soft polyurethane tread; for use on hard floors or carpet
 Applicable on:
 New Aeron Chairs
 Caper Chairs
 Embody Chairs
 Fuld Nesting Chairs
 Lino Chairs
 Mirra 2 Chairs
 Sayl Chairs Verus Chairs

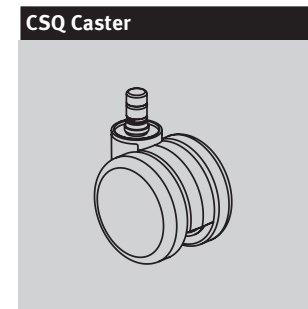

2 1/2-inch-diameter double-wheel caster; color-matched nylon wheels and yoke; soft polyurethane tread; for use on hard floors or carpet
 Applicable on:
 Zeph® Chairs

Casters and Glides

continued

GSA

DC1 Caster

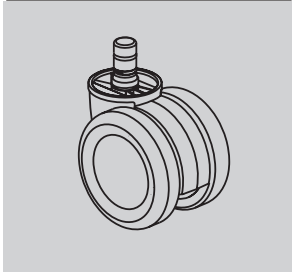

2¹/₂-inch-diameter double-wheel braking caster; black nylon wheels and yoke; for use on hard floors or carpet; quiet roll technology

Applicable on:
New Aeron Chairs

H9 Caster

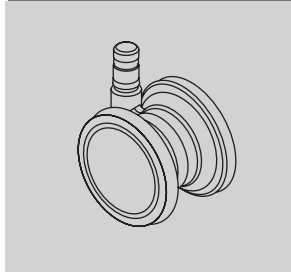

2¹/₂-inch-diameter double-wheel caster; clear polycarbonate wheels; nylon yoke; soft polyurethane tread; for use on carpet only.

Applicable on:
Embody Chairs

MD Caster

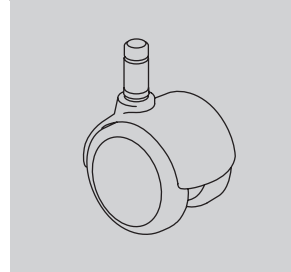

2-inch-diameter double-wheel caster; black nylon wheels with integral chrome hood; soft polyurethane tread; for use on hard floors or carpet

Applicable on:
Eames® Aluminum Group

SC8 Caster

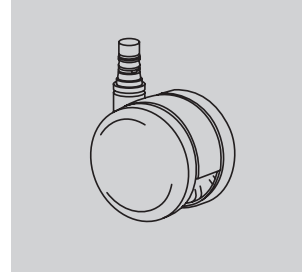

2¹/₂-inch-diameter double-wheel caster; black nylon wheels and yoke; soft polyurethane tread; quiet roll technology; for use on hard floors or carpet

Applicable on:
Cosm Chairs
Fuld Nesting Chairs
Lino Chairs
Mirra 2 Chairs
Verus Chairs

DS Caster

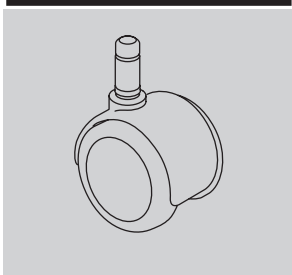

2-inch-diameter soft double-wheel braking caster; black nylon wheels and hood; for use on hard floors only

Applicable on:
Aside® Chairs
Caper Chairs

HCC Caster

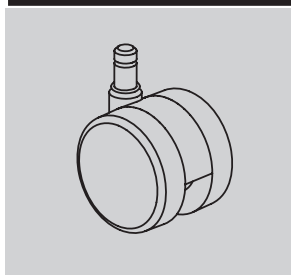

2¹/₂-inch-diameter double-wheel low roll resistance caster; black yoke; for use on hard floors or carpet.

Applicable on:
Setu Chairs

OC Caster

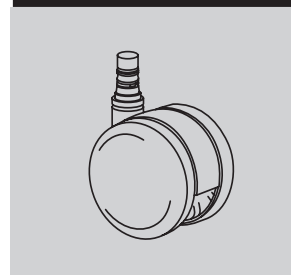

2¹/₂-inch-diameter double-wheel medium roll-resistant caster; black nylon wheels and yoke; soft polyurethane tread; for use on hard floors or carpet; quiet roll technology

Applicable on:
Cosm Chairs
Fuld Nesting Chairs
Setu Chairs

U4 Caster

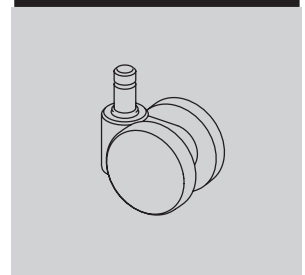

1⁷/₈-inch-diameter hard double-wheel caster; black nylon wheels and yoke; for use on carpet only

Applicable on:
Aside Chairs
Verus Chairs

Casters and Glides

continued

GSA

U5 Caster

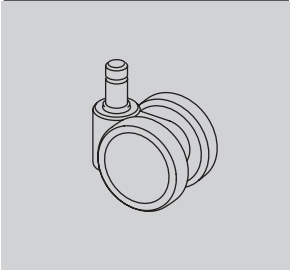

1⁷/₈-inch-diameter soft double-wheel caster; black nylon wheels and yoke; for use on hard floors or carpet

Applicable on:

Aside Chairs
Caper Chairs
Verus Chairs

VD Caster

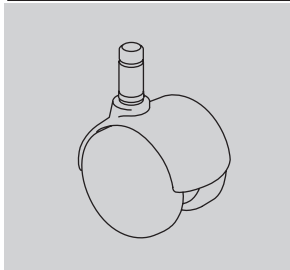

2-inch-diameter hard double-wheel caster; black nylon wheels with integral chrome hood; for use on carpet only

Applicable on:

Eames Aluminum Group

69 Glide

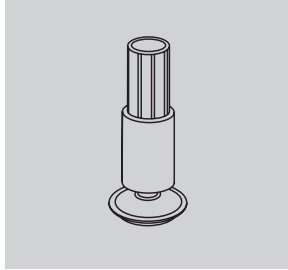

(Front glide shown)

2¹/₈-inch-high glide; black glass-filled nylon stem; steel-plated swivel foot with Floor Saver Glide® insert; for use on hard floors only

Applicable on:

Sayl Chairs

GD Glide

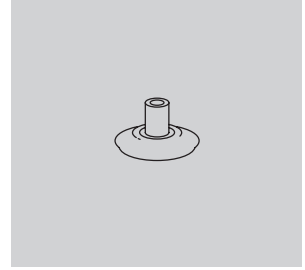

1¹/₂-inch-diameter glide; 1/2 inch in height; black nylon; for use on hard floors or carpet

Applicable on:

Eames Aluminum Group

UD Caster

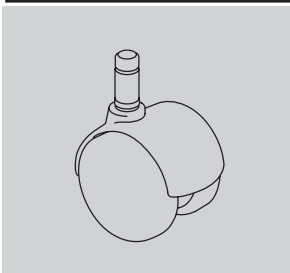

2-inch-diameter hard double-wheel caster; black nylon wheels with painted hood; for use on carpet only

Applicable on:

Eames® Aluminum Group

16 Glide

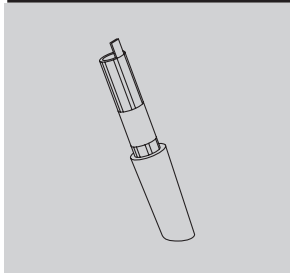

(Front glide shown)

2¹/₈-inch-high glide; black or fog acetal; for use on carpet only

Applicable on:

Sayl Chairs

G4 Glide

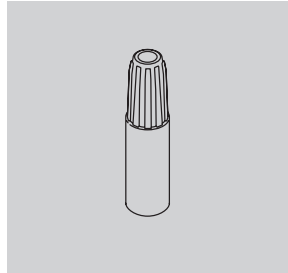

1⁷/₈-inch-high glide; black acetal; for use on carpet only

Applicable on:

Verus Chairs

GF Glide

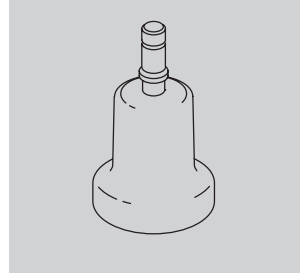

2¹/₂-inch-high glide; black nylon; for use on hard floors or carpet

Applicable on:

New Aeron Chairs
Caper Chairs
Cosm Chairs
Lino Chairs
Mirra 2 Chairs
Sayl Chairs
Verus Chairs

Casters and Glides

continued

GSA

GFG Glide

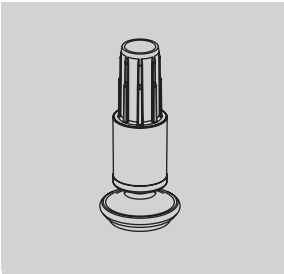

Floor Saver Glide™ insert; for use on hard floors only

Applicable on:

Zeph Chairs

GLN Glide

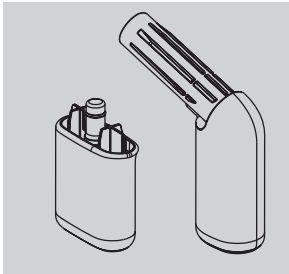

Acetal glide; for use on carpet only

Applicable on:

Fuld Nesting Chairs

HG Glide

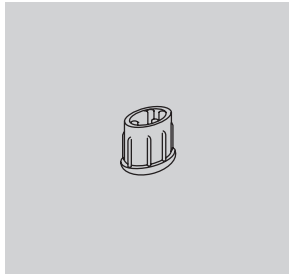

1/2-inch-high glide; black nylon glide with stainless-steel insert; for use on hard floors or carpet

Applicable on:

Aside Chairs

X8 Glide

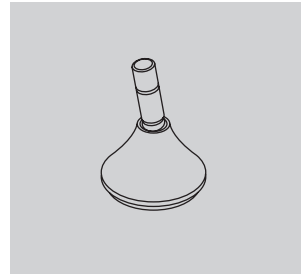

Glide; low profile; for use on hard floors or carpet

Applicable on:

Setu Chairs

GL Glide

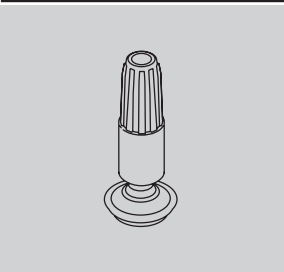

1 7/8-inch-high glide; black nylon stem; steel-plated swivel foot with Floor Saver Glide® insert; for use on hard floors only

Applicable on:

Verus Chairs

GNB Glide

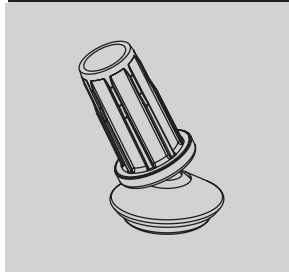

Swivel glide; nylon base; for use on carpet only

Applicable on:

Zeph Chairs

SG Glide (for Aside)

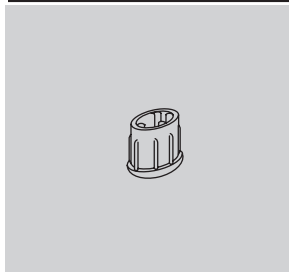

1/2-inch-high glide; black nylon; for use on carpet only

Applicable on:

Aside Chairs

XS Glide

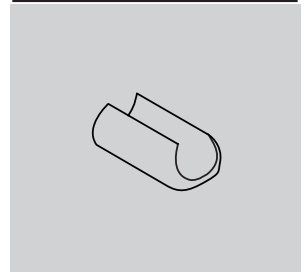

1/8-inch-high glide; polycarbonate in black, fog, clear, and studio white finishes; for use on hard floors or carpet

Applicable on:

Sayl Chairs

Casters and Glides

continued

GSA

Y7 Glide

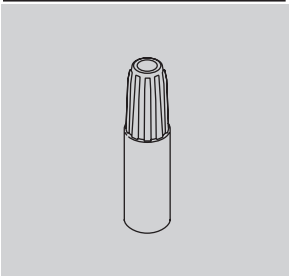

1⁷/₈-inch-high glide; black acetal; for use on carpet only

Applicable on:

Caper Chairs

YX Glide

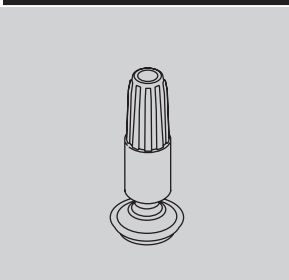

1⁷/₈-inch-high glide; black nylon stem; steel-plated swivel foot with Floor Saver Glide® insert; for use on hard floors only

Applicable on:

Caper Chairs



Textiles Application Chart — Seating GSA

• Available

[A] Assigned lead-time textile.

[A] Maharam textiles are on assigned lead times.

See following page for exception notes.

[N] Non-woven textile.

	Aeron® Chairs	Cosm™ Chairs	Mirra® 2 Chairs/Stools	Embody® Chairs	Fuld Nesting Chairs	Sayl® Work Chairs/Stools	Sayl Side Chairs	Setu® Chairs/Stools	Zeph® Chairs	Verus™ Work Chairs/Stools Back	Verus Work Chairs/Stools Seat	Verus Side Chairs Back	Verus Side Chairs Seat	Verus Plus Chairs	Aside® Chairs	Caper® Chairs/Stools	Lino™ Chairs Back	Lino Chairs Seat	OE1 Storage Trolley Cushion Top	Public® Office Landscape Back	Public Office Landscape Seat	Plex™ Lounge Furniture	Swoop™ Lounge Seating - Fully Upholstered	Swoop Lounge Seating - Plywood	Valor™ Seating	Cushion Tops	Workspaces	
Price Category 1																												
COM Customer's Own Material [A]						1	1			1	1	1	1	1	1			1	1		1	1	1	1	1	1	1	1
231__ 8Z Pellicle®	•																											
1A7__ AireWeave 2			•																									
8T__ Crossing								•							•				•									
3DE__ Dex						•	•	•		•	•	•	•	•	•				•									
4RM__ Duo																	•				•	19	•		•	•	•	
6V__ Flexnet™																•												
845__ Intercept		•																										
4W__ Lyris 2™								•																				
1MN__ Monologue						25	23	•		•	•	•						•	•		•	•	•	•	•	•	•	•
5H2__ Ripple 3D Knit									•																			
4SC__ Scatter						•	•	•		•	•	•	•	•	•			•	•		•	•	•	•		•	•	
5H1__ Splash 3D Knit									•									•	•		•	•	•	•		•	•	
3DK__ Stretch Knit						22																						
235__ Tailored						•	•	•		•	•	•	•	•	•			•			•	24			•	7	•	
9NK__ Tuck 3D Knit					•																							
1WS__ Whisper						25	•	•		•	•	•	•	•	•			•	•		•	•	•	•	•	•	•	•
Price Category 2																												
3AR__ Aristo						•	•	•		•	•	•	•	•	•			•	•		•	•	•	•	•	•	•	•
92__ Crepe						•	•	•		•	•	•	•	•	•			•	•		•	•	•	•	•	•	•	•
3EP__ Epic						•	•			•	•	•	•	•	•			•	•		•	•	•	•	•	•	•	•
3DP__ Hint						•	•			•	•	•	•	•	•			•	•		•	•	•	•	•	•	•	•
1MV__ Marvel [N]						22	23	•										•										
1HA__ Medley			•			•	23			•	•	•	•	•	•			•	•		•	•	•	•	•	•	•	•
4ME__ Mellow						•	23	•		•	•	•	•	•	•			•	•		•	•	•	•	•	•	•	•
ZMA__ Metaphor - Maharam [A]						16	16	•		•	•	•	•	•	•			•	•		•	•	•	•	•	•	•	•
8I1__ Muse - Maharam [A]						16	16			•	•	•	•	•	•			•	•		•	•	•	•	•	•	•	•
30__ Rhythm					24	•	•			•	•	•	•	•	•			•	•		•	•	•	•	•	•	•	•
3SL__ Sequel [N]						•	•	•		•	•	•	•	•	•	8		•	•		•	•	•	•	•	•	•	•
4TE__ Terra						•	23			•	•	•	•	•	•			•	•		•	•	•	•	•	•	•	•
8R__ Twist						•	•	•		•	•	•	•	•	•			•	•		•	•	•	•	•	•	•	•
Price Category 3																												
3AC__ Ace						22	•			•	•	•	•	•	8			•	•		•	19			•	•	•	
43Z__ Fractal						•	•	•		•	•	•	•	•	•			•				•	•	•	•	•	•	•
8M__ Latitude™						24																						
4GE__ Parcel						•	•	•		•	•	•	•	•	•			•				•	•	•	•	•	•	•
Price Category 4																												
3DM__ Daydream						22	•	•		•	•	•	•	•	•			•	•		•	•	•	•	•	•	•	•
3SY__ Sync						•	•	•		•	•	•	•	•	•			•			•	•	•	•	•	•	•	•
Price Category 5																												
3CY__ Cozy						•	•	•		•	•	•	•	•	•			•			•	•	•	•	•	•	•	•
14A__ Hopsak						•	•	•		•	•	•	•	•	•			•	•		•	•	•	•	•	•	•	•
40G__ Method - Maharam [A]						16	16	•		•	•	•	•	•	•			•	•		•	•	•	•	•	•	•	•
ZNC__ Nico - Maharam [A]						•	•			•	•	•	•	•	•			•	•		•	•	•	•	•	•	•	•
3SU__ Summit						•	•	•		•	•	•	•	•	•			•	•		•	•	•	•	•	•	•	•

Continued on next page

Textiles Application Chart — Seating

GSA continued

• Available

[A] Assigned lead-time textile.

[A] Maharam textiles are on assigned lead times.

See following page for exception notes.

[N] Non-woven textile.

	Aeron® Chairs	Cosm™ Chairs	Mirra® 2 Chairs/Stools	Embody® Chairs	Fuld Nesting Chairs	Sayl® Work Chairs/Stools	Sayl Side Chairs	Setu® Chairs/Stools	Zeph® Chairs	Verus™ Work Chairs/Stools Back	Verus Work Chairs/Stools Seat	Verus Side Chairs Back	Verus Side Chairs Seat	Verus Plus Chairs	Aside® Chairs	Caper® Chairs/Stools	Lino™ Chairs Back	Lino Chairs Seat	OE1 Storage Trolley Cushion Top	Public® Office Landscape Back	Public Office Landscape Seat	Plex™ Lounge Furniture	Swoop™ Lounge Seating - Fully Upholstered	Swoop Lounge Seating - Plywood	Valor™ Seating	Cushion Tops	Workspaces
Price Category 6																											
35__ Balance				•																							
Price Category 7																											
COL Customer's Own Leather [A]	1														8				1								1
Price Category 8																											
No fabrics available at this time																											
Price Category 9																											
ZGE__ Gemma - Maharam [A]						•	•	•		•	•	•	•	•	•			•			•	•	•	•	•	•	•
ZJA__ Jasper - Maharam [A]						16	16				•		•	•	•			•			•					•	7
21__ Leather [N]	24														8			•	•						•		•
Price Category 10																											
3KH__ Firma - Maharam [A]						16		•		•	•	•	•	•	•			•			•	•	•	•	•	•	•
ZGF__ Gemma Multi - Maharam [A]								•	•	•		•	•	•	•			•			•	•	•	•	•	•	•
ZGF__ Gemma Multi Reverse - Maharam [A]								•	•	•		•	•	•	•			•			•	•	•	•	•	•	•
ZP4__ Petra - Maharam [A]						16	16				•		•	•	•			•			•	•	•	•	•	•	•
Price Category A																											
No fabrics available at this time.																											
Price Category B																											
TI__ Messenger - Maharam [A] *								•	•	•		•	•	•	•			•	•			•	•	•	•	26	•
Price Category C																											
Z27__ Manner - Maharam [A]								•	•			•		•				•	•			•	•	•	•	•	•
887__ Merit - Maharam [A]								•	•			•	•	•	•			•	•			•	•	•	•	•	•
Z3__ Metric - Maharam [A]								•	•			•	•	•	•			•	•			•	•	•	•	•	•
8EY__ Murmur - Maharam [A]							16				•		•		•			•			•	•	•		•	7	
Price Category D																											
8I8__ Bluff - Maharam [N] [A]						16	16			•	•	•	•	•	8						•	21		•	•	•	
Price Category E																											
No fabrics available at this time.																											
Price Category F																											
82T__ Apt [N] - Maharam [A]						18	•				•	•								•	•			•	7		
74M__ Instill [N] - Maharam [A]						18	16			•	•	•	•					•			•	•		•	•	7	
89N__ Keen - Maharam [A]						16	16				•		•	•	•			•			•	•	•	•			
V9G__ Ledger - Maharam [A]						18	16			•	•	•	•					•	•						•	•	
ZLL__ Loop - Maharam [A]						16	16				•		•		8			•			•				•		
8LW__ Pepper - Maharam [A]						16	16				•		•		•			•			•	21		•		9	
Z33__ Strum - Maharam [N] [A]							16																•		•	7	

Continued on next page

* Available in select colors on 20-day lead-time. Refer to "Textile Colors" for 20-day colors.

Textiles Application Chart — Seating

GSA continued

• Available

[A] Assigned lead-time textile.

[A] Maharam textiles are on assigned lead times.

See following page for exception notes.

[N] Non-woven textile.

	Aeron® Chairs	Cosm™ Chairs	Mirra® 2 Chairs/Stools	Embody® Chairs	Fuld Nesting Chairs	Sayl® Work Chairs/Stools	Sayl Side Chairs	Setu® Chairs/Stools	Zeph® Chairs	Verus™ Work Chairs/Stools Back	Verus Work Chairs/Stools Seat	Verus Side Chairs Back	Verus Side Chairs Seat	Verus Plus Chairs	Aside® Chairs	Caper® Chairs/Stools	Lino™ Chairs Back	Lino Chairs Seat	OE1 Storage Trolley Cushion Top	Public® Office Landscape Back	Public Office Landscape Seat	Plex™ Lounge Furniture	Swoop™ Lounge Seating - Fully Upholstered	Swoop Lounge Seating - Plywood	Valor™ Seating	Cushion Tops	Workspaces
Price Category G																											
ZC2__ Compound - Maharam [N] [A]						16	16			•	•	•	•		8			•					•	•	•	•	7
8AR__ Gild - Maharam [A]							16				•	•	•	•							•	21	•	•	•		
Price Category H																											
ZT__ Circles - Maharam [A]						16	16																				•
ZK__ Dot Pattern - Maharam [A]						•	•	•		•		•			•				•							•	•
ZL__ Small Dot Pattern - Maharam [A]						•	•	•		•		•			•				•							•	•
Price Category I																											
7CW__ Cursive - Maharam [A]						16	16			•	•	•	•		8			•	•		•		•		•	•	
Price Category J-V																											
No fabrics available at this time.																											

Application Note: Herman Miller cannot guarantee material/pattern alignment in adjacent products. For example, a fabric's pattern may not align from one pedestal cushion top to the next, or from one chair to another.

- | | |
|---|---|
| <p>1 Refer to price book appendices and Omni for COM/COL information.</p> <p>7 Available on 1" Cushion Tops only.</p> <p>8 Only available on Aside non-upholstered outer back (PB) option.</p> <p>9 Available on Valor upholstered seat only.</p> <p>16 Available on Sayl Chair seat.</p> <p>18 Available on Sayl Chair seat and upholstered mid-back.</p> <p>19 Available on Plex seat only.</p> <p>20 Not available on Plex Club Chair with Headrest.</p> | <p>21 Available on Plex seat and on ottoman.</p> <p>22 Not available on Sayl upholstered back work chairs.</p> <p>23 Not available on Sayl side chairs with upholstered backs.</p> <p>24 Available in select colors. Refer to "Textile Colors" for color offering.</p> <p>25 Not available on Sayl upholstered High-Back Work Chairs.</p> <p>26 Available in select colors. Refer to "Textile Colors" for color offering.</p> |
|---|---|



Textile Colors

GSA

Price Category 1

Customer's Own Material
 Ancillary/Seating/Workspaces
 See Order Information in
 Appendices.
 Assigned lead-time textile. A

8Z Pellicle®
 Seating
 For New Aeron® Chairs
 56% elastomeric
 44% polyester
 23101 Mineral
 23102 Carbon
 23103 Graphite

AireWeave™ 2
 Seating
 For Mirra® 2 Chairs
 67% elastomeric
 33% antimony-free polyester
 1A701 Alpine
 1A702 Slate Grey
 1A703 Graphite
 1A704 Lime Green
 1A705 Cappuccino
 1A706 Urban Orange
 1A707 Dark Turquoise
 1A708 Twilight

Chain
 Workspaces
 66" wide
 100% recycled polyester
 with 12% ocean bound plastic
 2V01 Pearl
 2V02 Oyster
 2V03 Wheat
 2V04 Linen
 2V05 Wicker
 2V06 Bamboo
 2V07 Sage
 2V08 Spring Wood
 2V09 Iceberg

Crossing
 Seating/Workspaces
 54" wide
 86% antimony-free polyester
 14% polyester
 8T03 Wicker *
 8T04 Porcelain *
 8T05 Warm Grey *
 8T10 Tomato
 8T17 Cerulean
 8T18 Indigo
 8T19 Shale *
 8T22 Tin *
 8T23 Graphite
 8T24 Black

Crossing
 Workspaces
 For systems products only.
 54" wide
 86% antimony-free polyester
 14% polyester
 8501 Ivory *
 8502 Oyster *

* Crossing colors available
 on Exclave® Video-friendly
 Tackable Boards and Stowage
 Tackable Backdrop

Dex
 Seating/Workspaces
 54" wide
 67% recycled polyester
 33% polyester
 3DE01 Frost
 3DE02 Silver Pine
 3DE03 Stone
 3DE04 Shale
 3DE05 Charcoal
 3DE06 Gossamer
 3DE07 Pine

Duo
 Seating
 For Lino™ Chairs
 52% polyester
 48% elastomeric
 4RM01 Mineral
 4RM02 Poppy
 4RM03 Green Leaf
 4RM04 Jade
 4RM05 Shadow
 4RM06 Graphite

Flexnet™
 Seating
 For Caper® Chairs
 69% elastomeric
 31% polyester
 6V01 Black
 6V02 Silver Grey

Grasscloth
 Workspaces
 66" wide
 100% recycled polyester
 with 11% ocean bound plastic
 2I01 Silver Birch
 2I02 Pampas
 2I03 Sedge
 2I07 Lea
 2I08 Taro
 2I09 Steam Grey
 2I13 Gravel

Intercept
 Seating
 For Cosm™ Chairs
 60% elastomeric
 40% polyester
 84501 Graphite
 84502 Carbon
 84503 Mineral
 84504 Nightfall
 84505 Glacier
 84506 Canyon

Lyris 2™
 Seating
 For Setu® Chairs
 74% elastomeric
 26% polyester
 4W21 Alpine
 4W23 Chartreuse
 4W25 Berry Blue
 4W26 Slate Grey
 4W28 Chino
 4W31 Graphite

Monologue
 Ancillary/Seating/Workspaces
 54" wide
 56% recycled polyester
 44% polyester
 1MN01 Linen
 1MN02 Alabaster
 1MN04 Folkstone
 1MN05 Silver Pine
 1MN06 Slate
 1MN07 Seed
 1MN09 Persimmon
 1MN11 Meadow
 1MN12 Blue Sky
 1MN13 Blue Spruce
 1MN14 Deep Sea

Price category 1 continued on
 next page

Textile Colors

continued

GSA

Price Category 1

continued

Appendix: Textile Colors

Resonance	
Workspaces	
66" wide	
100% polyester	
5T04	Greige
5T05	Porcelain
5T06	Alabaster
5T15	Iris
5T28	Sugar
5T47	Tobacco
5T54	Saltbush
5T57	Seed
5T58	Sepia
5T60	Iceberg
5T65	Red
5T68	Pistachio
5T71	Jade
5T72	Blue Green
5T74	Twilight

Ripple 3D Knit	
Seating	
Available only on Zeph® Chairs.	
knit to size	
99% recycled polyester	
1% lycra	
5H201	Black
5H202	Carbon
5H203	Alpine
5H204	Silt
5H205	Tea Rose
5H206	Cocoa
5H207	Persimmon
5H208	Blaze
5H209	Cayenne
5H210	Falcon
5H211	Mustard Seed
5H212	Patina
5H213	Olive
5H214	Moss
5H215	Aloe
5H216	Glacier
5H217	Ultramarine
5H218	Nightfall
5H219	Bluebell
5H220	Boysenberry
5H221	Nightfall/Bluebell
5H222	Patina/Alpine
5H223	Cayenne/Glacier
5H224	Tea Rose/Olive
5H225	Silt/Blaze

Scatter	
Ancillary/Seating/Workspaces	
54" wide	
100% recycled polyester,	
with 26% ocean bound plastic	
4SC01	Alpine
4SC02	Fog
4SC03	Shale
4SC04	Persimmon
4SC07	Olive
4SC08	Glacier
4SC09	Blue Sky
4SC10	Lagoon
4SC11	Slate Grey
4SC12	Blue Black

Scribe	
Ancillary	
54" wide	
100% recycled polyester	
with 53% ocean bound plastic	
3DN01	Spring Wood
3DN02	Poplar
3DN03	Pewter
3DN04	Deep Sea
3DN05	Fir
3DN06	Nutmeg

Slant	
Workspaces	
66" wide	
51% polyester	
49% recycled polyester	
22F04	Pesto
22F06	Neptune
22F07	Blueberry
22F10	Pumpkin
22F12	Silver Birch
22F13	Bluestone
22F15	Shale

Splash 3D Knit	
Seating	
Available only on Zeph® Chairs.	
knit to size	
98% recycled polyester	
2% lycra	
5H101	Black
5H102	Carbon
5H103	Alpine
5H104	Silt
5H105	Tea Rose
5H106	Cocoa
5H107	Persimmon
5H108	Blaze
5H109	Cayenne
5H110	Falcon
5H111	Mustard Seed
5H112	Patina
5H113	Olive
5H114	Moss
5H115	Aloe
5H116	Glacier
5H117	Ultramarine
5H118	Nightfall
5H119	Bluebell
5H120	Boysenberry

Stretch Knit	
Seating	
Assigned lead-time textile. A	
Available only on Sayl®	
Suspension Back Work Chairs	
97% polyester, 3% spandex	
3DK01	Fog
3DK02	Slate Grey
3DK03	Java
3DK04	Black
3DK05	Red
3DK06	Green Apple
3DK07	Berry Blue

Price category 1 continued on next page

Textile Colors

continued

GSA

Price Category 1

continued

Tailored	
Ancillary/Seating/Workspaces	
54" wide	
56% polyester	
44% recycled polyester	
23501	Studio White * **
23502	Sugar **
23503	Tomato
23506	Chive
23508	Cobalt
23509	Cadet
23510	Fog
23511	Graphite
23512	Black
23513	Coffee

* Color not available on Canvas Tiles.
 ** Colors not available on Plex™ Lounge Furniture.

Tuck 3D Knit	
Seating	
Available only on Fuld Nesting Chairs.	
knit to size	
56% polyester	
44% recycled polyester	
9NK01	Alpine
9NK02	Carbon
9NK03	Nightfall
9NK04	Olive
9NK05	Cocoa
9NK06	Canyon

Whisper	
Ancillary/Seating/Workspaces	
54" wide	
73% recycled polyester	
27% polyester,	
with 11.3% ocean bound plastic	
1WS01	Sand Dollar
1WS02	Pebble
1WS03	Silver Birch
1WS04	Iceberg
1WS05	Silver Pine
1WS06	Carbon
1WS07	Cumin
1WS12	Willow
1WS13	Sea Grass
1WS14	Pool
1WS15	Blueberry
1WS16	Glacier
1WS17	Grey
1WS18	Canyon

Price Category 2

Aristo	
Seating/Workspaces	
54" wide	
88% recycled polyester	
12% polyester	
Acrylic backing	
3AR01	Forest Moss
3AR02	Light Brindle
3AR03	Mink
3AR04	Copper
3AR06	Cherry
3AR08	Green Apple
3AR10	Waterfall
3AR11	Cadet
3AR12	Tin
3AR13	Pewter
3AR14	Grey Brindle
3AR15	Grey Black

Cord	
Workspaces	
66" wide	
51% antimony-free polyester	
49% polyester	
5101	Ivory
5102	White Ash
5103	Linen
5104	Bamboo
5105	Sepia
5107	Sesame
5109	Bayou
5111	Spring Wood
5112	Summer White

Crepe	
Ancillary/Seating/Workspaces	
54" wide	
100% recycled polyester,	
with 43.6% ocean bound plastic	
9201	Licorice
9203	Smoke
9207	Cherry
9223	Cadet
9241	Beachglass
9249	Stone *
9251	Fog *
9252	Slate Grey
9261	Shale
9262	Graphite
9265	Mineral
9266	Persimmon
9267	Juniper
9268	Glacier
9269	Cascade
9270	Navy

* Colors available on Exclave® Video-friendly Tackable Boards and Stowage Tackable Backdrop

Epic	
Seating/Workspaces	
54" wide	
56% recycled polyester	
44% polyester	
Acrylic backing	
3EP01	Alabaster
3EP02	Smoke
3EP03	Falcon
3EP05	Copper
3EP06	Urban Orange
3EP07	Poppy
3EP10	Clover
3EP11	Loden
3EP14	Peacock
3EP15	Cadet
3EP16	Indigo
3EP17	Spring Wood
3EP18	Grey Brindle
3EP19	Seed
3EP20	Carbon Dark

Price category 2 continued on next page

Textile Colors

continued

GSA

Price Category 2

continued

Appendix: Textile Colors

Hint	
Seating/Workspaces	
54" wide	
76% recycled polyester	
24% polyester	
3DP01	Sediment
3DP02	Gunmetal
3DP03	Silt
3DP04	Porcelain
3DP05	Indigo
3DP06	Fern
3DP07	Adobe
3DP08	Red Sea

Horizon	
Workspaces	
54" wide	
65% antimony-free polyester	
35% polyester	
4N01	Rye Grass
4N02	Sugar Pine
4N03	Silver Pine
4N04	White Ash
4N05	Spring Wood
4N08	Haystack
4N09	Oat Grass
4N13	Pine Cone
4N15	Elderberry

Marvel	
Seating	
54" wide	
100% pvc-free polyurethane	
1MV01	Summer White
1MV02	Sand Dollar
1MV03	Espresso
1MV04	Folkstone Grey
1MV05	Graphite
1MV06	Onyx
1MV07	Polar Blue
1MV08	Blush Grey
1MV12	Red
1MV14	Pine
1MV15	Teal Green
1MV16	Twilight

Medley	
Ancillary/Seating/Workspaces	
54" wide	
100% polyester	
1HA01	Stone *
1HA02	Trail
1HA03	Charcoal
1HA04	Cinder
1HA05	Citrus
1HA06	Papaya
1HA07	Chutney
1HA08	Tundra
1HA09	Feather Grey *
1HA10	Chartreuse
1HA11	Loden
1HA12	Peacock
1HA13	Bayou *
1HA14	Blue Grotto
1HA15	Blueberry
1HA22	Khaki
1HA23	Pewter
1HA24	Yellow Oxide
1HA25	Vintage Rose
1HA26	Raspberry
1HA27	Acai Berry

* Colors available on Exclave®
Video-friendly Tackable Boards
and Stowage Tackable Backdrop

Mellow	
Seating/Workspaces	
54" wide	
100% recycled polyester, with 16% ocean bound plastic	
4ME01	Mineral
4ME04	Olive
4ME05	Glacier
4ME06	Oceanside
4ME07	Charcoal

Metaphor – Maharam	
Ancillary/Seating/Workspaces	
54" wide	
100% polyester	
Acrylic backing	
ZMA01/466553-001	Afterfeather
ZMA02/466553-002	Moonflower
ZMA03/466553-003	Handcraft
ZMA04/466553-004	Crossroad
ZMA05/466553-005	Chondrite
ZMA06/466553-006	Detective
ZMA07/466553-007	Steamship
ZMA08/466553-008	Electricity
ZMA09/466553-009	Takeoff
ZMA10/466553-010	Parachute
ZMA11/466553-011	Blueshift
ZMA12/466553-012	Dockyard
ZMA13/466553-013	Bathe
ZMA14/466553-014	Icebound
ZMA15/466553-015	Thermosphere
ZMA16/466553-016	Aboard
ZMA17/466553-017	Agateware
ZMA18/466553-018	Homeland
ZMA19/466553-019	Rockfall
ZMA20/466553-020	Undergrowth
ZMA21/466553-021	Gremolata
ZMA22/466553-022	Patina
ZMA23/466553-023	Sylvan
ZMA24/466553-024	Outfield
ZMA25/466553-025	Windbreak
ZMA26/466553-026	Saguaro
ZMA27/466553-027	Barnwood
ZMA28/466553-028	Cookshop
ZMA29/466553-029	Amandine
ZMA30/466553-030	Bodhran
ZMA31/466553-031	Centerstage
ZMA32/466553-032	Focaccia
ZMA33/466553-033	Bumblebee
ZMA34/466553-034	Microbrew
ZMA35/466553-035	Sauna
ZMA36/466553-036	Gazebo
ZMA37/466553-037	Pirouette
ZMA38/466553-038	Heartbeat
ZMA39/466553-039	Shino
ZMA40/466553-040	Sunrise

Metaphor continued	
ZMA41/466553-041	Florist
ZMA42/466553-042	Beadwork
ZMA43/466553-043	Framboise
ZMA44/466553-044	Wisteria
ZMA45/466553-045	Warrior

Muse – Maharam	
Ancillary/Seating/Workspaces	
54" wide	
100% post-consumer recycled polyester	
8I101/466487-001	Crescendo
8I102/466487-002	Resonate
8I103/466487-003	Runway
8I104/466487-004	Ascend
8I105/466487-005	Veil
8I106/466487-006	Refresh
8I107/466487-007	Clear
8I108/466487-008	Fantasy
8I109/466487-009	Miso
8I110/466487-010	Compass
8I111/466487-011	Bergamot
8I112/466487-012	Grasshopper
8I113/466487-013	Goal
8I114/466487-014	Mistletoe
8I115/466487-015	Seaglass
8I116/466487-016	Frigid
8I117/466487-017	Riverbend
8I118/466487-018	Noble
8I119/466487-019	Pulsar
8I120/466487-020	Velella
8I121/466487-021	Sailboat
8I122/466487-022	Sparse
8I123/466487-023	Vase
8I124/466487-024	Haven
8I125/466487-025	Mead
8I126/466487-026	Neat
8I127/466487-027	Jovial
8I128/466487-028	Theater
8I129/466487-029	Poinsettia
8I130/466487-030	Celebrate
8I131/466487-031	Spectacle

Price category 2 continued on
next page

Textile Colors

continued

GSA

Price Category 2

continued

Rhythm

Seating	
54" wide	
100% polyester	
3002	Green Apple
3004	Bayou
3005	Berry Blue
3006	Iris
3007	Twilight
3009	Poppy
3010	Molasses
3012	Khaki
3013	Mink
3014	Black *
3015	Charcoal *

* Colors available on Embody® Chair

Sequel

Ancillary/Seating/Workspaces	
54" wide	
100% vinyl	
100% polyester knit backing	
Resilience® finish	
3SL01	White
3SL02	Pebble
3SL03	Mushroom
3SL04	Stone
3SL06	Rattan
3SL09	Seal
3SL10	Blue Fog
3SL11	Folkstone
3SL12	Shale
3SL13	Slate Grey
3SL14	Charcoal
3SL15	Carbon Dark
3SL28	Navy *

* Color available on Eames® Tandem Sling Seating

Terra

Ancillary/Seating/Workspaces	
54" wide	
100% post-consumer recycled biodegradable polyester *	
4TE01	Spring Wood
4TE02	Zinc
4TE03	Pine Cone
4TE04	Charcoal
* 1% biodegradation in 1,278 days under ASTM D5511 conditions. No evidence of further degradation.	

Twine

Workspaces	
66" wide	
100% recycled polyester	
3TW01	Silver Birch
3TW02	Ivory
3TW03	Alabaster
3TW04	Bamboo
3TW05	Iceberg
3TW06	Charcoal
3TW07	Feather Grey
3TW08	Shale

Twist

Ancillary/Seating/Workspaces	
54" wide	
80% antimony-free polyester	
13% recycled polyester	
7% polyester	
8R05	Wicker
8R10	Poppy
8R14	Tin
8R15	Shale
8R16	Graphite
8R17	Birch
8R18	Sepia
8R22	Blueberry
8R23	Green Apple
8R26	Gunmetal
8R27	Cinder
8R29	Pekoe
8R33	Forest
8R35	Waterfall
8R36	Midnight Blue
8R37	Carbon Dark

Twist

Workspaces	
For systems products only.	
54" wide	
80% antimony-free polyester	
13% recycled polyester	
7% polyester	
5S03	Oyster

Price Category 3

Ace

Ancillary/Seating	
54" wide	
100% polyurethane	
Polyester knit backing	
Stain resistant finish	
3AC01	Summer White
3AC02	White Ash
3AC03	Rye
3AC04	Metal
3AC05	Clay
3AC06	Chestnut
3AC08	Camelback
3AC09	Chipotle
3AC12	Artichoke
3AC13	Sepia Dark
3AC14	Aloe
3AC15	Flint
3AC16	Blue Sky
3AC17	Oceanside
3AC18	Midnight
3AC20	Frost
3AC21	Lead
3AC22	Black

Fractal

Ancillary/Seating/Workspaces	
58" wide	
84% recycled polyester	
16% polyester	
43Z01	Granite
43Z02	Golden Olive
43Z03	Verdant
43Z04	Cadet

Price category 3 continued on next page

Textile Colors

continued

GSA

Price Category 3

continued

Ground Cloth®	
Workspaces	
66" wide	
100% polyester	
4701	Vapor Grey
4721	Warm White *
4722	Fog *
4723	Straw *
4724	Red Orange *
4726	Green Apple *
4727	Caribbean *
4728	Midnight *
4729	Cappuccino *

* Colors available on Exclave®
Video-friendly Tackable Boards
and Stowage Tackable Backdrop

Latitude	
Seating	
Colors for Mirra 2 Chairs	
100% polyester	
8M10	Alpine
8M17	Black
8M21	Slate Grey
8M23	French Press
8M25	Dark Turquoise
8M26	Twilight

Meld – Maharam	
Workspaces	
54" wide	
68% post-consumer recycled polyester	
32% polyester	
PFOA-Free stain resistant	
ZM201/466387-201	Vast
ZM202/466387-202	Panda **
ZM203/466387-203	Skyline *
ZM204/466387-204	Knight **
ZM205/466387-205	Quill **
ZM206/466387-206	Pipe
ZM207/466387-207	Grate *
ZM208/466387-208	Gloss
ZM209/466387-209	Bulb
ZM210/466387-210	Bride
ZM211/466387-211	Stark
ZM212/466387-212	Seashell
ZM213/466387-213	Antler

Meld continued	
ZM214/466387-214	Crater *
ZM215/466387-215	Perennial
ZM216/466387-216	Mulberry
ZM217/466387-217	Fuchsia *
ZM218/466387-218	Amethyst *
ZM219/466387-219	Merlot
ZM220/466387-220	Magma *
ZM221/466387-221	Rooster
ZM222/466387-222	Heat *
ZM223/466387-223	Clementine
ZM224/466387-224	Fox
ZM225/466387-225	Kiss *
ZM226/466387-226	Bare
ZM227/466387-227	Blonde
ZM228/466387-228	Mimosa
ZM229/466387-229	Comet *
ZM230/466387-230	Honeydew
ZM231/466387-231	Wild *
ZM232/466387-232	Vine
ZM233/466387-233	Seed
ZM234/466387-234	Kale *
ZM235/466387-235	Waterfall *
ZM236/466387-236	Nordic *
ZM237/466387-237	Reef *
ZM238/466387-238	Wave
ZM239/466387-239	Isle **
ZM240/466387-240	Creek
ZM241/466387-241	Mariner *
ZM242/466387-242	Globe
ZM243/466387-243	Spa

* Colors available on
20-day lead time.
** Colors available on
10-day lead time.

Parcel	
Ancillary/Seating/Workspaces	
54" wide	
100% recycled polyester	
4GE01	Gunmetal
4GE02	Brindle
4GE03	Bayou
4GE04	Pesto
4GE05	Golden Olive
4GE06	Copper Sea

Saille - Geiger Textile	
Ancillary	
57" wide	
69% cotton	
31% polyester	
PFOA-Free stain resistant finish	
Acrylic backing	
18001	Coal
18002	Shale
18003	Haze
18004	Stone
18005	White *
18006	Beach
18007	Sand
18008	Blush
18009	Brick
18010	Fog
18011	Celadon
18012	Poolside
18013	Summer Sky
18014	Lake
18015	Midnight Blue

* Color not available on Eames®
Soft Pad Group Chairs/Ottomans.

Strands	
Workspaces	
66" wide	
100% recycled polyester	
8W01	Pebble
8W02	Porcelain
8W03	Taupe
8W04	Honey
8W05	Khaki
8W06	Rye
8W07	Wicker
8W08	Tin
8W09	Cool Grey

Price Category 4

Cygnus	
Ancillary	
For Eames® Aluminum Group Chairs	
69% elastomeric	
31% polyester	
5401	Black
5402	Zinc
5403	Quartz

Daydream	
Ancillary/Seating	
54" wide	
48% wool	
41% recycled polyester	
9% nylon	
2% polyester	
3DM01	Rye Grass
3DM02	Silver Birch
3DM03	Pewter
3DM04	Graphite
3DM05	Black
3DM06	Lemongrass
3DM07	Permission
3DM08	Juniper
3DM09	Sea Grass
3DM10	Nightfall

Kalista - Geiger Textile	
Ancillary	
54" wide	
71% post-industrial recycled cotton	
18% post-industrial recycled polyester	
11% polyester	
PFOA-Free stain resistant finish	
1AL01	Cotton
1AL02	Natural
1AL03	Titanium
1AL04	Pewter
1AL05	Starry Night
1AL06	Red Hot
1AL07	Sun Kissed
1AL08	Dune
1AL09	Beach Glass
1AL10	Bluestone
1AL11	Seaside
1AL12	Night Sky

Price category 4 continued on
next page

Textile Colors

continued

GSA

Price Category 4

continued

Lariat – Maharam	
Ancillary/Seating 54" wide 100% vinyl	
ZLR01/440401-001	001
ZLR02/440401-002	002
ZLR04/440401-004	004
ZLR06/440401-006	006
ZLR07/440401-007	007
ZLR08/440401-008	008
ZLR10/440401-010	010
ZLR11/440401-011	011
ZLR13/440401-013	013
ZLR14/440401-014	014
ZLR15/440401-015	015
ZLR16/440401-016	016
ZLR18/440401-018	018
ZLR20/440401-020	020
ZLR21/440401-021	021
ZLR24/440401-024	024
ZLR25/440401-025	025
ZLR26/440401-026	026
ZLR28/440401-028	028
ZLR31/440401-031	031
ZLR32/440401-032	032
ZLR33/440401-033	033
ZLR34/440401-034	034
ZLR38/440401-038	038
ZLR39/440401-039	Granite
ZLR40/440401-040	Linen
ZLR41/440401-041	Stella
ZLR42/440401-042	Saddle
ZLR43/440401-043	Holly
ZLR44/440401-044	Maroon
ZLR45/440401-045	Siren
ZLR46/440401-046	Reseda
ZLR47/440401-047	Purslane
ZLR48/440401-048	Spire
ZLR49/440401-049	Papyrus
ZLR50/440401-050	Chickadee
ZLR51/440401-051	Requiem

Sync	
Ancillary/Seating 55" wide 100% polyester	
3SY01	Pine Cone
3SY03	Canyon
3SY04	Truffle
3SY06	Everglade
3SY08	Nightfall
3SY09	Dark Mineral
3SY10	Slate Grey
3SY11	Dark Carbon
3SY12	Black

Price Category 5

Cozy	
Ancillary/Seating 54" wide 100% wool	
3CY01	Heathered Warm Grey
3CY02	Heathered Rye Grass
3CY03	Heathered Cool Grey
3CY05	Heathered Black
3CY06	Heathered Persimmon
3CY07	Heathered Loden
3CY09	Heathered Lagoon
3CY10	Heathered Twilight

Hopsak	
Ancillary/Seating/Workspaces 56" wide 100% recycled polyester	
14A20	Black
14A22	Raw Umber Dark
14A26	Grey Blue Dark
14A30	Sepia Dark
14A38	Emerald Dark
14A39	Yellow Dark
14A40	Orange
14A41	Sienna
14A42	Olive Green Dark
14A43	Crimson
14A44	Crimson Dark Dark
14A45	Violet Dark
14A46	Pink Dark Dark
14A47	Ultramarine Dark
14A48	Cobalt Blue
14A49	Terra Cotta
14A50	Ochre Dark

Ingenu - Geiger Textile	
Ancillary 54" wide 28% wool 26% viscose 25% acrylic 16% polyester 5% cotton PFOA-Free stain resistant finish	
1GH01	Sand
1GH02	Fog
1GH03	Flannel
1GH04	Trench
1GH05	Vermillion
1GH06	Adriatic
1GH07	Umber
1GH08	Charcoal

Method – Maharam	
Seating/Workspaces 54" wide 100% recycled polyester with 12% ocean-bound plastic	
40G01/466579-001	Inspire
40G02/466579-002	Rhea
40G03/466579-003	Noise
40G04/466579-004	Speedway
40G05/466579-005	Villanelle
40G06/466579-006	Maestro
40G07/466579-007	Destiny
40G08/466579-008	Possess
40G09/466579-009	Waterside
40G10/466579-010	Relax
40G11/466579-011	Delightful
40G12/466579-012	Parrotlet
40G13/466579-013	Verdurous
40G14/466579-014	Bosky
40G15/466579-015	Acreage
40G16/466579-016	Allude
40G17/466579-017	Tweed
40G18/466579-018	Korma
40G19/466579-019	Fossilize
40G20/466579-020	Cattail

Price category 5 continued on next page

Textile Colors

continued

GSA

Appendix: Textile Colors

Price Category 5

continued

Method continued

40G21/466579-021 Shortcake
 40G22/466579-022 Racecar
 40G23/466579-023 Courtship
 40G24/466579-024 Jam
 40G25/466579-025 Sparrow

Nico - Maharam

Ancillary/Seating/Workspaces
 54" wide
 63% wool
 21% polyester
 16% solution-dyed nylon

ZNC01/466564-001 Alcazar
 ZNC02/466564-002 Ironclad
 ZNC03/466564-003 Tune
 ZNC04/466564-004 Bridegroom
 ZNC05/466564-005 Diode
 ZNC06/466564-006 Jest
 ZNC07/466564-007 Sanctuary
 ZNC08/466564-008 Aquarius
 ZNC09/466564-009 Houseboat
 ZNC10/466564-010 Olympian
 ZNC11/466564-011 Tennis
 ZNC12/466564-012 Dressage
 ZNC13/466564-013 Zing
 ZNC14/466564-014 Bitterroot
 ZNC15/466564-015 Gemini
 ZNC16/466564-016 Posh
 ZNC17/466564-017 Sizzle
 ZNC18/466564-018 Cheerful
 ZNC19/466564-019 Watermelon
 ZNC20/466564-020 Toucan
 ZNC21/466564-021 Rosin
 ZNC22/466564-022 Jousting
 ZNC23/466564-023 Jojoba
 ZNC24/466564-024 Dromedary
 ZNC25/466564-025 Toasty
 ZNC26/466564-026 Casaba
 ZNC27/466564-027 Greenhouse
 ZNC28/466564-028 Sibyl
 ZNC29/466564-029 Spearmint
 ZNC30/466564-030 Pothos
 ZNC31/466564-031 Calathea
 ZNC32/466564-032 Landscape
 ZNC33/466564-033 Espalier
 ZNC34/466564-034 Gecko
 ZNC35/466564-035 Meditation

Summit

Ancillary/Seating
 54" wide
 100% silicone
 Polyester knit backing
 3SU02 Oyster
 3SU03 Zinc
 3SU04 Sparrow
 3SU07 Black
 3SU09 Beachglass
 3SU10 Midnight

Vionette - Geiger Textile

Ancillary
 55" wide
 100% polyester
 1GJ01 White Sand Mix
 1GJ02 Desert Mix
 1GJ03 Light Gray Mix
 1GJ04 Pewter Mix
 1GJ05 Cobalt Mix
 1GJ06 Prussian Blue Mix
 1GJ07 Chocolate Mix
 1GJ08 Champagne
 1GJ09 Morning Sky
 1GJ10 Aquatic
 1GJ11 Sapphire
 1GJ12 Midnight Blue
 1GJ13 Shadow
 1GJ14 Java
 1GJ15 Carbon
 1GJ16 Black
 1GJ17 Claret
 1GJ18 Poppy

Price Category 6

Balance

Seating
 For Embody® chairs
 100% polyester
 3512 Carbon
 3513 Black

Outdoor Weave

Ancillary
 For Eames® Aluminum Group
 Outdoor Chairs
 50% elastomeric
 50% polypropylene
 7203 Lead
 7205 Graphite

Price Category 7

Customer's Own Leather

Seating/Ancillary
 See Order Information in
 Appendices. Assigned lead-time
 textile. [A](#)

Beck – Maharam

Ancillary/Seating
 55" wide
 78% wool
 22% nylon
 ZB301/466571-001 Overshadow
 ZB302/466571-002 Molecule
 ZB303/466571-003 Zeitgeist
 ZB304/466571-004 Blacksmith
 ZB305/466571-005 Cornerstone
 ZB306/466571-006 Chainmail
 ZB307/466571-007 Buckram
 ZB308/466571-008 Callisto
 ZB309/466571-009 Interlude
 ZB310/466571-010 Letterpress
 ZB311/466571-011 Memoir
 ZB312/466571-012 Litmus
 ZB313/466571-013 Stoic
 ZB314/466571-014 Inkpad
 ZB315/466571-015 Praxis
 ZB316/466571-016 Astute
 ZB317/466571-017 Percolate
 ZB318/466571-018 Halocline
 ZB319/466571-019 Semblance
 ZB320/466571-020 Loch
 ZB321/466571-021 Lido
 ZB322/466571-022 Underwater
 ZB323/466571-023 Tetrapod
 ZB324/466571-024 Nymph
 ZB325/466571-025 Appalachian

Price category 7 continued on
 next page

Textile Colors

continued

GSA

Price Category 7

continued

Beck continued

ZB326/466571-026	Menthol
ZB327/466571-027	Woodruff
ZB328/466571-028	Malachite
ZB329/466571-029	Botanist
ZB330/466571-030	Woodlet
ZB331/466571-031	Katydid
ZB332/466571-032	Exuberant
ZB333/466571-033	Retrospect
ZB334/466571-034	Lambic
ZB335/466571-035	Argil
ZB336/466571-036	Brushstroke
ZB337/466571-037	Candescent
ZB338/466571-038	Reedbuck
ZB339/466571-039	Clayware
ZB340/466571-040	Curio
ZB341/466571-041	Whimsy
ZB342/466571-042	Effervescent
ZB343/466571-043	Lingonberry
ZB344/466571-044	Resplendent
ZB345/466571-045	Hollyhock
ZB346/466571-046	Filigree
ZB347/466571-047	Plutonic
ZB348/466571-048	Foundry
ZB349/466571-049	Patisserie
ZB390	Gold 007/032/033 *
ZB391	Russet 036/040/039 *
ZB392	Indigo 008/013/014 *
ZB393	Forest 006/031/028 *

* Colors available only on Girard Color Wheel Ottoman.

Bellano - Geiger Textile

Ancillary	
55" wide	
75% wool	
10% linen	
8% nylon	
7% alpaca	
1AX01	Pearl
1AX02	Fog
1AX03	Fawn
1AX04	Pumice
1AX05	Pewter
1AX06	Atlantic
1AX07	Black Green
1AX08	Adriatic
1AX09	Coffee
1AX10	Charcoal
1AX11	Umber
1AX12	Magenta
1AX13	Bittersweet
1AX14	Sunflower

Capri - Geiger Textile

Ancillary	
55" wide	
36% cotton	
32% acrylic	
24% rayon	
8% polyester	
PFOA-Free stain resistant finish	
Acrylic backing	
17201	Snow
17202	Stone
17203	Trench
17204	Graphite
17205	Anthracite
17206	Light Silver
17207	Russet
17208	Chestnut Brown
17209	Sand
17210	Sterling
17211	Cobalt
17212	Ink

Milaner - Geiger Textile

Ancillary	
55" wide	
56% wool, 10% acrylic	
10% alpaca, 10% cotton	
8% nylon, 6% rayon	
17101	Linen
17102	Flax
17103	Bark
17104	Deep Navy
17105	Charcoal
17106	Medium Grey
17107	Ash
17108	Crimson

Panno di Dolce - Geiger Textile

Ancillary	
55" wide	
65% wool	
20% nylon	
15% alpaca	
1AV01	Fog
1AV02	Dune
1AV03	Trench
1AV04	Flannel
1AV05	Charcoal
1AV06	Umber
1AV07	Deep Navy
1AV08	Graphite
1AV09	Orange
1AV10	Pink
1AV11	Deep Red
1AV12	Bright Green
1AV13	Cerulean Blue
1AV14	Deep Cerulean Blue

Resca - Geiger Textile

Ancillary	
56" wide	
75% wool	
10% linen	
8% nylon	
7% alpaca	
1AW01	Fog
1AW02	Dune
1AW03	Trench
1AW04	Flannel
1AW05	Umber
1AW06	Bordeaux

Wool Tweed - Geiger Textile

Ancillary	
54" wide	
80% wool, 20% nylon	
16601	Trench
16602	Pewter
16603	Ruby
16604	Blue Gray
16605	Navy
16606	Umber
16607	Charcoal

Textile Colors

continued

GSA

Appendix: Textile Colors

Price Category 8

Luce - Maharam	
Ancillary/Seating	
59" wide	
75% post-consumer recycled wool	
20% polyester	
5% nylon	
ZLU01/466566-001	Brioche
ZLU02/466566-002	Blanched
ZLU03/466566-003	Relic
ZLU04/466566-004	Sinter
ZLU05/466566-005	Scoria
ZLU06/466566-006	Austere
ZLU07/466566-007	Pigment
ZLU08/466566-008	Alkali
ZLU09/466566-009	Tidal
ZLU10/466566-010	Imbue
ZLU11/466566-011	Reservoir
ZLU12/466566-012	Brine
ZLU13/466566-013	Undertone
ZLU14/466566-014	Prelude
ZLU15/466566-015	Submerge
ZLU16/466566-016	Cypress
ZLU17/466566-017	Awash
ZLU18/466566-018	Adriatic
ZLU19/466566-019	Province
ZLU20/466566-020	Virescent
ZLU21/466566-021	Nettle
ZLU22/466566-022	Agrarian
ZLU23/466566-023	Serpentine
ZLU24/466566-024	Laurel
ZLU25/466566-025	Clarion
ZLU26/466566-026	Gooseberry
ZLU27/466566-027	Swelter
ZLU28/466566-028	Etruscan
ZLU29/466566-029	Coulis
ZLU30/466566-030	Rubescient
ZLU31/466566-031	Akoya
ZLU32/466566-032	Radiant
ZLU33/466566-033	Regent
ZLU34/466566-034	Spectral
ZLU35/466566-035	Thistle

Price Category 9

Gemma – Maharam	
Ancillary/Seating	
55" wide	
85% wool	
15% nylon	
ZGE01/466568-001	Crinoline
ZGE02/466568-002	Angelic
ZGE03/466568-003	Savory
ZGE04/466568-004	Honeycomb
ZGE05/466568-005	Gilded
ZGE06/466568-006	Paddleboat
ZGE07/466568-007	Stagecoach
ZGE08/466568-008	Waterbuck
ZGE09/466568-009	Earnest
ZGE10/466568-010	Auric
ZGE11/466568-011	Carmine
ZGE12/466568-012	Serape
ZGE13/466568-013	Ferric
ZGE14/466568-014	Canyon
ZGE15/466568-015	Alembic
ZGE16/466568-016	Patio
ZGE17/466568-017	Sorrel
ZGE18/466568-018	Root
ZGE19/466568-019	Mansion
ZGE20/466568-020	Buff
ZGE21/466568-021	Starch
ZGE22/466568-022	Dawn
ZGE23/466568-023	Countryside
ZGE24/466568-024	Dewy
ZGE25/466568-025	Reliquary
ZGE26/466568-026	Deluge
ZGE27/466568-027	Overlay
ZGE28/466568-028	Electron
ZGE29/466568-029	Sheath
ZGE30/466568-030	Quietude
ZGE31/466568-031	Jargon
ZGE32/466568-032	Powder
ZGE33/466568-033	Tide
ZGE34/466568-034	Outwash
ZGE35/466568-035	Enamored
ZGE36/466568-036	Smitten
ZGE37/466568-037	Revere
ZGE38/466568-038	Mangosteen
ZGE39/466568-039	Allium
ZGE40/466568-040	Immense

Gemma continued	
ZGE41/466568-041	Chamber
ZGE42/466568-042	Cosmos
ZGE43/466568-043	Inkling
ZGE44/466568-044	Rainwater
ZGE45/466568-045	Shade
ZGE46/466568-046	Pendant
ZGE47/466568-047	Axial
ZGE48/466568-048	Fervent
ZGE49/466568-049	Legacy
ZGE50/466568-050	Caliber
ZGE51/466568-051	Temple
ZGE52/466568-052	Evenfall

Jasper - Maharam	
Seating	
53" wide	
55% wool	
27% solution-dyed nylon	
18% cotton	
ZJA01/466563-001	Thrill
ZJA02/466563-002	Anise
ZJA03/466563-003	Grapefruit
ZJA04/466563-004	Lifeguard
ZJA05/466563-005	Heartfelt
ZJA06/466563-006	Corsage
ZJA07/466563-007	Earthenware
ZJA08/466563-008	Bear
ZJA09/466563-009	Firelight
ZJA10/466563-010	Dreamcatcher
ZJA11/466563-011	Bobcat
ZJA12/466563-012	Glacial
ZJA13/466563-013	Vaporize
ZJA14/466563-014	Trapdoor
ZJA15/466563-015	Halcyon
ZJA16/466563-016	Observatory
ZJA17/466563-017	Steamboat
ZJA18/466563-018	Aquathlon
ZJA19/466563-019	Cloudless
ZJA20/466563-020	Briny
ZJA21/466563-021	Magical
ZJA22/466563-022	Picnic
ZJA23/466563-023	Herbage
ZJA24/466563-024	Pasture
ZJA25/466563-025	Courtyard
ZJA26/466563-026	Leapfrog

Leather	
Ancillary/Seating	
approx. 50 sq. ft. per hide	
100% leather	
2101	Ivory
2109	Black *
2110	Smoke
2111	Graphite
2112	Khaki
2113	Rattan
2114	Truffle
2115	Alpine
2116	Haze
2117	Sable Grey
2118	Dark Mineral **
2119	Dark Carbon ***
2120	Cranberry
2121	Deep Sea

* Armpad color available on Aeron® Chair, Graphite.
 ** Armpad color available on Aeron Chair, Mineral.
 *** Armpad color available on Aeron Chair, Carbon.

Textile Colors

continued

GSA

Price Category 10

Bristol Leather - Geiger Textile

Ancillary	
approx. 55 sq. ft. per hide	
100% leather	
5-507	Black
5-511	Putty
5-519	Hunter
5-520	White
5-521	Ivory
5-522	Parchment
5-537	Caribbean
5-546	Pumice
5-547	Smoke
5-548	Charcoal
5-549	Dark Shale
5-556	Downtown Grey
5-557	City Night
5-559	Ash Grey
5-563	Champagne
5-564	Chestnut Brown
5-565	Dark Sienna
5-566	Earthen
5-567	Desert
5-568	British Green
5-579	Paris Blue
5-583	Atlantic
5-592	Camel
5-594	Taupe
5-597	Pure
5-598	Cream
5-600	Midnight Blue
5-603	Sangria
5-604	Swiss Red
5-605	Nordic Yellow
5-606	Sky Grey
5-608	Natural

Firma – Maharam

Ancillary/Seating	
55" wide	
78% wool	
22% nylon	
3KH01/466582-001	Wrath
3KH02/466582-002	Pantomime
3KH03/466582-003	Shaded
3KH04/466582-004	Prologue
3KH05/466582-005	Framework
3KH06/466582-006	Railroad
3KH07/466582-007	Grommet
3KH08/466582-008	Lunisolar
3KH09/466582-009	Snowpack
3KH10/466582-010	Coldsnap
3KH11/466582-011	Sealift
3KH12/466582-012	Brood
3KH13/466582-013	Intertidal
3KH14/466582-014	Confide
3KH15/466582-015	Secluded
3KH16/466582-016	Leisure
3KH17/466582-017	Portfolio
3KH18/466582-018	Strato
3KH19/466582-019	Fogbow
3KH20/466582-020	Snowcone
3KH21/466582-021	Kazoo
3KH22/466582-022	Esteem
3KH23/466582-023	Mackerel
3KH24/466582-024	Brooch
3KH25/466582-025	Caesious
3KH26/466582-026	Islet
3KH27/466582-027	Biosphere
3KH28/466582-028	Hilltop
3KH29/466582-029	Arboreal
3KH30/466582-030	Lineage
3KH31/466582-031	Comfrey
3KH32/466582-032	Circe
3KH33/466582-033	Ecosystem
3KH34/466582-034	Knack
3KH35/466582-035	Watt
3KH36/466582-036	Epiphany
3KH37/466582-037	Gamma
3KH38/466582-038	Taxicab
3KH39/466582-039	Varietal

Gemma Multi – Maharam

Ancillary/Seating	
55" wide	
85% wool	
15% nylon	
ZGF01/466569-001	Andromeda
ZGF02/466569-002	Dappled
ZGF03/466569-003	Lyra
ZGF04/466569-004	Flaunt
ZGF05/466569-005	Celluloid
ZGF06/466569-006	Hydrozoa
ZGF07/466569-007	Firefly
ZGF08/466569-008	Pisces
ZGF09/466569-009	Strath
ZGF10/466569-010	Erosion
ZGF11/466569-011	Cabaret
ZGF12/466569-012	Candytuft
ZGF13/466569-013	Juice
ZGF14/466569-014	Fairground
ZGF15/466569-015	Copperplate
ZGF16/466569-016	Sunbird
ZGF17/466569-017	Cinematic
ZGF18/466569-018	Clairvoyant
ZGF19/466569-019	Crocus
ZGF20/466569-020	Memoir
ZGF21/466569-021	Roulette
ZGF22/466569-022	Voltaic
ZGF23/466569-023	Compote
ZGF24/466569-024	Lambent
ZGF25/466569-025	Twister
ZGF26/466569-026	Chronicle
ZGF27/466569-027	Sidereal
ZGF28/466569-028	Tanzanite
ZGF29/466569-029	Crystalize
ZGF30/466569-030	Chromium
ZGF31/466569-031	Pallium
ZGF32/466569-032	Spectre
ZGF33/466569-033	Courgette
ZGF34/466569-034	Viper
ZGF35/466569-035	Sunlit
ZGF36/466569-036	Heavenly
ZGF37/466569-037	Vernal
ZGF38/466569-038	Cress
ZGF39/466569-039	Limn
ZGF40/466569-040	Horseradish

Gemma Multi continued

ZGF41/466569-041	Shandy
ZGF42/466569-042	Granary
ZGF43/466569-043	Percolate
ZGF44/466569-044	Motor
ZGF45/466569-045	Unicorn
ZGF46/466569-046	Lobster
ZGF47/466569-047	Rhododendron
ZGF48/466569-048	Taffy
ZGF49/466569-049	Rishi
ZGF50/466569-050	Backcountry
ZGF51/466569-051	Buckthorn
ZGF52/466569-052	Coniferous
ZGF53/466569-053	Delphic
ZGF54/466569-054	Hieroglyph
ZGF55/466569-055	Eiderdown
ZGF56/466569-056	Sandbar
ZGF57/466569-057	Tanager

Gemma Multi Reverse – Maharam

Ancillary/Seating	
55" wide	
85% wool	
15% nylon	
ZGF58/466569-101	Andromeda Reverse
ZGF59/466569-102	Dappled Reverse
ZGF60/466569-103	Lyra Reverse
ZGF61/466569-104	Flaunt Reverse
ZGF62/466569-105	Celluloid Reverse
ZGF63/466569-106	Hydrozoa Reverse
ZGF64/466569-107	Firefly Reverse
ZGF65/466569-108	Pisces Reverse
ZGF66/466569-109	Strath Reverse
ZGF67/466569-110	Erosion Reverse

Price category 10 continued on next page

Textile Colors

continued

GSA

Price Category 10

continued

Price Category 11

Appendix: Textile Colors

Gemma Multi Reverse continued

ZGF68/466569-111 Cabaret	Reverse
ZGF69/466569-112 Candytuft	Reverse
ZGF70/466569-113 Juice	Reverse
ZGF71/466569-114 Fairground	Reverse
ZGF72/466569-115 Copperplate	Reverse
ZGF73/466569-116 Sunbird	Reverse
ZGF74/466569-117 Cinematic	Reverse
ZGF75/466569-118 Clairvoyant	Reverse
ZGF76/466569-119 Crocus	Reverse
ZGF77/466569-120 Memoir	Reverse
ZGF78/466569-121 Roulette	Reverse
ZGF79/466569-122 Voltaic	Reverse
ZGF80/466569-123 Compote	Reverse
ZGF81/466569-124 Lambent	Reverse
ZGF82/466569-125 Twister	Reverse
ZGF83/466569-126 Chronicle	Reverse
ZGF84/466569-127 Sidereal	Reverse
ZGF85/466569-128 Tanzanite	Reverse
ZGF86/466569-129 Crystalize	Reverse
ZGF87/466569-130 Chromium	Reverse
ZGF88/466569-131 Pallium	Reverse
ZGF89/466569-132 Spectre	Reverse

Gemma Multi Reverse continued

ZGF90/466569-133 Courgette	Reverse
ZGF91/466569-134 Viper	Reverse
ZGF92/466569-135 Sunlit	Reverse
ZGF93/466569-136 Heavenly	Reverse
ZGF94/466569-137 Vernal	Reverse
ZGF95/466569-138 Cress	Reverse
ZGF96/466569-139 Limn	Reverse
ZGF97/466569-140 Horseradish	Reverse
ZGF98/466569-141 Shandy	Reverse
ZGF99/466569-142 Granary	Reverse
ZGFA0/466569-143 Percolate	Reverse
ZGFA1/466569-144 Motor	Reverse
ZGFA2/466569-145 Unicorn	Reverse
ZGFA3/466569-146 Lobster	Reverse
ZGFA4/466569-147 Rhododendron	Reverse
ZGFA5/466569-148 Taffy	Reverse
ZGFA6/466569-149 Rishi	Reverse
ZGFA7/466569-150 Backcountry	Reverse
ZGFA8/466569-151 Buckthorn	Reverse
ZGFA9/466569-152 Coniferous	Reverse
ZGFB0/466569-153 Delphic	Reverse

Gemma Multi Reverse continued

ZGFB1/466569-154 Hieroglyph	Reverse
ZGFB2/466569-155 Eiderdown	Reverse
ZGFB3/466569-157 Tanager	Reverse

Petra - Maharam

Ancillary/Seating	
55" wide	
70% wool	
19% linen	
11% nylon	
ZP401/466580-001 Hieroglyph	
ZP402/466580-002 Interior	
ZP403/466580-003 Samovar	
ZP404/466580-004 Calcite	
ZP405/466580-005 Silversmith	
ZP406/466580-006 Rivet	
ZP407/466580-007 Carpolite	
ZP408/466580-008 Bonbon	
ZP409/466580-009 Dreamy	
ZP410/466580-010 Bejewel	
ZP411/466580-011 Sashimi	
ZP412/466580-012 Spirula	
ZP413/466580-013 Chalet	
ZP414/466580-014 Reindeer	
ZP415/466580-015 Nostalgia	
ZP416/466580-016 Trove	
ZP417/466580-017 Narcissus	
ZP418/466580-018 Yurt	
ZP419/466580-019 Congee	
ZP420/466580-020 Genepy	
ZP421/466580-021 Herbaceous	
ZP422/466580-022 Paddock	
ZP423/466580-023 Precious	
ZP424/466580-024 Biome	
ZP425/466580-025 Tinted	
ZP426/466580-026 Pelagic	
ZP427/466580-027 Bluebill	
ZP428/466580-028 Chicory	
ZP429/466580-029 Eaglet	
ZP430/466580-030 Permafrost	
ZP431/466580-031 Atlantic	
ZP432/466580-032 Airstream	
ZP433/466580-033 Debonair	

Prone Leather - Maharam

Ancillary	
approx. 50 sq. ft. per hide	
100% leather	
protective top coat	
1NX01/700020-001 Lotus	
1NX02/700020-002 Timbre	
1NX03/700020-003 Essence	
1NX04/700020-004 Script	
1NX05/700020-005 Gambit	
1NX06/700020-006 Obsidian	
1NX07/700020-007 Sail	
1NX09/700020-009 Vine	
1NX10/700020-010 Yarrow	
1NX13/700020-013 Balsa	
1NX14/700020-014 Shore	
1NX15/700020-015 Bricolage	
1NX17/700020-017 Ledge	
1NX19/700020-019 Mantra	
1NX20/700020-020 Java	
1NX21/700020-021 Lute	
1NX22/700020-022 Glow	
1NX23/700020-023 Hickory	

Textile Colors

continued

GSA

Price Category A

No fabrics available at this time.

Price Category B

Medium – Maharam

Ancillary/Seating/Workspaces
54" wide
100% polyester

VM01/463490-001 Raven
VM02/463490-002 Smoke
VM03/463490-003 Alloy
VM04/463490-004 Flax
VM07/463490-007 Espresso
VM14/463490-014 Laser
VM16/463490-016 Port
VM22/463490-022 Marina
VM29/463490-029 Pistachio
VM32/463490-032 Prospect
VM36/463490-036 Delight
VM39/463490-039 Nautical
VM40/463490-040 Pool
VM44/463490-044 Washed
VM45/463490-045 Sculpture
VM46/463490-046 Thatched
VM47/463490-047 Hike
VM48/463490-048 Tangle
VM49/463490-049 Pacific
VM50/463490-050 Cosmic
VM51/463490-051 Cascade
VM52/463490-052 Blackberry
VM53/463490-053 Nasturtium

Messenger — Maharam

Ancillary/Seating/Workspaces
54" wide
78% post-industrial
recycled polyester
15% polyester
7% nylon

TI07/458640-007 Shadow
TI08/458640-008 Bayou *
TI24/458640-024 Poppy
TI25/458640-025 Mao
TI29/458640-029 Onyx *
TI31/458640-031 Cloud *
TI38/458640-038 Depth *
TI40/458640-040 Nile *
TI41/458640-041 Azure *
TI45/458640-045 Cactus *
TI46/458640-046 Ice *
TI48/458640-048 Neon

Messenger continued

TI50/458640-050 Hydrangea
TI53/458640-053 Tangelo
TI54/458640-054 Lumine *
TI58/458640-058 Snow **
TI60/458640-060 Peridot
TI61/458640-061 Capri *
TI62/458640-062 Ultramarine
TI63/458640-063 Squall
TI66/458640-066 Cassis
TI67/458640-067 Aster
TI69/458640-069 Cherry
TI70/458640-070 Vibrant
TI71/458640-071 Satsuma *
TI72/458640-072 Maize
TI76/458640-076 Fossil
TI77/458640-077 Ash
TI78/458640-078 Tusk
TI79/458640-079 Oyster **
TI81/458640-081 Husk
TI84/458640-084 Robust
TI85/458640-085 Beyond
TI86/458640-086 Voyage *
TI87/458640-087 Everglade
TI89/458640-089 Blanch **
TI90/458640-090 Longspur
TI91/458640-091 Vireo
TI92/458640-092 Dipper
TI93/458640-093 Gale
TI94/458640-094 Hunter
TI95/458640-095 Lime
TI96/458640-096 Apple
TI97/458640-097 Krill
TI98/458640-098 Catalyst

* Colors available on
20-day lead time.
** Colors not available on Eames
Molded Fiberglass and Molded
Plastic Side Chairs.

Price Category C

Manner - Maharam

Ancillary/Seating/Workspaces
54" wide
65% post-industrial
recycled polyester
35% post-consumer
recycled polyester

Z2701/466177-001 Magic
Z2702/466177-002 Carob
Z2703/466177-003 Porpoise
Z2704/466177-004 Flint
Z2705/466177-005 Hush *
Z2706/466177-006 Nuance
Z2711/466177-011 Ember
Z2712/466177-012 Wagon
Z2713/466177-013 Ablaze
Z2714/466177-014 Peel
Z2716/466177-016 Butterscotch
Z2717/466177-017 Harvest
Z2720/466177-020 Parakeet
Z2722/466177-022 Aquatic
Z2723/466177-023 Cottage
Z2724/466177-024 Dahlia
Z2725/466177-025 Vivid
Z2726/466177-026 Basin
Z2727/466177-027 Schooner
Z2729/466177-029 Silverpoint
Z2730/466177-030 Lattice
Z2731/466177-031 Smoky
Z2732/466177-032 Magnetic
Z2733/466177-033 Woad
Z2734/466177-034 Resolute
Z2735/466177-035 Cruise
Z2736/466177-036 Atmospheric
Z2737/466177-037 Cloudburst
Z2738/466177-038 Tidewater
Z2739/466177-039 Firth
Z2740/466177-040 Oceanside
Z2741/466177-041 Grandeur
Z2742/466177-042 Comfort
Z2743/466177-043 Dill
Z2744/466177-044 Poplar
Z2745/466177-045 Citronella
Z2746/466177-046 Passerine

Price category C continued on
next page

Appendix: Textile Colors

Textile Colors

continued

GSA

Price Category C

continued

Manner continued

Z2747/466177-047	Southwest
Z2748/466177-048	Roseate
Z2749/466177-049	Charisma
Z2750/466177-050	Siltstone
Z2751/466177-051	Kimono
Z2752/466177-052	Valiant
Z2753/466177-053	Baroness

* Color not available on Eames Aluminum Group, Executive Chairs, Upholstered Molded Plywood Chairs, and Sofa Compact.

Merit - Maharam

Seating	
54" wide	
76% post-industrial recycled polyester	
24% polyester	
PFOA-Free stain resistant	
88Z01/466444-001	Trickle
88Z02/466444-002	Beluga
88Z03/466444-003	Gunmetal
88Z04/466444-004	Blackout
88Z05/466444-005	Superior
88Z06/466444-006	Ocean
88Z07/466444-007	Highborn
88Z08/466444-008	Immersed
88Z09/466444-009	Rainfall
88Z10/466444-010	Blizzard
88Z11/466444-011	Poolside
88Z12/466444-012	Steel
88Z13/466444-013	Zircon
88Z14/466444-014	Ripple
88Z15/466444-015	Aegean
88Z16/466444-016	Armada
88Z17/466444-017	Hedera
88Z18/466444-018	Rainforest
88Z19/466444-019	Gator
88Z20/466444-020	Vineyard
88Z21/466444-021	Pine
88Z22/466444-022	Kiwi
88Z23/466444-023	Kookaburra

Merit continued

88Z24/466444-024	Bellini
88Z25/466444-025	Sunflower
88Z26/466444-026	Sandstorm
88Z27/466444-027	Mudder
88Z28/466444-028	Lynx
88Z29/466444-029	Farro
88Z30/466444-030	Manila
88Z31/466444-031	Starfish
88Z32/466444-032	Brass
88Z33/466444-033	Arrow
88Z34/466444-034	Gelato
88Z35/466444-035	Nectarine
88Z36/466444-036	Macaron
88Z37/466444-037	Alert
88Z38/466444-038	Goji
88Z39/466444-039	Cabernet
88Z40/466444-040	Eggplant
88Z41/466444-041	Hawk
88Z42/466444-042	Stag
88Z43/466444-043	Overcast

Metric - Maharam

Seating/Workspaces	
54" wide	
51% post-industrial recycled polyester	
49% polyester	
Z302/466014-002	Fog
Z303/466014-003	Fleece
Z312/466014-012	Cardinal
Z313/466014-013	Lava
Z318/466014-018	Pollen
Z320/466014-020	Alligator
Z323/466014-023	Tar
Z324/466014-024	Anchor
Z326/466014-026	Admiral
Z327/466014-027	Seaport
Z328/466014-028	Scuba
Z329/466014-029	Skate
Z330/466014-030	Hopscotch
Z331/466014-031	Film
Z332/466014-032	Whale
Z333/466014-033	Downpour
Z334/466014-034	Midday

Metric continued

Z335/466014-035	Talisman
Z336/466014-036	Hedgerow
Z337/466014-037	Snorkel
Z338/466014-038	Highway
Z339/466014-039	Canary
Z340/466014-040	Sunny
Z341/466014-041	Aztec
Z342/466014-042	Fruit
Z343/466014-043	Galah
Z344/466014-044	Kiln
Z345/466014-045	Moth

Murmur - Maharam

Seating	
55" wide	
100% polyester	
PFOA-Free stain resistant	
8EY01/466446-001	Gust
8EY02/466446-002	Harmonica
8EY03/466446-003	Canopy
8EY04/466446-004	Dim
8EY05/466446-005	Peppercorn
8EY06/466446-006	Cauldron
8EY07/466446-007	Conquer
8EY08/466446-008	Rapids
8EY09/466446-009	Seawater
8EY10/466446-010	Baby
8EY11/466446-011	Elderberry
8EY12/466446-012	Iceberg
8EY13/466446-013	Tallgrass
8EY14/466446-014	Underground
8EY15/466446-015	Biome
8EY16/466446-016	Cask
8EY17/466446-017	Argan
8EY18/466446-018	Sundown
8EY19/466446-019	Ignite
8EY20/466446-020	Sultry
8EY21/466446-021	Sangria

Price Category D

Bluff - Maharam

Ancillary/Seating	
54" wide	
100% polyurethane	
Ink-resistant protective top coat	
Polyester backing	
8I801/466489-001	Loom
8I802/466489-002	Helm
8I803/466489-003	Cruller
8I804/466489-004	Folklore
8I805/466489-005	Beguile
8I806/466489-006	Sherpa
8I807/466489-007	Teleport
8I808/466489-008	Annex
8I809/466489-009	Lorimer
8I810/466489-010	Cinema
8I811/466489-011	Zip
8I812/466489-012	Coach
8I813/466489-013	Supernova
8I814/466489-014	Pirate
8I815/466489-015	Academy
8I816/466489-016	Disco
8I817/466489-017	Equator
8I818/466489-018	Brink
8I819/466489-019	Scene
8I820/466489-020	Petrichor
8I821/466489-021	Exotic
8I822/466489-022	Fauna
8I823/466489-023	Calabash
8I824/466489-024	Fuscous
8I825/466489-025	Wildling
8I826/466489-026	Blitz
8I827/466489-027	Allspice
8I828/466489-028	Lumos
8I829/466489-029	Pilot
8I830/466489-030	Jukebox
8I831/466489-031	Dugout
8I832/466489-032	Claret
8I833/466489-033	Flamenco

Price category D continued on next page

Appendix: Textile Colors

Textile Colors

continued

GSA

Price Category D

continued

Mode – Maharam	
Ancillary/Seating/Workspaces	
54” wide	
80% post-consumer recycled polyester	
20% polyester	
PFOA-Free stain resistant finish	
ZMD01/466337-001	Stroll
ZMD02/466337-002	Intaglio
ZMD03/466337-003	Ominous
ZMD04/466337-004	Machine
ZMD05/466337-005	Talus
ZMD06/466337-006	Marsh
ZMD07/466337-007	Hollow
ZMD08/466337-008	Sycamore
ZMD09/466337-009	Clavicle
ZMD10/466337-010	Billygoat
ZMD11/466337-011	Spindle
ZMD12/466337-012	Lemon
ZMD13/466337-013	Oxeye
ZMD14/466337-014	Henge
ZMD15/466337-015	Goldenrod
ZMD16/466337-016	Cottontail
ZMD17/466337-017	Lioness
ZMD18/466337-018	Oriole
ZMD19/466337-019	Rust
ZMD20/466337-020	Carotene
ZMD21/466337-021	Blush
ZMD22/466337-022	Vermillion
ZMD23/466337-023	Alder
ZMD24/466337-024	Kermes
ZMD25/466337-025	Barberry
ZMD26/466337-026	Petal
ZMD27/466337-027	Valley
ZMD28/466337-028	Odyssey
ZMD29/466337-029	Ballpoint
ZMD30/466337-030	Toile
ZMD31/466337-031	Paradise

Mode continued	
ZMD32/466337-032	Angelfish
ZMD33/466337-033	Denim
ZMD34/466337-034	Crush
ZMD35/466337-035	Jetty
ZMD36/466337-036	Saltwater
ZMD37/466337-037	Mallard
ZMD38/466337-038	Celtic
ZMD39/466337-039	Eucalyptus
ZMD40/466337-040	Bonsai
ZMD41/466337-041	Sassafras
ZMD42/466337-042	Yucca
ZMD43/466337-043	Lichen

Spiral - Maharam	
Workspaces	
66” wide	
100% polyester	
ZS301/901882-001	Chalk
ZS303/901882-003	Wheat
ZS304/901882-004	Mica
ZS305/901882-005	Pavement
ZS306/901882-006	Graphite

Price Category E

Article – Maharam	
Ancillary/Seating	
54” wide	
100% vinyl	
ZAT08/458600-008	Marina
ZAT13/458600-013	Flume
ZAT14/458600-014	Storm
ZAT15/458600-015	Toast
ZAT19/458600-019	Fleece
ZAT22/458600-022	Stone
ZAT26/458600-026	Mercury
ZAT29/458600-029	Bluegrass
ZAT31/458600-031	Truffle
ZAT32/458600-032	Gravel
ZAT33/458600-033	Value
ZAT34/458600-034	Tint
ZAT35/458600-035	Snowflake
ZAT36/458600-036	Chalice
ZAT37/458600-037	Trail
ZAT38/458600-038	Pyramid
ZAT39/458600-039	Desert
ZAT40/458600-040	Lei
ZAT41/458600-041	Rouge
ZAT42/458600-042	Karma
ZAT43/458600-043	Opal
ZAT44/458600-044	Periwinkle
ZAT45/458600-045	Vampire
ZAT46/458600-046	Surf
ZAT47/458600-047	Plumage

Micro – Maharam	
Ancillary	
54” wide	
100% vinyl	
ZMB01/466099-001	Muslin
ZMB04/466099-004	Basalt
ZMB06/466099-006	Phantom
ZMB07/466099-007	Depth
ZMB08/466099-008	Cottage
ZMB09/466099-009	Hunter
ZMB11/466099-011	Tomatillo
ZMB12/466099-012	Brew
ZMB14/466099-014	Tang
ZMB15/466099-015	Risk

Parallel – Maharam	
Workspaces	
66” wide	
100% recycled polyester	
TT03/901180-003	Fog
TT22/901180-022	Sterling
TT23/901180-023	Linen
TT24/901180-024	Pea
TT27/901180-027	Boulder
TT28/901180-028	Stream
TT29/901180-029	Shiitake
TT32/901180-032	Brandy
TT33/901180-033	Crater
TT36/901180-036	Quail

Appendix: Textile Colors

Textile Colors

continued

GSA

Price Category F

Appendix: Textile Colors

Apt – Maharam

Ancillary/Seating 54" wide 100% polyurethane/silicone Ink-resistant protective top coat Polyester backing
82T12/466392-012 Iris
82T13/466392-013 Nocturnal
82T14/466392-014 Fluid
82T15/466392-015 Eden
82T16/466392-016 Galactic
82T17/466392-017 Shoreline
82T18/466392-018 Jade
82T19/466392-019 Garden
82T20/466392-020 Botanic
82T21/466392-021 Chartreuse
82T23/466392-023 Lyric
82T24/466392-024 Turmeric
82T25/466392-025 Bengal
82T26/466392-026 Core
82T27/466392-027 Mantle
82T28/466392-028 Sorbet
82T32/466392-032 Oak
82T33/466392-033 Castle
82T34/466392-034 Follow
82T35/466392-035 Elixir
82T36/466392-036 Charm
82T37/466392-037 Descend
82T38/466392-009 Sketch
82T39/466392-010 Glacier
82T40/466392-031 Fortress
82T41/466392-030 Lotus
82T42/466392-001 Coconut
82T43/466392-011 Cobblestone
82T44/466392-029 Bloom
82T45/466392-022 Crepe
82T46/466392-006 Hickory
82T47/466392-007 Constellation
82T48/466392-008 Labyrinth
82T49/466392-002 Vibe
82T50/466392-003 Stampede
82T51/466392-004 Lumber
82T52/466392-005 Gingerbread

Emit – Maharam

Workspaces 54" wide 55% post-industrial recycled polyester 45% post-consumer recycled polyester PFOA-free stain resistant
8EX01/466378-001 Wed
8EX02/466378-002 Zebra
8EX03/466378-003 Chiffon
8EX05/466378-005 Nectar
8EX06/466378-006 Elk
8EX08/466378-008 Goldenrod
8EX09/466378-009 Beached
8EX10/466378-010 Samba
8EX11/466378-011 Nest
8EX14/466378-014 Groove
8EX17/466378-017 Haiku
8EX18/466378-018 Bluefin
8EX19/466378-019 Flow
8EX20/466378-020 Xenon
8EX21/466378-021 Artem
8EX22/466378-022 Zen
8EX25/466378-025 Limeade

Instill – Maharam

Ancillary/Seating 54" wide 100% polyurethane Ink-resistant protective top coat Polyester backing
74M01/466351-001 Page
74M02/466351-002 Limestone
74M03/466351-003 Bobwhite
74M04/466351-004 Loafer
74M07/466351-007 Shaker
74M08/466351-008 Doe
74M09/466351-009 Ride
74M10/466351-010 Squire
74M11/466351-011 Tannin
74M12/466351-012 Vitis
74M14/466351-014 Quail
74M15/466351-015 Brittanica
74M16/466351-016 Narwhal
74M18/466351-018 Stowaway
74M19/466351-019 Koala
74M20/466351-020 Dorsal
74M21/466351-021 Stealth

Keen - Maharam

Seating 54" wide 61% polyester 39% polyolefin PFOA-Free stain resistant Acrylic backing
89N01/466433-001 Gaur
89N02/466433-002 Lock
89N03/466433-003 Elk
89N04/466433-004 Oatmeal
89N05/466433-005 Lakefront
89N06/466433-006 Argent
89N07/466433-007 Coyote
89N08/466433-008 Eventide
89N09/466433-009 Canal
89N10/466433-010 Rosemary
89N11/466433-011 Herb
89N12/466433-012 Ruby
89N13/466433-013 Loganberry

Ledger – Maharam

Ancillary/Seating 54" wide 100% polyurethane
V9G1/463770-001 001
V9G2/463770-002 002
V9G3/463770-003 003
V9G4/463770-004 004
V9GG/463770-017 017
V9GQ/463770-025 025
V9GS/463770-026 026
V9GU/463770-028 028
V9GV/463770-029 029
V9GW/463770-030 030
V9GX/463770-031 031
V9GY/463770-032 032
V9G18/463770-042 042
V9G19/463770-043 043
V9G20/463770-044 044
V9G21/463770-045 045
V9G22/463770-046 046

Loop - Maharam

Seating 57" wide 48% post-industrial recycled polyester 26% polyester 26% post-consumer recycled polyester PFOA-Free stain resistant Acrylic Backing
ZLL01/466469-001 Opossum
ZLL02/466469-002 Foundation
ZLL03/466469-003 Naval
ZLL04/466469-004 Buoyant
ZLL05/466469-005 Mockingbird
ZLL06/466469-006 Dynasty
ZLL07/466469-007 Zori
ZLL08/466469-008 Wildfire
ZLL09/466469-009 Floral
ZLL10/466469-010 Penguin

Price category F continued on next page

Textile Colors

continued

GSA

Price Category F

continued

Pitch - Maharam	
Ancillary	
54" wide	
100% vinyl	
ZPC04/466186-004	Pollen
ZPC07/466186-007	Apple
ZPC11/466186-011	Voyage
ZPC12/466186-012	Turquoise
ZPC14/466186-014	Inlet
ZPC15/466186-015	Captain
ZPC16/466186-016	Aura
ZPC17/466186-017	Coastal
ZPC18/466186-018	Fog
ZPC19/466186-019	Coal
ZPC21/466186-021	Mulberry
ZPC24/466186-024	Flame
ZPC26/466186-026	Tumbleweed
ZPC29/466186-029	Subtle
ZPC30/466186-030	Buff

Pepper - Maharam	
Seating	
58" wide	
49% polyester	
41% post-industrial recycled polyester	
10% post-consumer recycled polyester	
PFOA-Free stain resistant	
Acrylic Backing	
8LW01/466486-001	Dojo
8LW02/466486-002	Marengo
8LW03/466486-003	Harlequin
8LW04/466486-004	Pavlova
8LW06/466486-006	Achiote
8LW07/466486-007	Essence
8LW08/466486-008	Genome
8LW09/466486-009	Myriad
8LW10/466486-010	Terrarium

Scuba - Maharam	
Ancillary	
54" wide	
100% polyurethane	
V9B1/464930-001	Vanilla
V9B5/464930-005	Chinchilla
V9B6/464930-006	Mahogany
V9B7/464930-007	Jet
V9B8/464930-008	Charcoal
V9B9/464930-009	Dolphin
V9BA/464930-010	Drizzle
V9BC/464930-012	Conifer
V9BD/464930-013	Bottle
V9BF/464930-015	Tourmaline
V9BG/464930-016	Sapphire
V9BH/464930-017	Electric
V9BL/464930-020	Cabernet
V9BM/464930-021	Brick
V9BN/464930-022	Coral
V9BP/464930-023	Autumn

Strum - Maharam	
Seating	
54" wide	
100% polyurethane	
with silver-based antimicrobial	
Z3301/466122-001	Overcast
Z3302/466122-002	Ridge
Z3304/466122-004	Pigeon
Z3307/466122-007	Bur
Z3308/466122-008	Abalone
Z3312/466122-012	Lemongrass

Price Category G

Compound - Maharam	
Seating	
54" wide	
100% polyurethane	
silane-based antimicrobial	
ZC201/466196-001	Quartz
ZC203/466196-003	Weathered
ZC204/466196-004	Cliff
ZC205/466196-005	Espresso
ZC206/466196-006	Smolder
ZC207/466196-007	Blaze
ZC208/466196-008	Mandarin
ZC209/466196-009	Maple
ZC210/466196-010	Perennial
ZC211/466196-011	Mountainside
ZC212/466196-012	Tundra
ZC213/466196-013	Manatee
ZC214/466196-014	Marine
ZC215/466196-015	Twilight
ZC216/466196-016	Shelter
ZC217/466196-017	Vessel
ZC218/466196-018	Smoke
ZC219/466196-019	Fog

Gild - Maharam	
Ancillary/Seating	
54" wide	
100% non-phthalate vinyl	
Ink-resistant protective top coat	
Polyester backing	
8AR01/466432-005	Grapevine
8AR02/466432-009	Frosting
8AR03/466432-007	Smokey
8AR04/466432-003	Skylight
8AR05/466432-011	Sandstone
8AR06/466432-004	Hurricane
8AR07/466432-002	Wreath
8AR08/466432-001	Rainforest
8AR09/466432-012	Fudge
8AR10/466432-010	Lantern
8AR11/466432-006	Planet
8AR12/466432-008	Reflection

Sudden - Maharam	
Ancillary	
54" wide	
100% polyurethane	
ZSD02/463000-002	002
ZSD03/463000-003	003
ZSD05/463000-005	005
ZSD06/463000-006	006
ZSD07/463000-007	007
ZSD08/463000-008	008
ZSD09/463000-009	009
ZSD10/463000-010	010
ZSD11/463000-011	011
ZSD13/463000-013	013
ZSD15/463000-015	015
ZSD16/463000-016	016
ZSD17/463000-017	017
ZSD18/463000-018	018
ZSD19/463000-019	019
ZSD20/463000-020	020
ZSD24/463000-024	024
ZSD27/463000-027	027
ZSD36/463000-036	036

Appendix: Textile Colors

Textile Colors

continued

GSA

Appendix: Textile Colors

Price Category H

Circles – Maharam	
Ancillary/Seating	
55" wide	
70% cotton	
30% polyester	
ZT01/458310-001	Khaki
ZT02/458310-002	Fatigue
ZT03/458310-003	Document
ZT04/458310-004	Engine

Dot Pattern – Maharam	
Ancillary/Seating	
55" wide	
71% cotton	
29% polyester	
ZK01/458300-001	Document
ZK02/458300-002	Taupe
ZK04/458300-004	Red
ZK05/458300-005	Navy

Regatta – Maharam	
Ancillary	
54" wide	
65% solution-dyed acrylic	
35% solution-dyed polyester	
ZRT01/466189-001	Drift
ZRT02/466189-002	Parasol
ZRT04/466189-004	Swell

Small Dot Pattern – Maharam	
Ancillary/Seating	
55" wide	
71% cotton	
29% polyester	
ZL01/458320-001	Document
ZL02/458320-002	Sand
ZL03/458320-003	Khaki
ZL04/458320-004	Taupe
ZL05/458320-005	Charcoal
ZL06/458320-006	Document Reverse
ZL07/458320-007	Red
ZL08/458320-008	Yellow
ZL09/458320-009	Green

Price Category I

Cursive – Maharam	
Seating	
54" wide	
67% solution-dyed acrylic	
33% solution-dyed polyester	
PFOA-Free stain resistant	
7CW01/466335-001	Fast
7CW03/466335-003	Beachcomb
7CW05/466335-005	Swift
7CW06/466335-006	Jetstream
7CW07/466335-007	Inkwell
7CW08/466335-008	Rubber

Price Category J-O

No fabrics available at this time.

Price Category P

Layers Garden – Maharam	
Ancillary	
52" wide	
96% wool	
3% nylon	
1% polyester	
ZLY01/465916-001	Ivy/Bronze
ZLY02/465916-002	Putty/ Turquoise
ZLY03/465916-003	Pewter/ White
ZLY04/465916-004	Chocolate/ Lilac
ZLY05/465916-005	Peat/Copper

Textile Colors

continued

GSA

Price Category Q

Brushed Camel – Maharam

Ancillary

58" wide

100% baby camel hair

ZBA01/465977-001 Albino

ZBA02/465977-002 Natural

Price Category R-S

No fabrics available at this time.

Price Category T

All Grain Leather – Edelman

Ancillary

approx. 50 sq. ft. per hide

100% full-grain Aniline-dye cowhide

VB01/AG01 Pitch Brown

VB02/AG02 White

VB03/AG03 Cloud

VB04/AG04 Shadow

VB05/AG05 Black

VB06/AG06 Baked Bean

VB07/AG07 Mildew

VB08/AG08 Soot

VB09/AG09 Blue Jeans

VB10/AG10 Merlot

VB11/AG11 Nutmeg

VB12/AG12 Butter

VB13/AG13 Cherry

VB14/AG14 Burnt Orange

VB15/AG15 Whiskey

VB17/AG17 Raw Silk

VB18/AG18 Balsa

VB19/AG19 Naturale

VB21/AG21 Greige

VB22/AG27 Latte

VB23/AG28 Coral

VB24/AG29 Rose

VB25/AG30 Zinnia

VB26/AG31 Iris

VB27/AG32 Daffodil

Price Category U-Z

No fabrics available at this time.

Textile Colors

continued

GSA

Price Category 10M

Appendix: Textile Colors

Pace Leather – Maharam

Ancillary

approx. 50 sq. ft. per hide

100% leather

ZPA01/700011-001	Whisper
ZPA02/700011-002	Shy
ZPA03/700011-003	Granite
ZPA04/700011-004	Misty
ZPA05/700011-005	Studio
ZPA06/700011-006	Throne
ZPA07/700011-007	Proper
ZPA08/700011-008	Huron
ZPA09/700011-009	Darkroom
ZPA10/700011-010	Bark
ZPA11/700011-011	Raspberry
ZPA12/700011-012	Sangria
ZPA13/700011-013	Admiral
ZPA14/700011-014	Juniper
ZPA15/700011-015	Regal
ZPA16/700011-016	Vapor
ZPA17/700011-017	Valley
ZPA18/700011-018	Bushel
ZPA19/700011-019	Heirloom
ZPA20/700011-020	Palomino
ZPA21/700011-021	Bamboo
ZPA22/700011-022	Saffron
ZPA23/700011-023	Tearose
ZPA24/700011-024	Canyon
ZPA25/700011-025	Bistro
ZPA26/700011-026	Toffee
ZPA27/700011-027	Rodeo
ZPA28/700011-028	Mudslide
ZPA29/700011-029	Greige
ZPA30/700011-030	Reflection
ZPA31/700011-031	Pure
ZPA32/700011-032	Desert
ZPA33/700011-033	Griffin
ZPA34/700011-034	Urbane
ZPA35/700011-035	Woodrose

For more information about our products and services or to see a list of dealers, please visit us at HermanMiller.com or call (800) 851 1196.

© 2024 Herman Miller, Inc., Zeeland, Michigan

Distribution Rights

Working together since 1956, Herman Miller and Vitra are the authentic sources of designs by Charles and Ray Eames, Alexander Girard, and George Nelson. All the designs shown in this book are protected by law. Herman Miller has obtained all rights to make and sell these designs. Also, Herman Miller holds exclusive worldwide manufacturing and distribution rights for these products with the following exceptions:

Charles and Ray Eames, George Nelson, and Alexander Girard—Worldwide distribution rights for furniture in all areas except Europe and the Middle East. For those areas, please contact Vitra.

Isamu Noguchi—Worldwide distribution rights for the Noguchi Rudder Table. Distribution rights for the Noguchi Table in North America and Central America only. For all other areas, please contact Vitra.

Magis—Exclusive distribution rights in the US and Canada. For all other areas, please contact Magis.

© **HermanMiller**, , Action Office, Aeron, Aside, Canvas Office Landscape, Caper, Cosm, Co/Struc, Eames, Embody, Ethospace, Exclave, Fine-Tune, FlexFront, Formcoat, Ground Cloth, Intent, Layout Studio, Lino, Maharam, Meridian, Mirra, Motia, Nelson, Pellicle, Perspectives, Plex, PostureFit, PostureFit SL, Sayl, Setu, Tu, Verus, Y-Tower and Zeph are among the registered trademarks of Herman Miller, Inc., and its owned subsidiaries.

™ AireWeave, Bubbletack, Canvas Vista, Cellular Suspension, Commend, Compass, Connect, DOT, Durawrap, Everywhere, Flex-Edge, Headway, Hopsak 2, Iota, Keyless Entry, Latitude, Lyris 2, Mora, Multiscrim, Nevi, OE1, OE1 Workspace Collection, Overlay, Renew, Stackable, Swoop, Thrive, TriFlex, Twist and Valor are among the trademarks of Herman Miller, Inc., and its owned subsidiaries.

Chemsurf® is a registered trademark of Wilsonart International.

Corian® is a registered trademark of E.I. du Pont de Nemours and Company Corporation.

FLEXNET™ is a trademark of Milliken & Company.

Floor Saver Glide® is a registered trademark of Carpin Manufacturing, Inc.

Forest Stewardship Council® is a registered trademark of the Forest Stewardship Council A.C. (FSC). We are FSC® certified (FSC® C102895).

FSC® is a registered trademark of the Forest Stewardship Council A.C. (FSC).

MicrobeCare™ is a trademark of Parasol Medical LLC.

Microsoft® and Natural® Keyboard are registered trademarks of Microsoft Corporation.

Place Textiles® is a registered trademark of Place Textiles.