

Classic Seating

Prices effective February 5, 2007
Published January 2008

Introduction	2
Eames® Aluminum Group Chairs	3
Executive Chair	5
Management Chair	6
Side Chair	7
Lounge Chair and Ottoman	8
Eames Soft Pad Group Chairs	11
Executive Chair	13
Management Chair	14
Side Chair	15
Lounge Chair and Ottoman	16
Eames Executive Work Chair	19
Eames Tandem Sling Seating	23
Eames Classic Seating	31
Lounge Seating	33
Sofas	37
Molded Plywood Chairs	39
Molded Plastic Chairs	43
Wire Chair	46
Nelson™ Swag Leg Group	47
Nelson Classic Seating	51
Coconut Chair	53
Platform Bench	54
Marshmallow Sofa	55
Goetz™ Sofa	57
Capelli Stool	61
Indices	65
By Name	65
By Number	67

Appendices

To view and/or print price book appendices, go to www.HermanMiller.com, select "All products," then "Pricing information," and choose a product category.



Introduction

A Note on the Organization of This Book

There are a few signals that will help you understand the organization of this book. Once you know them, you should be able to find your way around easily.

Like a newspaper, this book is formatted with columns of text and illustrations that run vertically.

Information wraps from one column to the next and continues for as many pages as it needs to.

Black bars are clues.

A black bar at the top of a page signals the start of information about a product.

This information is divided into two sections, each signaled by a black bar. Product Information includes a description, additional notes, and dimensional drawings. Specification Information, which always begins at the top of a column, includes a series of steps. Each step represents a decision you need to make in order to complete your product number. Steps must be followed sequentially. The number of pages needed to complete information on a product varies; some will be complete in one page; others may fill three or four pages. Just continue going through the steps until you run into the next product, signaled by the black bar at the top of the page.

Black tabs running along the outside edge of the page help you locate what section you are in or what section you want to go to. You can thumb forwards or backwards to find a section; tabs and text appear on both sides of the page.

The additional pages in the back of the book include the appendices and indices. They are signaled by a long black bar running along the outside edge of the page.

The index is presented two ways.

The first index is in alphabetical order by product name. It can be helpful if you are new to the products and numbering scheme or if you are looking for a type of product, such as work chair or round table.

The second index is by product number. It lists, in alphanumeric order, the base product number, typically a five-digit number.

General Information

This book is effective February 5, 2007, subject to change without notice. Products may be purchased from authorized Herman Miller dealers who will quote prices upon request. For more information about our products and services or to see a list of dealers, visit www.HermanMiller.com.

All prices are list prices. Additional services, such as planning services, design, storage, and installation, are not included and must be added to these prices when the additional services are requested.

Illustrations, specifications, and prices are based on the latest information at the time of publication. The right is reserved to make changes at any time without notice in prices, fabrics, finishes, materials, specifications, and models, and also to discontinue models and finishes.

Dimensions shown in the drawings are engineering drawing dimensions rounded up to the nearest $\frac{1}{8}$ ". Product is shipped set up or knocked down. Products that include "Shipped knocked down" in the description require some assembly. If this statement does not appear in the description, the product is shipped assembled.

Service problems are normally handled by a Herman Miller authorized dealer. Where this cannot be accomplished on a local level, service problems should be referred to the Customer Care Representative for your region, Herman Miller, Inc., Zeeland, Michigan 49464.

20-Day or Less/Assigned Lead-Time Shipments

All products and options in this price book not designated by an Assigned Program icon  will ship in **20 business days or less** after being acknowledged by Herman Miller.

Products and options designated by an  are on the assigned lead-time program and may ship in 20 days, less than 20 days, or more than 20 days from order acknowledgement.

Executive Chair

Management Chair

Side Chair

Lounge Chair and Ottoman



Executive Chair

EA337

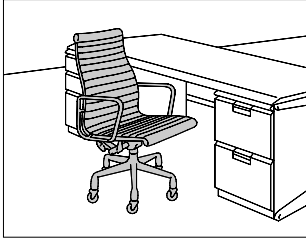

Product Information

Description

This high-back chair with arms has a lightweight aluminum frame with suspended upholstery. It has a 5-star base with casters, tilt-swivel mechanism, and seat-height adjustment.

Notes

Chair is tested and warranted for use by persons 300 pounds and under. For description of casters, see Casters and Glides in Appendices. Customer's Own Material (COM) requires 1½ yards. Customer's Own Leather (COL) requires 45 square feet. See Order Information in Appendices.

Dimensions

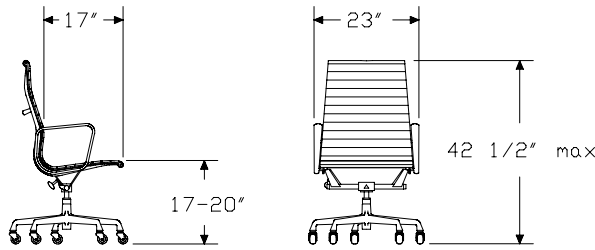

Specification Information

Step 1.

EA337 A \$1480

Step 2. Casters

CA 2" single wheel caster, hard floors or carpet A +\$0
UD 2" hard double wheel caster, carpet, black painted A +\$0
VD 2" hard double wheel caster, carpet, chrome A +\$0

Step 3. Base/Frame Finish

L polished aluminum A +\$0

Step 4. Fabric

See application chart and textiles list for fabric usage and numbers. First 2 digits of number indicate fabric line; remaining digit(s) indicate fabric color.

Price Category 1	+\$0
Price Category 2	+\$45
Price Category 3	+\$102
Price Category 4	+\$147
Price Category 5	+\$186
Price Category 6	+\$225
Price Category 7	+\$240
Price Category 8	+\$436
Price Category 9	+\$621
Price Category B	+\$46
Price Category E	+\$115
Price Category H	+\$276
Price Category R	+\$1105
Price Category V	+\$2028

Eames® Aluminum Group Executive Chair

Management Chair

EA334
EA335

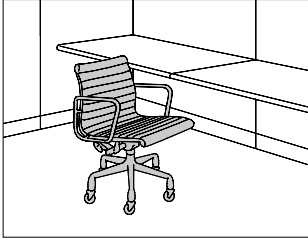

Eames® Aluminum Group Management Chair

Product Information

Description
This low-back chair with arms has a lightweight aluminum frame with suspended upholstery. It has a 5-star base, tilt-swivel mechanism, and seat-height adjustment. The chair is available with casters or glides. The chair with glides includes 1/2" (GD) glides for hard floors or carpet.

Notes
Chair is tested and warranted for use by persons 300 pounds and under. For description of casters and glides, see Casters and Glides in Appendices.
Customer's Own Material (COM) requires 1 1/3 yards. Customer's Own Leather (COL) requires 45 square feet. See Order Information in Appendices.

Dimensions

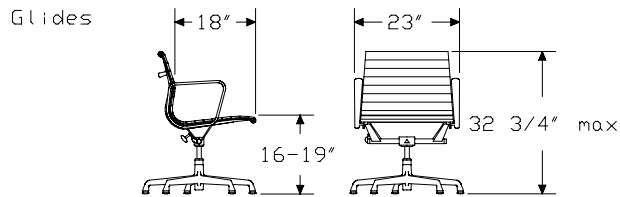
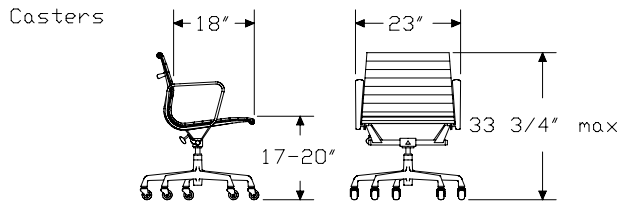

Specification Information

Step 1.

EA33 A

Step 2. Casters/Glides

- 5** casters A
- 4** glides A

Prices for Steps 1-2.

EA335	\$1354
EA334	\$1354

Step 3. Casters

- For casters (5)*
- CA** 2" single wheel caster, hard floors or carpet A +\$0
 - UD** 2" hard double wheel caster, carpet, black painted A +\$0
 - VD** 2" hard double wheel caster, carpet, chrome A +\$0

Step 4. Base/Frame Finish

- L** polished aluminum A +\$0

Step 5. Fabric

See application chart and textiles list for fabric usage and numbers. First 2 digits of number indicate fabric line; remaining digit(s) indicate fabric color.

Price Category 1	+\$0
Price Category 2	+\$39
Price Category 3	+\$73
Price Category 4	+\$113
Price Category 5	+\$140
Price Category 6	+\$169
Price Category 7	+\$180
Price Category 8	+\$404
Price Category 9	+\$591
Price Category B	+\$31
Price Category E	+\$77
Price Category H	+\$184
Price Category R	+\$1072
Price Category V	+\$2028

Side Chair

EA330
EA331

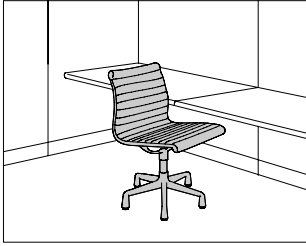

Product Information

Description

This low-back chair has a lightweight aluminum frame with suspended upholstery. It has a 5-star base with 1/2" (GD) glides for hard floors or carpet, swivel mechanism, and fixed seat height.

Notes

Chair is tested and warranted for use by persons 300 pounds and under. For description of glide, see Casters and Glides in Appendices. Customer's Own Material (COM) requires 1 1/3 yards. Customer's Own Leather (COL) requires 45 square feet. See Order Information in Appendices.

Dimensions

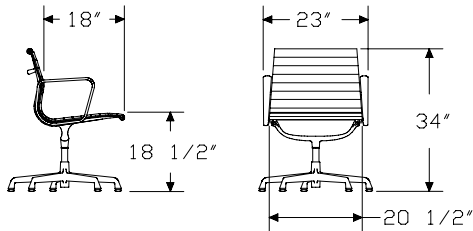

Specification Information

Step 1.

EA33

Step 2. Arms

0 no arms
1 arms A

Prices for Steps 1-2.

EA330	\$1018
EA331	\$1338

Step 3. Base/Frame Finish

L polished aluminum + \$0

Step 4. Fabric

See application chart and textiles list for fabric usage and numbers. First 2 digits of number indicate fabric line; remaining digit(s) indicate fabric color.

Price Category 1	+ \$0
Price Category 2	+ \$39
Price Category 3	+ \$73
Price Category 4	+ \$113
Price Category 5	+ \$140
Price Category 6	+ \$169
Price Category 7	+ \$180
Price Category 8	+ \$404
Price Category 9	+ \$591
Price Category B	+ \$31
Price Category E	+ \$77
Price Category H	+ \$184
Price Category R	+ \$1072
Price Category V	+ \$2028

Fame's® Aluminum Group Side Chair

Lounge Chair

EA333
EA338



Product Information

Description

This high-back chair has a lightweight aluminum frame with suspended upholstery. It has a 5-star base with 1/2" (GD) glides for hard floors or carpet and fixed seat height.

The tilt-swivel chair includes a headrest upholstered in the specified leather, fabric, or vinyl color.

Notes

Chair is tested and warranted for use by persons 300 pounds and under. For description of glides, see Casters and Glides in Appendices.

Customer's Own Material (COM) requires 1 3/4 yards for swivel chair and 3 yards for tilt-swivel chair. Customer's Own Leather (COL) requires 50 square feet for swivel chair and 55 square feet for tilt-swivel chair. See Order Information in Appendices.

Dimensions

Swivel

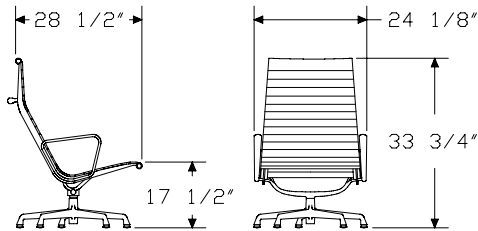

Tilt Swivel

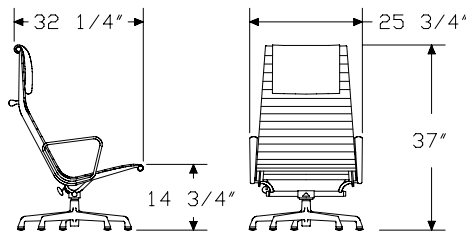

Specification Information

Step 1.

EA33

Step 2. Tilt/Arms

- 3** swivel and arms
- 8** tilt swivel, arms, and headrest

Prices for Steps 1-2.

EA333	\$1557
EA338	\$1686

Step 3. Base/Frame Finish

L polished aluminum	+\$0
----------------------------	------

Step 4. Fabric

See application chart and textiles list for fabric usage and numbers. First 2 digits of number indicate fabric line; remaining digit(s) indicate fabric color.

Price Category 1	+\$0
Price Category 2	+\$45
Price Category 3	+\$102
Price Category 4	+\$147
Price Category 5	+\$186
Price Category 6	+\$225
Price Category 7	+\$240
Price Category 8	+\$436
Price Category 9	+\$621
Price Category B	+\$46
Price Category E	+\$115
Price Category H	+\$276
Price Category R	+\$1105
Price Category V	+\$2028

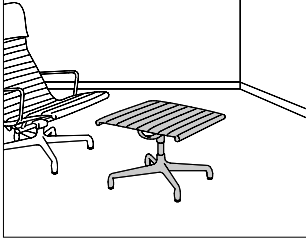

Product Information

Description

This upholstered ottoman has a lightweight aluminum frame and 1/2" (GD) glides for hard floors or carpet.

Notes

For description of glides, see Casters and Glides in Appendices.
 Customer's Own Material (COM) requires 1 yard. Customer's Own Leather (COL) requires 20 square feet. See Order Information in Appendices.

Dimensions

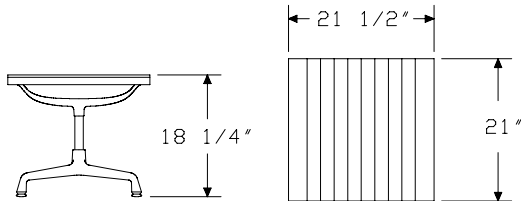

Specification Information

Step 1.

EA323 \$744

Step 2. Base/Frame Finish

L polished aluminum +\$0

Step 3. Fabric

See application chart and textiles list for fabric usage and numbers. First 2 digits of number indicate fabric line; remaining digit(s) indicate fabric color.

Price Category 1	+\$0
Price Category 2	+\$23
Price Category 3	+\$45
Price Category 4	+\$68
Price Category 5	+\$85
Price Category 6	+\$102
Price Category 7	+\$109
Price Category 8	+\$205
Price Category 9	+\$281
Price Category B	+\$23
Price Category E	+\$58
Price Category H	+\$138
Price Category R	+\$539
Price Category V	+\$1828

Fame's® Aluminum Group Lounge Chair and Ottoman

Executive Chair

Management Chair

Side Chair

Lounge Chair and Ottoman

Executive Chair

EA437

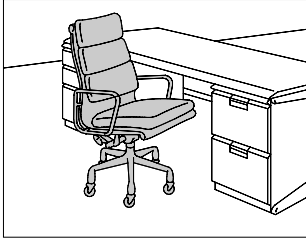

Product Information

Description

This high-back chair with arms has a lightweight aluminum frame and 2"-thick upholstered foam cushions. It has a 5-star base with casters, tilt-swivel mechanism, and seat-height adjustment.

Notes

Chair is tested and warranted for use by persons 300 pounds and under. For description of casters, see Casters and Glides in Appendices. Customer's Own Material (COM) requires 3 yards. Customer's Own Leather (COL) requires 56 square feet. See Order Information in Appendices.

Dimensions

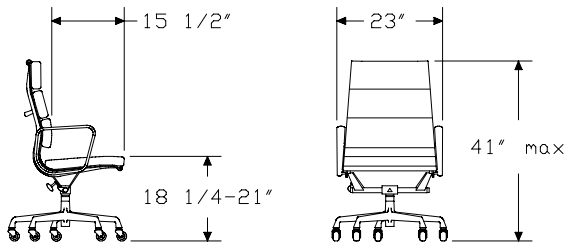

Specification Information

Step 1.

EA437 A \$2558

Step 2. Casters

CA	2" single wheel caster, hard floors or carpet	A	+\$0
UD	2" hard double wheel caster, carpet, black painted	A	+\$0
VD	2" hard double wheel caster, carpet, chrome	A	+\$0

Step 3. Base/Frame Finish

L	polished aluminum	A	+\$0
----------	-------------------	---	------

Step 4. Fabric

See application chart and textiles list for fabric usage and numbers. First 2 digits of number indicate fabric line; remaining digit(s) indicate fabric color.

Price Category 1	+\$0
Price Category 2	+\$57
Price Category 3	+\$135
Price Category 4	+\$216
Price Category 5	+\$271
Price Category 6	+\$327
Price Category 7	+\$349
Price Category 8	+\$450
Price Category B	+\$81
Price Category E	+\$201
Price Category F	+\$241
Price Category G	+\$362
Price Category H	+\$482
Price Category R	+\$1748
Price Category V	+\$2028

Eames® Soft Pad Group Executive Chair

Management Chair

EA434
EA435

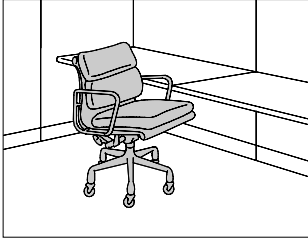

Eames® Soft Pad Group Management Chair

Product Information

Description
This low-back chair with arms has a lightweight aluminum frame and 2"-thick upholstered foam cushions. It has a 5-star base, tilt-swivel mechanism, and seat-height adjustment. The chair is available with casters or glides. The chair with glides includes 1/2" (GD) glides for hard floors or carpet.

Notes
Chair is tested and warranted for use by persons 300 pounds and under. For description of casters and glides, see Casters and Glides in Appendices.
Customer's Own Material (COM) requires 2 1/2 yards. Customer's Own Leather (COL) requires 45 square feet. See Order Information in Appendices.

Dimensions

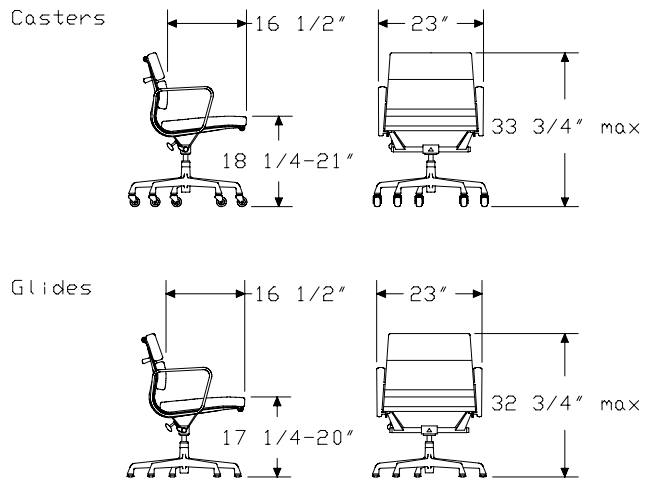

Specification Information

Step 1.

EA43 A

Step 2. Casters/Glides

- 5** casters A
- 4** glides A

Prices for Steps 1-2.

EA435	\$2140
EA434	\$2140

Step 3. Casters

- For casters (5)*
- CA** 2" single wheel caster, hard floors or carpet A +\$0
 - UD** 2" hard double wheel caster, carpet, black painted A +\$0
 - VD** 2" hard double wheel caster, carpet, chrome A +\$0

Step 4. Base/Frame Finish

- L** polished aluminum A +\$0

Step 5. Fabric

See application chart and textiles list for fabric usage and numbers. First 2 digits of number indicate fabric line; remaining digit(s) indicate fabric color.

Price Category 1	+\$0
Price Category 2	+\$57
Price Category 3	+\$125
Price Category 4	+\$192
Price Category 5	+\$232
Price Category 6	+\$271
Price Category 7	+\$288
Price Category 8	+\$425
Price Category B	+\$58
Price Category E	+\$144
Price Category F	+\$201
Price Category G	+\$259
Price Category H	+\$345
Price Category R	+\$1100
Price Category V	+\$2028

Side Chair

EA430
EA431

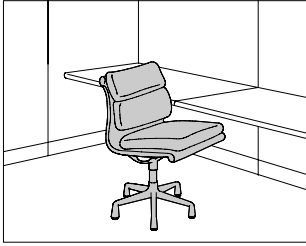

Product Information

Description

This low-back chair has a lightweight aluminum frame and 2"-thick upholstered foam cushions. It has a 5-star base with 1/2" (GD) glides for hard floors or carpet, swivel mechanism, and fixed seat height.

Notes

Chair is tested and warranted for use by persons 300 pounds and under. For description of glides, see Casters and Glides in Appendices. Customer's Own Material (COM) requires 2 1/2 yards. Customer's Own Leather (COL) requires 45 square feet. See Order Information in Appendices.

Dimensions

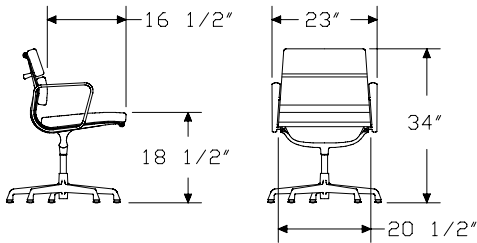

Specification Information

Step 1.

EA43

Step 2. Arms

0 no arms
1 arms A

Prices for Steps 1-2.

EA430	\$1843
EA431	\$2162

Step 3. Base/Frame Finish

L polished aluminum + \$0

Step 4. Fabric

See application chart and textiles list for fabric usage and numbers. First 2 digits of number indicate fabric line; remaining digit(s) indicate fabric color.

Price Category 1	+ \$0
Price Category 2	+ \$57
Price Category 3	+ \$125
Price Category 4	+ \$192
Price Category 5	+ \$232
Price Category 6	+ \$271
Price Category 7	+ \$288
Price Category 8	+ \$425
Price Category B	+ \$58
Price Category E	+ \$144
Price Category F	+ \$201
Price Category G	+ \$259
Price Category H	+ \$345
Price Category R	+ \$1100
Price Category V	+ \$2028

Fame's® Soft Pad Group Side Chair

Lounge Chair

EA433
EA438

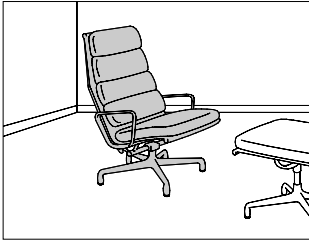

Product Information

Description

This high-back chair has a lightweight aluminum frame and 2"-thick upholstered foam cushions. It has a 5-star base with 1/2" (GD) glides for hard floors or carpet and a fixed seat height.

Notes

Chair is tested and warranted for use by persons 300 pounds and under. For description of glides, see Casters and Glides in Appendices.

Customer's Own Material (COM) requires 3 yards for 3-cushion chair and 4 yards for 4-cushion chair. Customer's Own Leather (COL) requires 56 square feet for 3-cushion chair and 63 square feet for 4-cushion chair. See Order Information in Appendices.

Dimensions

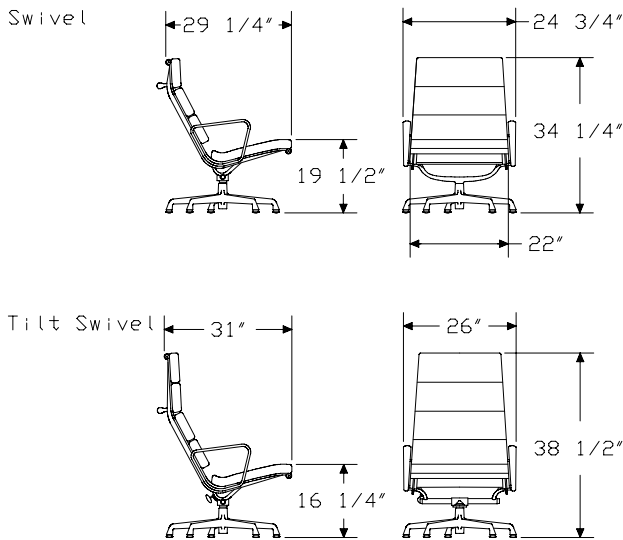

Specification Information

Step 1.

EA43

Step 2. Tilt/Number of Cushions/Arms

- 3** swivel, 3 cushions, and arms
- 8** tilt swivel, 4 cushions, and arms

Prices for Steps 1-2.

EA433	\$2711
EA438	\$2750

Step 3. Base/Frame Finish

L	polished aluminum	+ \$0
----------	-------------------	-------

Step 4. Fabric

See application chart and textiles list for fabric usage and numbers. First 2 digits of number indicate fabric line; remaining digit(s) indicate fabric color.

Price Category 1	+ \$0
Price Category 2	+ \$57
Price Category 3	+ \$135
Price Category 4	+ \$216
Price Category 5	+ \$271
Price Category 6	+ \$327
Price Category 7	+ \$349
Price Category 8	+ \$450
Price Category B	+ \$81
Price Category E	+ \$201
Price Category F	+ \$281
Price Category G	+ \$362
Price Category H	+ \$482
Price Category R	+ \$1748
Price Category V	+ \$2028

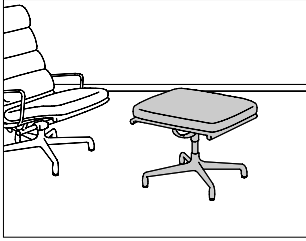

Product Information

Description

This ottoman has a lightweight aluminum frame, a 2"-thick upholstered foam cushion, and 1/2" (GD) glides for hard floors or carpet.

Notes

For description of glides, see Casters and Glides in Appendices.
 Customer's Own Material (COM) requires 1 1/4 yards. Customer's Own Leather (COL) requires 27 square feet. See Order Information in Appendices.

Dimensions

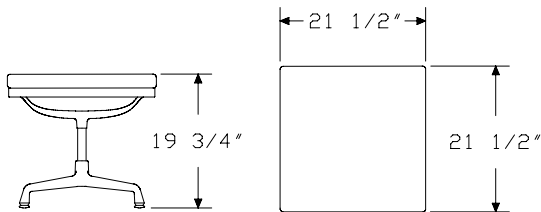

Specification Information

Step 1.

EA423 \$1144

Step 2. Base/Frame Finish

L polished aluminum +\$0

Step 3. Fabric

See application chart and textiles list for fabric usage and numbers. First 2 digits of number indicate fabric line; remaining digit(s) indicate fabric color.

Price Category 1	+\$0
Price Category 2	+\$56
Price Category 3	+\$85
Price Category 4	+\$107
Price Category 5	+\$118
Price Category 6	+\$130
Price Category 7	+\$139
Price Category 8	+\$220
Price Category B	+\$29
Price Category E	+\$72
Price Category F	+\$101
Price Category G	+\$130
Price Category H	+\$173
Price Category R	+\$550
Price Category V	+\$1828



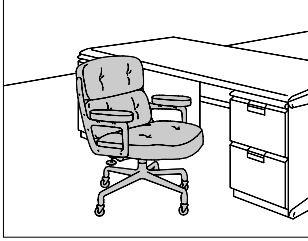

Product Information

Description

This upholstered chair has contoured seat and back cushions and padded armrests. The seat has a 4 1/2"-thick foam cushion and the back has 2 3"-thick foam cushions. It has a 5-star base, tilt-swivel mechanism, and seat-height adjustment. The chair is available with casters or glides. The chair with glides includes 1/2" (GD) glides for hard floors or carpet.

Notes

Chair is tested and warranted for use by persons 300 pounds and under. For description of casters and glides, see Casters and Glides in Appendices.

Customer's Own Material (COM) requires 3 yards. Customer's Own Leather (COL) requires 52 square feet. See Order Information in Appendices.

Dimensions

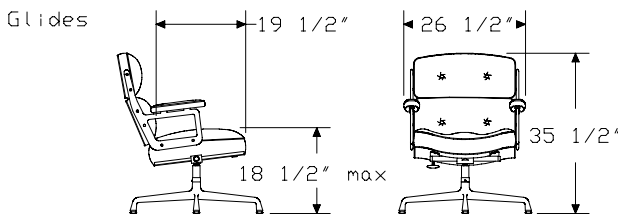
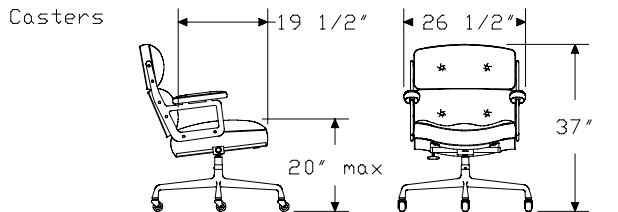

Specification Information

Step 1.

ES204 A \$3509

Step 2. Casters/Glides

CA 2" single wheel caster, hard floors or carpet A +\$0
GD 1/2" glide, hard floors or carpet A +\$0
UD 2" hard double wheel caster, carpet, black painted A +\$0
VD 2" hard double wheel caster, carpet, chrome A +\$0

Step 3. Base/Frame Finish

L polished aluminum A +\$0

Step 4. Fabric

See application chart and textiles list for fabric usage and numbers. First 2 digits of number indicate fabric line; remaining digit(s) indicate fabric color.

Price Category 1 +\$0
 Price Category 2 +\$59
 Price Category 3 +\$135
 Price Category 4 +\$216
 Price Category 5 +\$271
 Price Category 6 +\$327
 Price Category 7 +\$349
 Price Category 8 +\$450
 Price Category B +\$81
 Price Category E +\$201
 Price Category F +\$261
 Price Category G +\$362
 Price Category H +\$482
 Price Category R +\$1748
 Price Category V +\$2028



Tandem Sling Seating

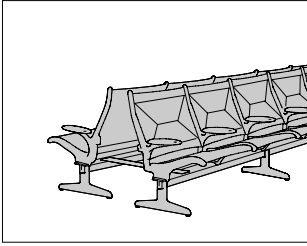

Product Information

Description

This seating product combines either a single row or back-to-back rows of seats or seats/tables in 2- to 7-unit configurations. The base is a black T-beam with polished aluminum legs and nylon glides; the sling seat is vinyl; the table is white laminate with a black vinyl edge; and the arm pads are black urethane. Shipped assembled.

The back-to-back seating product is shipped assembled as 2 single rows with 2 black connectors and hardware to connect the back-to-back rows. A back-to-back configuration that includes a table is shipped with a one-piece table to cover the back-to-back depth; attachment hardware is included.

A fire-retardant sling meets CAL 133 requirements; the sling has seats upholstered in approved fire-retardant vinyl.

Notes

For configuration options, sequence of components is from left to right when facing unit.

For 2- to 5-unit configurations, 1 table can be specified. For 6- and 7-unit configurations, 2 tables can be specified (1 for each end).

For other configurations, contact Herman Miller Options.

To retrofit single-row seating to back-to-back seating, order back-to-back base connector (TS708) separately.

Dimensions

Single

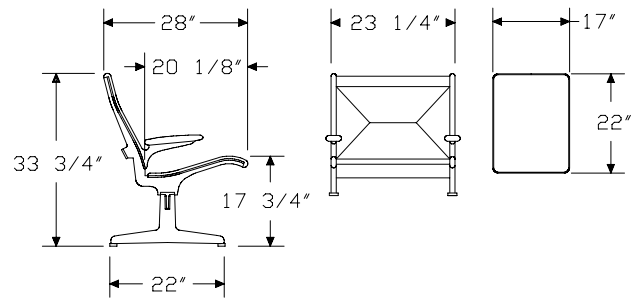

Back to Back

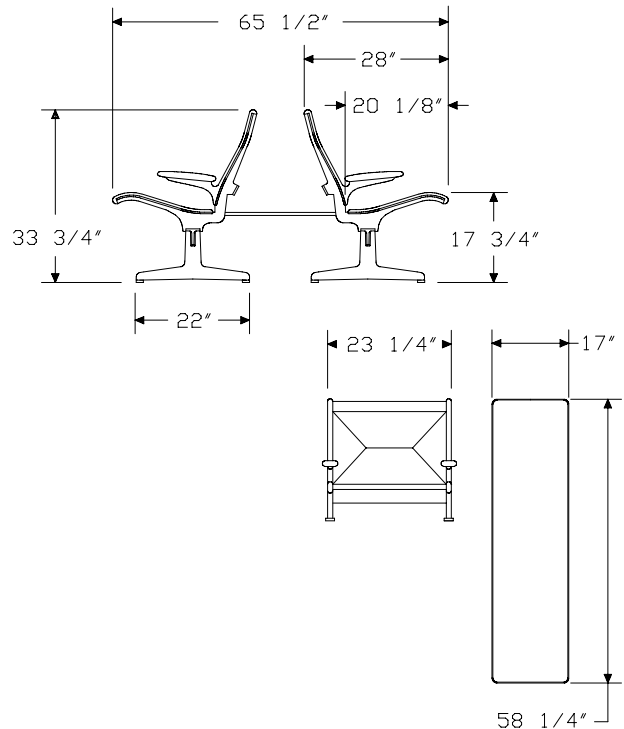

Specification Information

Step 1.

TS A

Step 2. Type

- 1 single, not fire retardant A
- 2 back to back, not fire retardant A
- 3 single, fire retardant A
- 4 back to back, fire retardant A

Step 3. Configuration

- 2SSNNNNN 2 units (2 seats) A
- 2STNNNNN 2 units (1 seat, 1 table) A
- 2TSNNNNN 2 units (1 table, 1 seat) A
- 3SSNNNNN 3 units (3 seats) A
- 3SSTNNNN 3 units (2 seats, 1 table) A
- 3STSNNNN 3 units (1 seat, 1 table, 1 seat) A
- 3TSSNNNN 3 units (1 table, 2 seats) A
- 4SSNNNNN 4 units (4 seats) A
- 4SSSTNNN 4 units (3 seats, 1 table) A
- 4SSTSNNN 4 units (2 seats, 1 table, 1 seat) A
- 4STSSNNN 4 units (1 seat, 1 table, 2 seats) A
- 4TSSNNNN 4 units (1 table, 3 seats) A
- 5SSSSN 5 units (5 seats) A
- 5SSSSTNN 5 units (4 seats, 1 table) A
- 5SSSTSNN 5 units (3 seats, 1 table, 1 seat) A
- 5SSTSSNN 5 units (2 seats, 1 table, 2 seats) A
- 5STSSN 5 units (1 seat, 1 table, 3 seats) A
- 5TSSSSN 5 units (1 table, 4 seats) A
- 6SSSSSN 6 units (6 seats) A
- 6SSSSSTN 6 units (5 seats, 1 table) A
- 6SSSSTSN 6 units (4 seats, 1 table, 1 seat) A
- 6SSSTSSN 6 units (3 seats, 1 table, 2 seats) A
- 6SSTSSSN 6 units (2 seats, 1 table, 3 seats) A
- 6STSSSN 6 units (1 seat, 1 table, 4 seats) A
- 6TSSSSN 6 units (1 table, 5 seats) A
- 6TSSSSTN 6 units (1 table, 4 seats, 1 table) A
- 7SSSSSS 7 units (7 seats) A
- 7SSSSSST 7 units (6 seats, 1 table) A
- 7SSSSSTS 7 units (5 seats, 1 table, 1 seat) A
- 7SSSSTSS 7 units (4 seats, 1 table, 2 seats) A
- 7SSSTSSS 7 units (3 seats, 1 table, 3 seats) A
- 7SSTSSSS 7 units (2 seats, 1 table, 4 seats) A
- 7STSSSSS 7 units (1 seat, 1 table, 5 seats) A
- 7TSSSSSS 7 units (1 table, 6 seats) A
- 7TSSSSST 7 units (1 table, 5 seats, 1 table) A

Prices for Steps 1-3.

TS12SSNNNNN	\$3657
TS12STNNNNN	\$3657
TS12TSNNNNN	\$3657
TS13SSNNNNN	\$4777
TS13SSTNNNN	\$4777
TS13STSNNNN	\$4777
TS13TSSNNNN	\$4777
TS14SSNNNNN	\$6074
TS14SSSTNNN	\$6074
TS14SSTSNNN	\$6074
TS14TSSNNNN	\$6074
TS14TSSSSNN	\$6074
TS15SSSSSN	\$7313
TS15SSSSTNN	\$7313
TS15SSSSTSN	\$7313
TS15SSTSSNN	\$7313
TS15STSSSN	\$7313
TS15TSSSSNN	\$7313
TS16SSSSSN	\$8493
TS16SSSSSTN	\$8493
TS16SSSSTSN	\$8493
TS16SSSTSSN	\$8493
TS16SSTSSSN	\$8493
TS16TSSSSSN	\$8493
TS16TSSSSTN	\$8493
TS17SSSSSS	\$9790
TS17SSSSSST	\$9790
TS17SSSSSTS	\$9790
TS17SSSSTSS	\$9790
TS17SSTSSSS	\$9790
TS17STSSSSS	\$9790
TS17TSSSSSS	\$9790
TS17TSSSSST	\$9790
TS22SSNNNNN	\$7460
TS22STNNNNN	\$7460
TS22TSNNNNN	\$7460
TS23SSNNNNN	\$9701
TS23SSTNNNN	\$9701
TS23STSNNNN	\$9701
TS23TSSNNNN	\$9701
TS24SSNNNNN	\$12296
TS24SSSTNNN	\$12296
TS24SSTSNNN	\$12296
TS24TSSNNNN	\$12296

Tandem Sling Seating *continued*

TS24TSSSNNN	\$12296	TS36TSSSSN	\$8833
TS25SSSSSNN	\$14773	TS36TSSSSSN	\$8833
TS25SSSSSTNN	\$14773	TS36TSSSSSTN	\$8833
TS25SSSSTSNN	\$14773	TS37SSSSSSS	\$10187
TS25SSSTSSNN	\$14773	TS37SSSSSST	\$10187
TS25STSSSNN	\$14773	TS37SSSSSTS	\$10187
TS25TSSSNN	\$14773	TS37SSSTSS	\$10187
TS26SSSSSSN	\$17131	TS37SSSTSSS	\$10187
TS26SSSSSTN	\$17131	TS37SSTSSSS	\$10187
TS26SSSSSTSN	\$17131	TS37STSSSSS	\$10187
TS26SSSTSSN	\$17131	TS37TSSSSSS	\$10187
TS26STSSSNN	\$17131	TS37TSSSSST	\$10187
TS26TSSSNN	\$17131	TS42SNNNNNN	\$7687
TS26TSSSSTN	\$17131	TS42STNNNNN	\$7687
TS27SSSSSSS	\$19726	TS42TSNNNNN	\$7687
TS27SSSSSST	\$19726	TS43SSNNNNN	\$10041
TS27SSSSSTS	\$19726	TS43SSTNNNN	\$10041
TS27SSSTSS	\$19726	TS43STNNNNN	\$10041
TS27SSTSSSS	\$19726	TS43TSSNNNN	\$10041
TS27STSSSSS	\$19726	TS44SSSNNNN	\$12750
TS27TSSSSSS	\$19726	TS44SSSTNNN	\$12750
TS27TSSSSST	\$19726	TS44SSTSNNN	\$12750
TS32SNNNNNN	\$3771	TS44STSSNNN	\$12750
TS32STNNNNN	\$3771	TS44TSSSNNN	\$12750
TS32TSNNNNN	\$3771	TS45SSSSSNN	\$15340
TS33SSSNNNN	\$4948	TS45SSSSTNN	\$15340
TS33SSTNNNN	\$4948	TS45SSSTSN	\$15340
TS33STSNNNN	\$4948	TS45STSSSNN	\$15340
TS33TSSNNNN	\$4948	TS45TSSSNN	\$15340
TS34SSSNNNN	\$6301	TS46SSSSSSN	\$17812
TS34SSSTNNN	\$6301	TS46SSSSSTN	\$17812
TS34SSTSNNN	\$6301	TS46SSSSTSN	\$17812
TS34STSSNNN	\$6301	TS46SSSTSSN	\$17812
TS34TSSSNNN	\$6301	TS46STSSSSN	\$17812
TS35SSSSSNN	\$7596	TS46TSSSSSN	\$17812
TS35SSSSSTNN	\$7596	TS46TSSSSSTN	\$17812
TS35SSSSTSN	\$7596	TS47SSSSSSS	\$20519
TS35SSSTSSN	\$7596	TS47SSSSSST	\$20519
TS35STSSSNN	\$7596	TS47SSSSSTS	\$20519
TS35TSSSNN	\$7596	TS47SSSTSS	\$20519
TS36SSSSSSN	\$8833	TS47SSSTSSS	\$20519
TS36SSSSSTN	\$8833	TS47SSTSSSS	\$20519
TS36SSSSTSN	\$8833	TS47STSSSSS	\$20519
TS36SSSTSSN	\$8833	TS47TSSSSSS	\$20519
TS36SSTSSSN	\$8833	TS47TSSSSST	\$20519

Fames® Tandem Sling Seating

Tandem Sling Seating *continued*

Eames® Tandem Sling Seating

Step 4. Fabric	
Price Category 1	+\$0

Base Connector, Back to Back

TS708

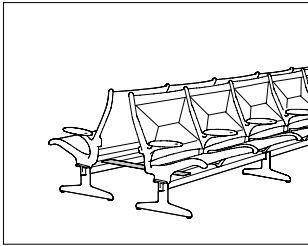

Product Information

Description

This retrofit connector joins 2 single rows of tandem sling seating products placed in back-to-back rows. The number of units and configuration must be the same for each row. Package contains 2 black connectors and hardware.

Dimensions

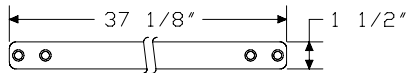

Specification Information

Step 1.

TS708 A

\$148

Fames® Tandem Sling Seating

Lounge Seating

Sofas

Molded Plywood Chairs

Molded Plastic Chairs

Wire Chair



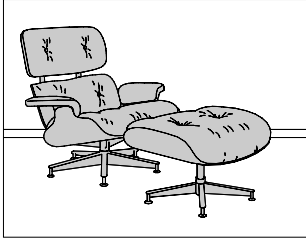

Product Information

Description

This fixed-height chair has a molded veneer seat and back shell; the ottoman has a molded veneer shell. Both the chair and ottoman have 6"-thick foam cushions with leather upholstery and a black enameled base with polished aluminum trim. The chair has a swivel mechanism.

Notes

Customer's Own Leather (COL) requires 55 square feet. See Order Information in Appendices.

Dimensions

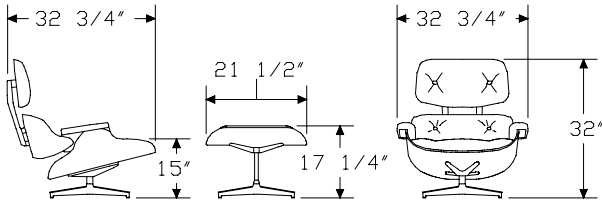

Specification Information

Step 1.

ES67071 [A] \$3757

Step 2. Shell Finish

CX	natural cherry [A]	+\$0
OU	walnut [A]	+\$0
V3	cherry [A]	+\$0
9N	santos palisander [A]	+\$1070

Step 3. Leather

See application chart and textiles list for fabric usage and numbers. First 2 digits of number indicate fabric line; remaining digit(s) indicate fabric color.

Price Category 7	+\$300
Price Category 8	+\$375
Price Category R	+\$1045
Price Category V	+\$2028

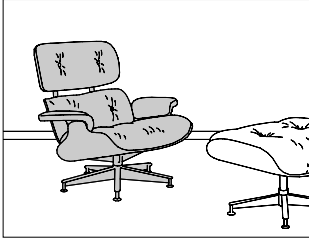

Product Information

Description

This fixed-height chair has a molded veneer seat and back shell. It has 6"-thick foam cushions with leather upholstery, a black enameled base with polished aluminum trim, and a swivel mechanism.

Notes

Customer's Own Leather (COL) requires 40 square feet. See Order Information in Appendices.

Dimensions

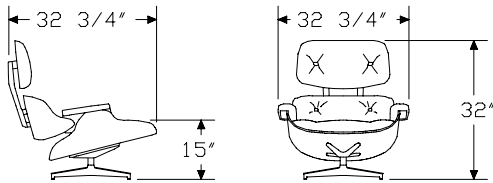

Specification Information

Step 1.

ES670 [A] \$3010

Step 2. Shell Finish

CX	natural cherry [A]	+\$0
OU	walnut [A]	+\$0
V3	cherry [A]	+\$0
9N	santos palisander [A]	+\$870

Step 3. Leather

See application chart and textiles list for fabric usage and numbers. First 2 digits of number indicate fabric line; remaining digit(s) indicate fabric color.

Price Category 7	+\$288
Price Category 8	+\$320
Price Category R	+\$990
Price Category V	+\$1928

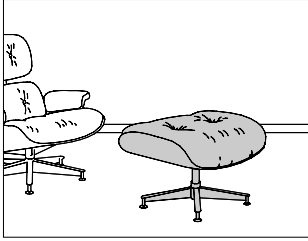

Product Information

Description

This ottoman has a molded veneer shell, 6"-thick foam cushion with leather upholstery, and black enameled base with polished aluminum trim.

Notes

Customer's Own Leather (COL) requires 15 square feet. See Order Information in Appendices.

Dimensions

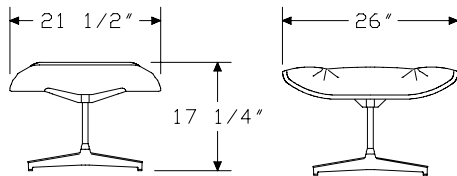

Specification Information

Step 1.

ES671 [A] \$1100

Step 2. Shell Finish

CX	natural cherry [A]	+\$0
OU	walnut [A]	+\$0
V3	cherry [A]	+\$0
9N	santos palisander [A]	+\$318

Step 3. Leather

See application chart and textiles list for fabric usage and numbers. First 2 digits of number indicate fabric line; remaining digit(s) indicate fabric color.

Price Category 7	+\$107
Price Category 8	+\$117
Price Category R	+\$452
Price Category V	+\$1828

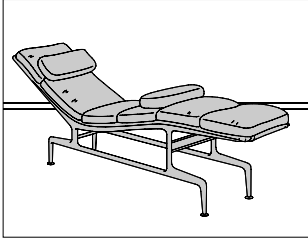

Product Information

Description
 This chaise has 6 2"-thick foam cushions with leather upholstery supported by a fabric sling. It has nylon glides and includes 2 loose cushions. Frame and base finish are black umber.

Dimensions

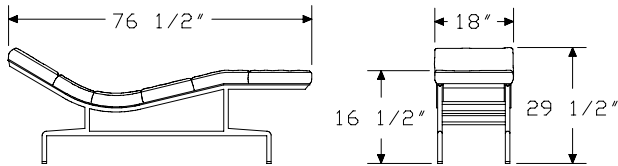

Specification Information

Step 1.
ES106 A \$5066

Step 2. Leather
See application chart and textiles list for fabric usage and numbers. First 2 digits of number indicate fabric line; remaining digit(s) indicate fabric color.

Price Category 8 + \$590
 Price Category R + \$2595



Product Information

Description

This sofa has 2½"-thick upholstered foam cushions supported by a black enameled frame. It has polished chrome-plated legs and stainless steel glides.

Notes

Customer's Own Material (COM) requires 6 yards. See Order Information in Appendices.

Dimensions

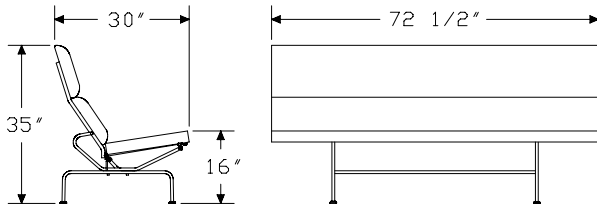

Specification Information

Step 1.

473 A \$3941

Step 2. Fabric

See application chart and textiles list for fabric usage and numbers. First 2 digits of number indicate fabric line; remaining digit(s) indicate fabric color.

Price Category 1	+\$0
Price Category 2	+\$80
Price Category 3	+\$110
Price Category 4	+\$208
Price Category 5	+\$337
Price Category 6	+\$468
Price Category B	+\$138
Price Category E	+\$345
Price Category F	+\$482
Price Category G	+\$620
Price Category H	+\$826

Sofa

ES108
ES110

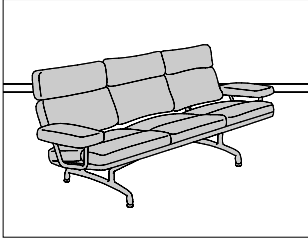

Eames® Classic Sofas

Product Information

Description

This sofa has 2"-thick upholstered foam cushions and a polished chrome-plated frame with nylon glides. The back panels are hand-finished solid walnut or solid teak.

Notes

Customer's Own Material (COM) requires 4½ yards for 2-seat sofa and 6½ yards for 3-seat sofa. Customer's Own Leather (COL) requires 100 square feet for 2-seat sofa and 125 square feet for 3-seat sofa. See Order Information in Appendices.

Dimensions

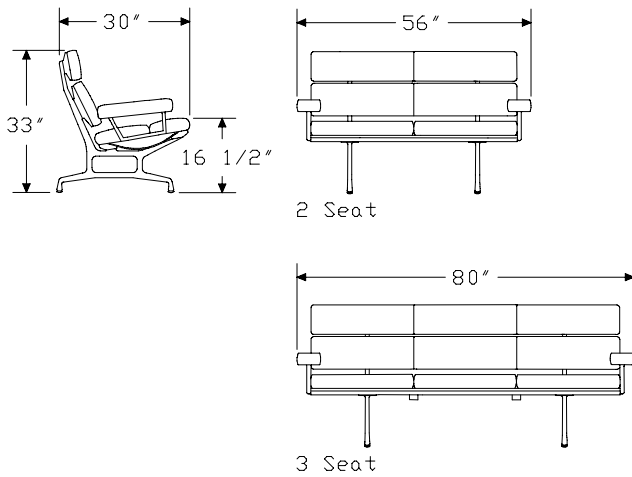

Specification Information

Step 1.

ES1 A

Step 2. Number of Seats

08 3 seats A

10 2 seats A

Prices for Steps 1-2.

ES108	\$9489
ES110	\$7858

Step 3. Back Finish

OT teak A +\$0

OU walnut A +\$0

Step 4. Base Finish

CD polished aluminum A +\$0

Step 5. Fabric

See application chart and textiles list for fabric usage and numbers. First 2 digits of number indicate fabric line; remaining digit(s) indicate fabric color.

	08	10
Price Category 1	+\$0	0
Price Category 3	+\$168	149
Price Category 5	+\$460	406
Price Category 6	+\$572	485
Price Category 7	+\$608	516
Price Category 8	+\$1151	908
Price Category R	+\$3158	2168

Lounge Chair, Metal Legs

LCM.

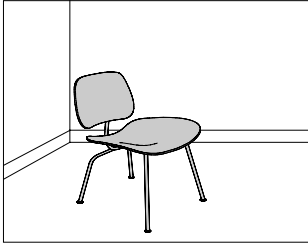

Product Information

Description

This 26 1/2"-high molded plywood chair has natural face veneers, hardwood inner plies, and a 5-ply seat and back. It has a polished chrome-plated 4-leg base and self-leveling nylon glides.

Notes

Finishes 11, 12, 13, 15, Z8, Z9, and ZQ are stain on birch veneer. These stains allow the wood grain to show through; inner plies are visible. Natural variations in wood grain may affect the appearance of these stain colors.

Avoid placement in direct sunlight.

Dimensions

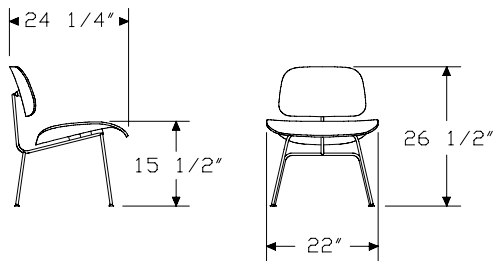

Specification Information

Step 1.

LCM. [A] \$520

Step 2. Shell Finish

Wood Veneer

AV	light ash [A]	+\$0
OU	walnut [A]	+\$0
CX	natural cherry [A]	+\$35
11	red stain [A]	+\$90
12	green stain [A]	+\$90
13	orange stain [A]	+\$90
15	black stain [A]	+\$90
Z8	light blue stain [A]	+\$90
Z9	white stain [A]	+\$90
ZQ	yellow stain [A]	+\$90

Fame's® Classic Molded Plywood Chairs

Lounge Chair, Wood Legs

LCW.

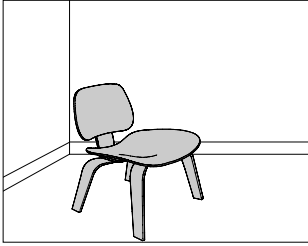

Product Information

Description

This 26½"-high molded plywood chair has natural face veneers, hardwood inner plies, a 5-ply seat and back, and 8-ply legs.

Notes

Finishes 11, 12, 13, 15, Z8, Z9, and ZQ are stain on birch veneer. These stains allow the wood grain to show through; inner plies are visible. Natural variations in wood grain may affect the appearance of these stain colors.

Avoid placement in direct sunlight.

Dimensions

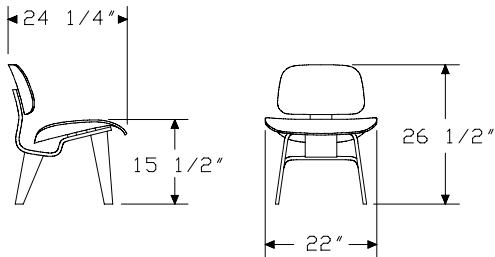

Specification Information

Step 1.

LCW. \$775

Step 2. Finish

AV	light ash <input type="checkbox"/>	+\$0
OU	walnut <input type="checkbox"/>	+\$0
CX	natural cherry <input type="checkbox"/>	+\$45
11	red stain <input type="checkbox"/>	+\$129
12	green stain <input type="checkbox"/>	+\$129
13	orange stain <input type="checkbox"/>	+\$129
15	black stain <input type="checkbox"/>	+\$129
Z8	light blue stain <input type="checkbox"/>	+\$129
Z9	white stain <input type="checkbox"/>	+\$129
ZQ	yellow stain <input type="checkbox"/>	+\$129

Dining Chair, Metal Legs

DCM.

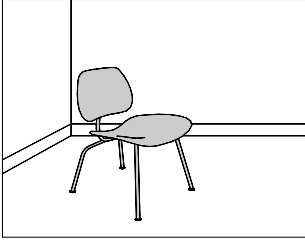

Product Information

Description

This 29¹/₂"-high molded plywood chair has natural face veneers, hardwood inner plies, and a 5-ply seat and back. It has a polished chrome-plated 4-leg base and self-leveling nylon glides.

Notes

Finishes 11, 12, 13, 15, Z8, Z9, and ZQ are stain on birch veneer. These stains allow the wood grain to show through; inner plies are visible. Natural variations in wood grain may affect the appearance of these stain colors.

Avoid placement in direct sunlight.

Dimensions

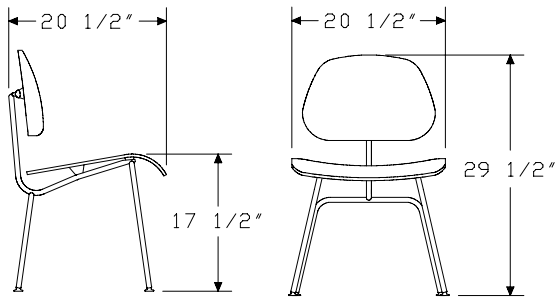

Specification Information

Step 1.

DCM. A \$468

Step 2. Shell Finish

Wood Veneer

AV	light ash <input type="checkbox"/> A	+\$0
OU	walnut <input type="checkbox"/> A	+\$0
CX	natural cherry <input type="checkbox"/> A	+\$35
11	red stain <input type="checkbox"/> A	+\$90
12	green stain <input type="checkbox"/> A	+\$90
13	orange stain <input type="checkbox"/> A	+\$90
15	black stain <input type="checkbox"/> A	+\$90
Z8	light blue stain <input type="checkbox"/> A	+\$90
Z9	white stain <input type="checkbox"/> A	+\$90
ZQ	yellow stain <input type="checkbox"/> A	+\$90

Fame's® Classic Molded Plywood Chairs

Dining Chair, Wood Legs

DCW.

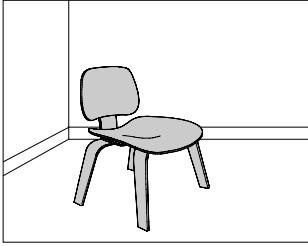

Eames® Classic Molded Plywood Chairs

Product Information

Description

This 28³/₄"-high molded plywood chair has natural face veneers, hardwood inner plies, a 5-ply seat and back, and 8-ply legs.

Notes

Finishes 11, 12, 13, 15, Z8, Z9, and ZQ are stain on birch veneer. These stains allow the wood grain to show through; inner plies are visible. Natural variations in wood grain may affect the appearance of these stain colors.

Avoid placement in direct sunlight.

Dimensions

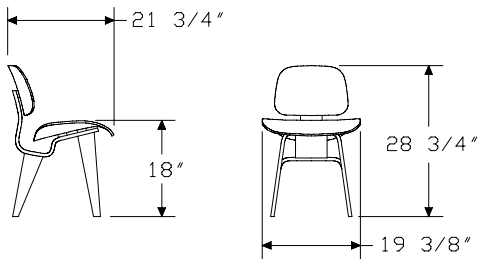

Specification Information

Step 1.

DCW. A \$727

Step 2. Finish

AV	light ash A	+\$0
OU	walnut A	+\$0
CX	natural cherry A	+\$45
11	red stain A	+\$129
12	green stain A	+\$129
13	orange stain A	+\$129
15	black stain A	+\$129
Z8	light blue stain A	+\$129
Z9	white stain A	+\$129
ZQ	yellow stain A	+\$129

Molded Plastic Side Chair

DSR.
DSSN.

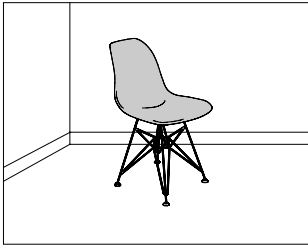

Product Information

Description

This molded chair has a flexible back, waterfall edges, and chrome legs.

Notes

4-leg-base chairs can stack up to 14 high.

Dimensions

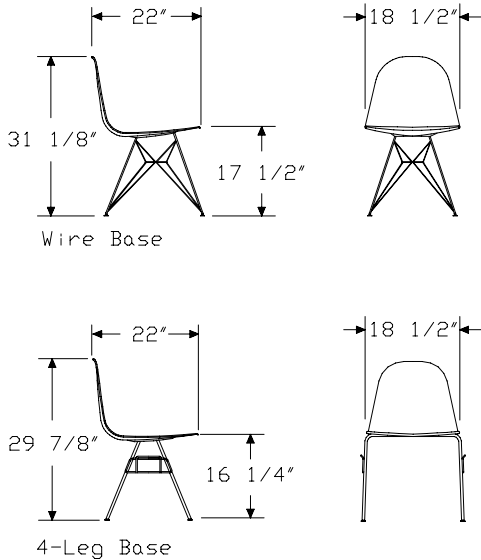

Specification Information

Step 1.

DS

Step 2. Base Option

R. wire base

SN. 4-leg base

Prices for Steps 1-2.

DSR. \$270

DSSN. \$243

Step 3. Base Finish

CH chrome +\$0

Step 4. Seat/Back Finish

ZA black +\$0

ZE red +\$0

ZF white +\$0

ZH light blue +\$0

ZS lime green +\$0

Step 5. Glide Option

E8 standard glide +\$0

E9 standard glide with felt bottom +\$0

Fame's® Classic Molded Plastic Chairs

Molded Plastic Armchair

DAR.
DAX.

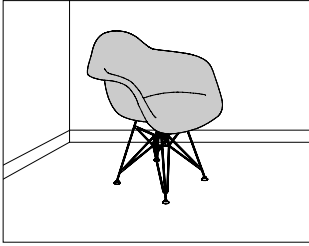

Product Information

Description

This chair has a single-piece molded back and seat with arms, waterfall edges, and chrome legs.

Dimensions

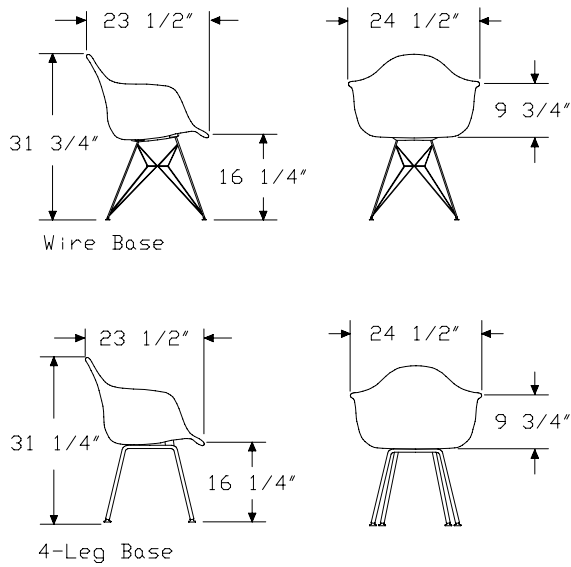

Specification Information

Step 1.

DA

Step 2. Base Option

R. wire base

X. 4-leg base

Prices for Steps 1-2.

DAR.	\$394
DAX.	\$326

Step 3. Base Finish

CH chrome +\$0

Step 4. Seat/Back Finish

ZA	black <input type="checkbox"/>	+\$0
ZE	red <input type="checkbox"/>	+\$0
ZF	white <input type="checkbox"/>	+\$0
ZH	light blue <input type="checkbox"/>	+\$0
ZS	lime green <input type="checkbox"/>	+\$0

Step 5. Glide Option

E8	standard glide <input type="checkbox"/>	+\$0
E9	standard glide with felt bottom <input type="checkbox"/>	+\$0

Molded Plastic Armchair with
Rocker Base

RAR.

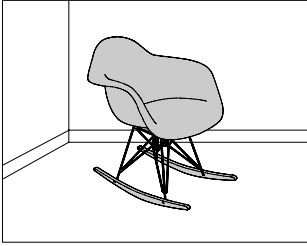

Product Information

Description

This chair has a single-piece molded seat and back with arms, waterfall edges, and chrome legs with solid-maple rockers.

Dimensions

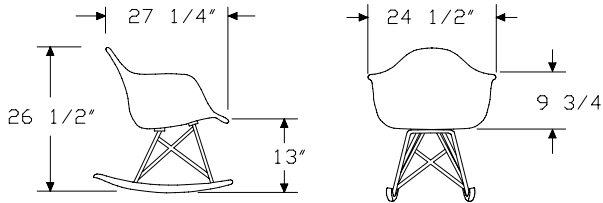

Specification Information

Step 1.

RAR. [A] \$552

Step 2. Base Finish

CH chrome [A] +\$0

Step 3. Seat/Back Finish

ZA black [A] +\$0

ZE red [A] +\$0

ZF white [A] +\$0

ZH light blue [A] +\$0

ZS lime green [A] +\$0

Fame® Classic Molded Plastic Chairs

Wire Chair

DKR.

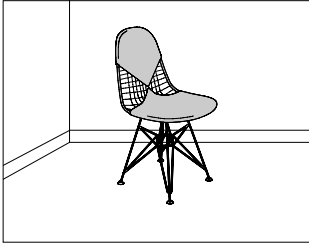

Product Information

Description

This chair has a chrome seat frame and legs. It is available with a wire seat and back, a leather seat and wire back, or a leather seat and partially upholstered leather back.

Dimensions

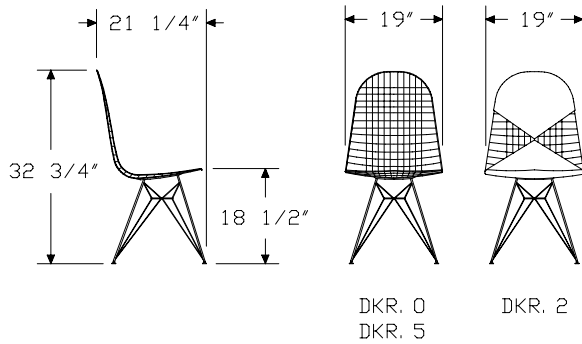

Eames® Classic Wire Chair

Specification Information

Step 1.

DKR. A

Step 2. Seat/Back Material

- 0** wire seat/wire back A
- 2** leather seat/leather back A
- 5** leather seat/wire back A

Prices for Steps 1-2.

DKR. 0	\$761
2	\$1439
5	\$1040

Step 3. Seat Frame/Leg Finish

CH chrome A + \$10

Step 4. Glide Option

- E8** standard glide A + \$0
- E9** standard glide with felt bottom A + \$0

Step 5. Leather

*For leather seat/leather back (2) or leather seat/wire back (5)
See textiles list for fabric usage and numbers. First 2 digits of number
indicate fabric line; remaining digit(s) indicate fabric color.*

Price Category 1 + \$0

Molded Chair

Armchair

DAF

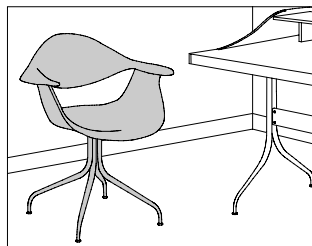

Product Information

Description

This chair has a 2-piece molded seat with arms and back, waterfall edges, a cast-aluminum base with steel-tube legs, and adjustable glides.

Notes

Seat and back sections are permanently assembled.
 Seat and back can be specified in any color combination.

Dimensions

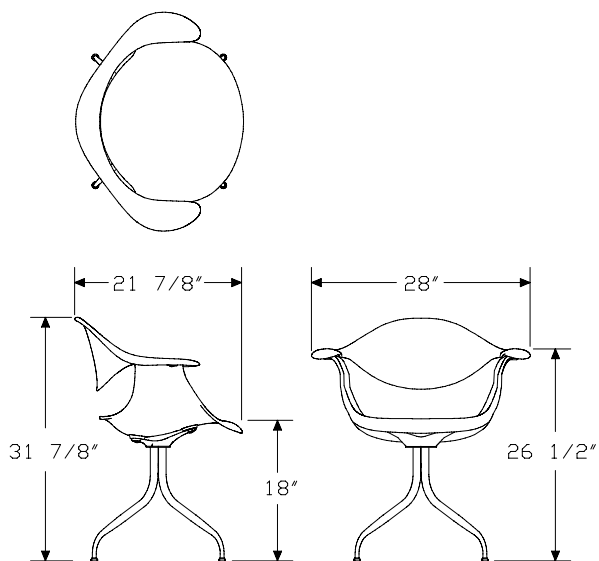

Specification Information

Step 1.

DAF A \$475

Step 2. Base Finish

91 white A +\$0
BU black umber A +\$0
CH chrome A +\$0

Step 3. Seat Finish

ZA black A +\$0
ZF white A +\$0
ZG grey A +\$0

Step 4. Back Finish

ZA black A +\$0
ZF white A +\$0
ZG grey A +\$0

Nelson™ Swag Leg Group Molded Chair

Coconut Chair

Platform Bench

Marshmallow Sofa



Coconut Chair

5569.

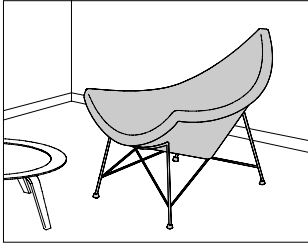

Product Information

Description

This chair has a 1-piece foam cushion upholstered in black leather, a white molded plastic shell, and a polished chrome base.

Notes

Coconut chair is upholstered in Vitra Leather, color number 9S66 Nero.

Dimensions

Specification Information

Step 1.

5569. A

\$4725

Nelson™ Coconut Chair

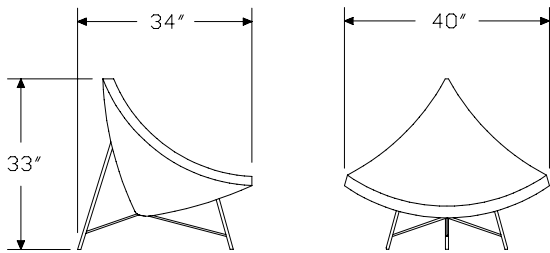

Platform Bench

PB.

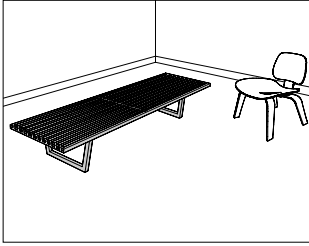

Nelson™ Platform Bench

Product Information

Description

This solid maple bench has a slatted, clear-coat maple top and an ebonized base with metal leveling glides.

Dimensions

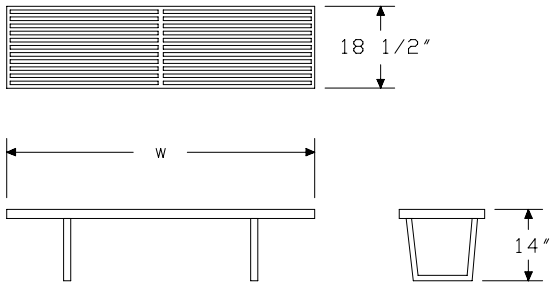

Specification Information

Step 1.

PB. A

Step 2. Width

- 48** 48" wide A
- 60** 60" wide A
- 72** 72" wide A

Prices for Steps 1-2.

PB.	48	\$814
	60	\$897
	72	\$981

Step 3. Slat Finish

Z5 maple A + \$0

Marshmallow Sofa

5670

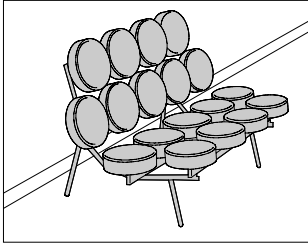

Product Information

Description

This upholstered sofa has 18 circular cushions on the back and seat, a brushed-finish tubular-steel frame, and black-satin-finish legs.

Notes

Customer's Own Material (COM) requires 3 1/2 yards. Customer's Own Leather (COL) requires 56 square feet. See Order Information in Appendices.

Dimensions

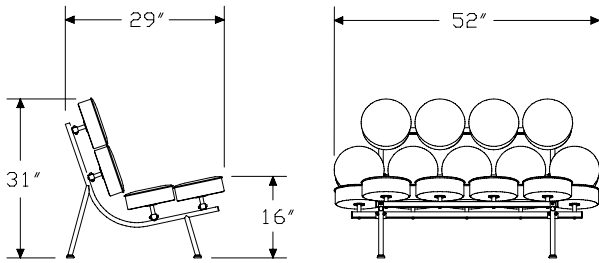

Specification Information

Step 1.

5670 [A] \$3636

Step 2. Fabric

See application chart and textiles list for fabric usage and numbers. First 2 digits of number indicate fabric line; remaining digit(s) indicate fabric color.

Price Category 1	+\$0
Price Category 2	+\$0
Price Category 7	+\$1000
Price Category 8	+\$1000
Price Category R	+\$1630
Price Category V	+\$2028

Nelson™ Marshmallow Sofa



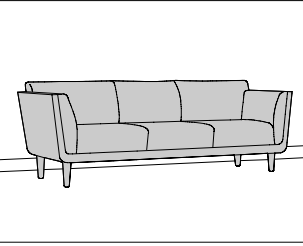

Product Information

Description

This sofa has a molded veneer frame that wraps around the sides and back. It has 7"-thick upholstered foam cushions and 4 polished cast-aluminum legs with nonadjustable nylon glides.

Notes

Customer's Own Material (COM) requires 10 yards. Customer's Own Leather (COL) requires 156 square feet. See Order Information in Appendices.

Dimensions

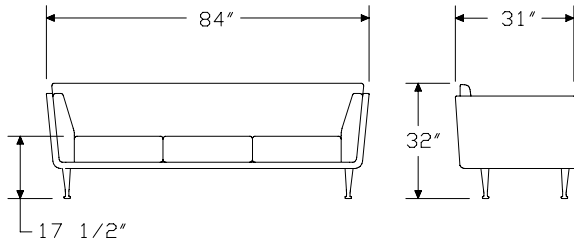

Specification Information

Step 1.

GS100. [A] \$4377

Step 2. Frame Finish

AV	light ash [A]	+\$0
OU	walnut [A]	+\$0
CX	natural cherry [A]	+\$50
EN	ebony [A]	+\$50
V3	cherry [A]	+\$50

Step 3. Seat/Back Fabric

See application chart and textiles list for fabric usage and numbers. First 2 digits of number indicate fabric line; remaining digit(s) indicate fabric color.

Price Category 1	+\$0
Price Category 2	+\$155
Price Category 3	+\$178
Price Category 4	+\$250
Price Category 5	+\$273
Price Category 6	+\$380
Price Category 7	+\$523
Price Category 8	+\$988
Price Category B	+\$115
Price Category E	+\$287
Price Category F	+\$402
Price Category G	+\$517
Price Category H	+\$689
Price Category R	+\$1950
Price Category V	+\$3042

Step 4. Accent Fabric

See application chart and textiles list for fabric usage and numbers. First 2 digits of number indicate fabric line; remaining digit(s) indicate fabric color.

Price Category 1	+\$0
Price Category 2	+\$155
Price Category 3	+\$178
Price Category 4	+\$250
Price Category 5	+\$273
Price Category 6	+\$380
Price Category 7	+\$523
Price Category 8	+\$987
Price Category B	+\$115
Price Category E	+\$287
Price Category F	+\$401
Price Category G	+\$516
Price Category H	+\$688
Price Category R	+\$1950
Price Category V	+\$3042

Stool



Capelli Stool

KC100.

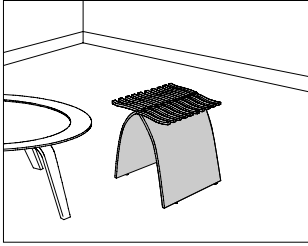

Product Information

Description

This stool has 2 molded plywood pieces that interlock to form a seat. The 2 pieces lock against one another for a strong and stable structure. The stool has 11 alternating light and dark hardwood inner plies with a light ash face veneer.

Notes

For shipping and storage, the stool unfolds and the 2 halves stack together. No tools or fasteners are required.

Dimensions

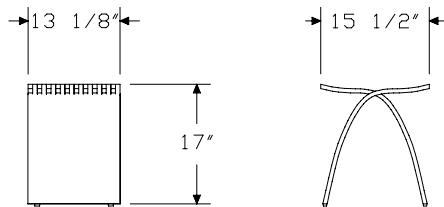

Specification Information

Step 1.

KC100. A \$601

Step 2. Finish

AV light ash A +\$0

Capelli Stool

Index by Product Name

Capelli Stool	
Capelli Stool	page(s) 63
Eames® Aluminum Group Chairs	
Executive Chair	page(s) 5
Lounge Chair	8
Management Chair	6
Ottoman	9
Side Chair	7
Eames® Classic Seating	
Chaise	page(s) 36
Dining Chair, Metal Legs	41
Dining Chair, Wood Legs	42
Lounge	34
Lounge and Ottoman	33
Lounge Chair, Metal Legs	39
Lounge Chair, Wood Legs	40
Molded Plastic Armchair	44
Molded Plastic Armchair with Rocker Base	45
Molded Plastic Side Chair	43
Ottoman	35
Sofa	38
Sofa Compact	37
Wire Chair	46
Eames® Executive Work Chair	
Executive Work Chair	page(s) 21
Eames® Soft Pad Group Chairs	
Executive Chair	page(s) 13
Lounge Chair	16
Management Chair	14
Ottoman	17
Side Chair	15
Eames® Tandem Sling Seating	
Base Connector, Back to Back	page(s) 29
Tandem Sling Seating	25
Goetz™ Sofa	
Goetz™ Sofa	page(s) 59
Nelson™ Classic Seating	
Coconut Chair	page(s) 53
Marshmallow Sofa	55
Platform Bench	54
Nelson™ Swag Leg Group	
Armchair	page(s) 49



Index by Product Number

	page(s)
473 Sofa Compact	37
5569. Coconut Chair	53
5670 Marshmallow Sofa	55
DAF Armchair	49
DAR. Molded Plastic Armchair	44
DAX.	
DCM. Dining Chair, Metal Legs	41
DCW. Dining Chair, Wood Legs	42
DKR. Wire Chair	46
DSR. Molded Plastic Side Chair	43
DSSN.	
EA323 Ottoman	9
EA330 Side Chair	7
EA331	
EA333 Lounge Chair	8
EA334 Management Chair	6
EA335	
EA337 Executive Chair	5
EA338 Lounge Chair	8
EA423 Ottoman	17
EA430 Side Chair	15
EA431	
EA433 Lounge Chair	16
EA434 Management Chair	14
EA435	
EA437 Executive Chair	13
EA438 Lounge Chair	16
ES106 Chaise	36
ES108 Sofa	38
ES110	
ES204 Executive Work Chair	21
ES670 Lounge	34
ES670 Lounge and Ottoman	33
ES671 Ottoman	35
GS100. Goetz™ Sofa	59
KC100. Capelli Stool	63
LCM. Lounge Chair, Metal Legs	39
LCW. Lounge Chair, Wood Legs	40
PB. Platform Bench	54
RAR. Molded Plastic Armchair with Rocker Base	45
TS708 Base Connector, Back to Back	29

For more information about our products and services or to see a list of dealers, please visit us at www.HermanMiller.com or call (800) 851 1196.

© 2007 Herman Miller, Inc., Zeeland, Michigan

© HermanMiller, , Abak, Action Office, Aeron, Ambi, Aside, Avive, Babble, Caper, Celle, Co/Struc, DOT, Eames, Equa 2, Ergon 3, Ethospace, FlexFront, Formcoat, Ground Cloth, Herman Miller for Healthcare, Herman Miller Options, Intersect, Kinemat, Leaf, Limerick, Meridian, Mirra, Passage, Pedastool, Pellicle, Perspectives, PostureFit, Prospects, Quadrant, Reaction, Resolve, RoomTune, Scooter, V-Wall, Vary Easy, Vivo, and Z-Axis are among the registered trademarks of Herman Miller, Inc., and its owned subsidiaries.

™ About Face, AireWeave, Ardea, Arrio, Boomerang, Bubbletack, Burdick Group, C2, Celeste, Cellular Suspension, CLT, CoActive, Compass, Cygnus, EnhancedAccess, E-Wall, Fine-Tune, Flex-Edge, Harmonic, Herman Miller for the Home, Hopsak 2, Iota, Keyless Entry, Latitude, Multiscrim, My Studio Environments, Nelson, Q, Rapunzel, Recline Selector, Stackable, Stackable Storage, Stoa, Teneo, The Be Collection, and TriFlex are among the trademarks of Herman Miller, Inc., and its owned subsidiaries.

SM TAP and Textile Alliance Program are among the service marks of Herman Miller, Inc.

Chemsurf is a registered trademark of Wilsonart International.

Corian is a registered trademark of DuPont.

FLEXNET is a trademark of Milliken & Co.

Floor Saver Glide™ is a trademark of Carpin Manufacturing Inc.

Geiger is a registered trademark of Geiger International.

Goetz is a trademark of Mark W. Goetz.

Hang-It-All is a registered trademark of Lucia Eames Demetrios, d.b.a. Eames Office.

Holophane is a registered trademark of Holophane.

Ingeo is a trademark of Cargill Dow LLC.

Microsoft and Natural Keyboard are registered trademarks of Microsoft Corporation.

Qt Quiet technology and Qt are trademarks of Cambridge Sound Management, Inc.