



Prices effective February 3, 2025

Published February 2025

Eames® Tandem Sling Seating

Introduction	page 2
Eames® Tandem Sling Seating	3
Tandem Sling Seating	5
Tandem Sling Seating with ADA Pads	8
Replacement Seat Pad	12
Base Connector, Back to Back	13
Power Kit	14
Tandem Sling Seating with Powered and Nonpowered Tables	16
Tandem Sling Seating without Arms	18
Indices	19
By Name	19
By Number	21
Appendices	
20-Day or Less/Assigned Lead-Time Order Information	
Textiles Application Chart-Seating	
Textile Colors	
For the latest materials information, refer to the Materials pages on HermanMiller.com.	

Introduction

A Note on the Organization of This Book

There are a few signals that will help you understand the organization of this book. Once you know them, you should be able to find your way around easily.

Like a newspaper, this book is formatted with columns of text and illustrations that run vertically.

Information wraps from one column to the next and continues for as many pages as it needs to.

Black bars are clues.

A black bar at the top of a page signals the start of information about a product.

This information is divided into two sections, each signaled by a black bar. Product Information includes a description, additional notes, and dimensional drawings. Specification Information, which always begins at the top of a column, includes a series of steps. Each step represents a decision you need to make in order to complete your product number. Steps must be followed sequentially. The number of pages needed to complete information on a product varies; some will be complete in one page; others may fill three or four pages. Just continue going through the steps until you run into the next product, signaled by the black bar at the top of the page.

Black tabs running along the outside edge of the page help you locate what section you are in or what section you want to go to. You can thumb forwards or backwards to find a section; tabs and text appear on both sides of the page.

The additional pages in the back of the book include the appendices and indices. They are signaled by a long black bar running along the outside edge of the page.

The index is presented two ways.

The first index is in alphabetical order by product name. It can be helpful if you are new to the products and numbering scheme or if you are looking for a type of product, such as work chair or round table.

The second index is by product number. It lists, in alphanumeric order, the base product number, typically a five-digit number.

General Information

This book is effective February 3, 2025, subject to change without notice. Products may be purchased from authorized Herman Miller dealers who will quote prices upon request. For more information about our products and services or to see a list of dealers, visit www.HermanMiller.com.

All prices are list prices. Additional services, such as planning services, design, storage, and installation, are not included and must be added to these prices when the additional services are requested.

Illustrations, specifications, and prices are based on the latest information at the time of publication. The right is reserved to make changes at any time without notice in prices, fabrics, finishes, materials, specifications, and models, and also to discontinue models and finishes.

Dimensions shown in the drawings are engineering drawing dimensions rounded up to the nearest $\frac{1}{8}$ ". Product is shipped set up or knocked down. Products that include "Shipped knocked down" in the description require some assembly. If this statement does not appear in the description, the product is shipped assembled.

Service problems are normally handled by a Herman Miller authorized dealer. Where this cannot be accomplished on a local level, service problems should be referred to the Customer Care Representative for your region, Herman Miller, Inc., Zeeland, Michigan 49464.

20-Day or Less/Assigned Lead-Time Shipments

All products and options in this price book not designated by an Assigned Program icon  will ship in **20 business days or less** after being acknowledged by Herman Miller.

Products and options designated by an  are on the assigned lead-time program and may ship in 20 days, less than 20 days, or more than 20 days from order acknowledgement.

Tandem Sling Seating

TS12S	TS16T	TS25S
TS12T	TS17S	TS25T
TS13S	TS17T	TS26S
TS13T	TS22S	TS26T
TS14S	TS22T	TS27S
TS14T	TS23S	TS27T
TS15S	TS23T	
TS15T	TS24S	
TS16S	TS24T	

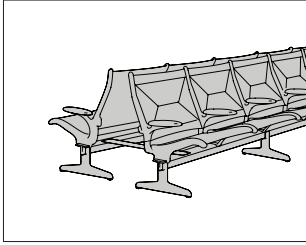

Product Information

Description

This seating product combines either a single row or back-to-back rows of seats or seats/tables in 2- to 7-unit configurations. The base is a black T-beam with polished aluminum legs and nylon glides; the sling seat is vinyl; the table is white laminate with a black thermoplastic edge; and the arm pads are black urethane. Shipped assembled.

The back-to-back seating product is shipped assembled as 2 single rows with 2 black connectors and hardware to connect the back-to-back rows. A back-to-back configuration that includes a table is shipped with a one-piece table to cover the back-to-back depth; attachment hardware is included.

Notes

For configuration options, sequence of components is from left to right when facing unit.

For 2- to 5-unit configurations, 1 table can be specified. For 6- and 7-unit configurations, 2 tables can be specified (1 for each end).

For other configurations, contact Herman Miller Options.

To retrofit single-row seating to back-to-back seating, order back-to-back base connector (TS708) separately.

Dimensions

Single

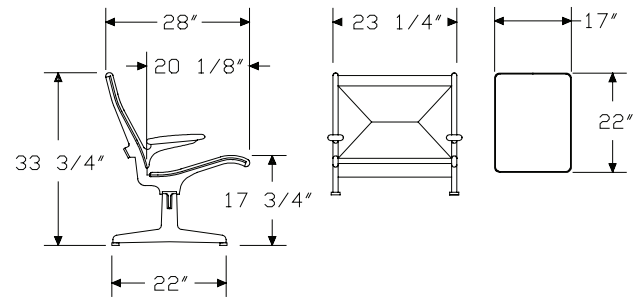

Back to Back

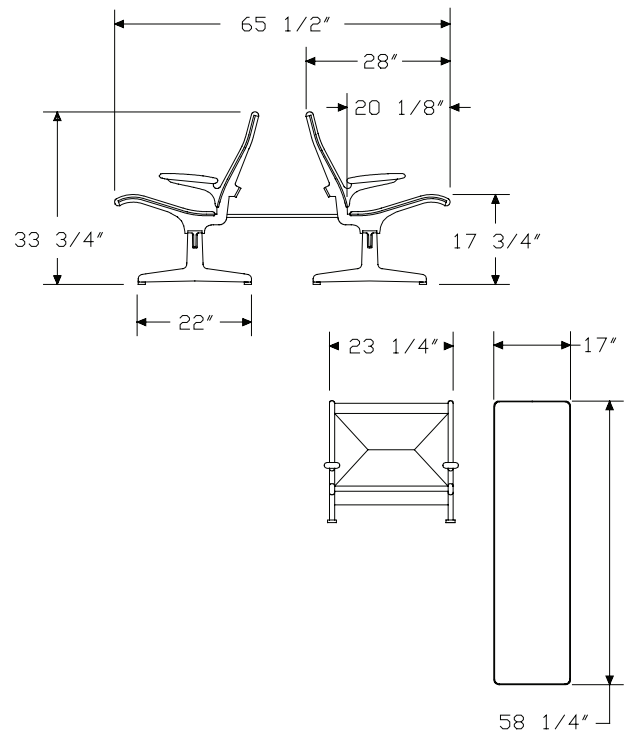

Specification Information

Step 1.

TS A

Step 2. Type

- 1 single
- 2 back to back A

Step 3. Configuration

- 2SSNNNN 2 units (2 seats) A
- 2STNNNN 2 units (1 seat, 1 table) A
- 2TSNNNN 2 units (1 table, 1 seat) A
- 3SSNNNN 3 units (3 seats) A
- 3STNNNN 3 units (2 seats, 1 table) A
- 3STSNNN 3 units (1 seat, 1 table, 1 seat) A
- 3TSSNNNN 3 units (1 table, 2 seats) A
- 4SSNNNN 4 units (4 seats) A
- 4SSSTNN 4 units (3 seats, 1 table) A
- 4SSTSN 4 units (2 seats, 1 table, 1 seat) A
- 4STSSNN 4 units (1 seat, 1 table, 2 seats) A
- 4TSSNNNN 4 units (1 table, 3 seats) A
- 5SSSSNN 5 units (5 seats) A
- 5SSSSTNN 5 units (4 seats, 1 table) A
- 5SSSTSN 5 units (3 seats, 1 table, 1 seat) A
- 5STSSNN 5 units (2 seats, 1 table, 2 seats) A
- 5TSSSN 5 units (1 seat, 1 table, 3 seats) A
- 5TSSSN 5 units (1 table, 4 seats) A
- 6SSSSSN 6 units (6 seats) A
- 6SSSSSTN 6 units (5 seats, 1 table) A
- 6SSSSTSN 6 units (4 seats, 1 table, 1 seat) A
- 6SSSTSN 6 units (3 seats, 1 table, 2 seats) A
- 6STSSSN 6 units (2 seats, 1 table, 3 seats) A
- 6TSSSN 6 units (1 seat, 1 table, 4 seats) A
- 6TSSSN 6 units (1 table, 5 seats) A
- 6TSSSTN 6 units (1 table, 4 seats, 1 table) A
- 7SSSSSS 7 units (7 seats) A
- 7SSSSST 7 units (6 seats, 1 table) A
- 7SSSSST 7 units (5 seats, 1 table, 1 seat) A
- 7SSSTSS 7 units (4 seats, 1 table, 2 seats) A
- 7SSSTSS 7 units (3 seats, 1 table, 3 seats) A
- 7STSSSS 7 units (2 seats, 1 table, 4 seats) A
- 7TSSSSS 7 units (1 seat, 1 table, 5 seats) A
- 7TSSSSS 7 units (1 table, 6 seats) A
- 7TSSSSST 7 units (1 table, 5 seats, 1 table) A

Prices for Steps 1-3.

TS12SSNNNNN \$5632

TS12STNNNNN	\$5632
TS12TSNNNNN	\$5632
TS13SSNNNNN	\$7356
TS13SSTNNNN	\$7356
TS13STNNNNN	\$7356
TS13TSSNNNN	\$7356
TS14SSSSNNN	\$9351
TS14SSTNNN	\$9351
TS14SSTSN	\$9351
TS14STSSNN	\$9351
TS14TSSNNN	\$9351
TS15SSSSNN	\$11259
TS15SSSSTNN	\$11259
TS15SSTSN	\$11259
TS15SSTSSN	\$11259
TS15STSSNN	\$11259
TS15TSSSSNN	\$11259
TS16SSSSSSN	\$13076
TS16SSSSSTN	\$13076
TS16SSSSTSN	\$13076
TS16SSTSSN	\$13076
TS16STSSSN	\$13076
TS16TSSSSN	\$13076
TS16TSSSSTN	\$13076
TS17SSSSSSS	\$15069
TS17SSSSSST	\$15069
TS17SSSSSTS	\$15069
TS17SSSSTSS	\$15069
TS17SSTSSS	\$15069
TS17STSSSS	\$15069
TS17TSSSSS	\$15069
TS17TSSSST	\$15069
TS22SSNNNNN	\$11485
TS22STNNNNN	\$11485
TS22TSNNNNN	\$11485
TS23SSNNNNN	\$14935
TS23SSTNNNN	\$14935
TS23STSNNNN	\$14935
TS23TSSNNNN	\$14935
TS24SSSSNNN	\$18929
TS24SSTNNN	\$18929
TS24SSTSN	\$18929
TS24STSSNN	\$18929
TS24TSSNNN	\$18929
TS25SSSSSN	\$22739

Tandem Sling Seating *continued*

TS25SSSSTNN	\$22739
TS25SSSSTSN	\$22739
TS25SSSSTSSN	\$22739
TS25STSSSN	\$22739
TS25TSSSN	\$22739
TS26SSSSSN	\$26369
TS26SSSSTN	\$26369
TS26SSSSTSN	\$26369
TS26SSSSTSSN	\$26369
TS26STSSSN	\$26369
TS26TSSSN	\$26369
TS26TSSSTN	\$26369
TS27SSSSSS	\$30362
TS27SSSSSST	\$30362
TS27SSSSSTS	\$30362
TS27SSSSTSS	\$30362
TS27SSSSTSSS	\$30362
TS27SSTSSSS	\$30362
TS27STSSSSS	\$30362
TS27TSSSSSS	\$30362
TS27TSSSSST	\$30362

Step 4. Fabric	
Price Category 1 <input type="checkbox"/> A	+\$0
Price Category 2	+\$0

Tandem Sling Seating with ADA Pads

TSA1A
TSA1B
TSA1C
TSA2A
TSA2B
TSA2C

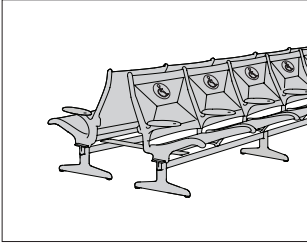

Eames® Tandem Sling Seating

Product Information

Description

This seating product combines either a single row or back-to-back rows of seats or seats/tables in 2- to 7-unit configurations with ADA symbols on selected pads. The base is a black T-beam with polished aluminum legs and nylon glides; the sling seat is vinyl; the table is white laminate with a black thermoplastic edge; and the armpads are black urethane. Shipped assembled.

The back-to-back seating product is shipped assembled as 2 single rows with 2 black connectors and hardware to connect the back-to-back rows. A back-to-back configuration that includes a table is shipped with a one-piece table to cover the back-to-back depth; attachment hardware is included.

Notes

For configuration options, sequence of components is from left to right when facing unit. "A" denotes an ADA pad, and "S" denotes a regular pad.

For configurations with a table, specify all ADA pads (A) only. All other configurations contain no tables.

ADA pad is placed on the back pad of the unit.

For seat types single (1, 3), with pad type (A), all backs for each seat are specified with ADA pads. With pad type (B), the unit specified will contain only 1 ADA pad. With pad type (C), the unit specified will contain 2 ADA pads.

For seat types back to back (2, 4), with pad type (A), all backs for each seat are specified with ADA pads. With pad type (B), the unit specified will contain 2 ADA pads. With pad type (C), the unit specified will contain 4 ADA pads.

For other configurations, contact Herman Miller Options.

To retrofit single-row seating to back-to-back seating, order back-to-back base connector (TS708) separately.

Dimensions

Single

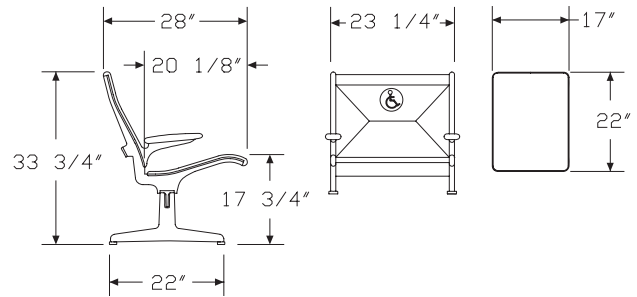

Back to Back

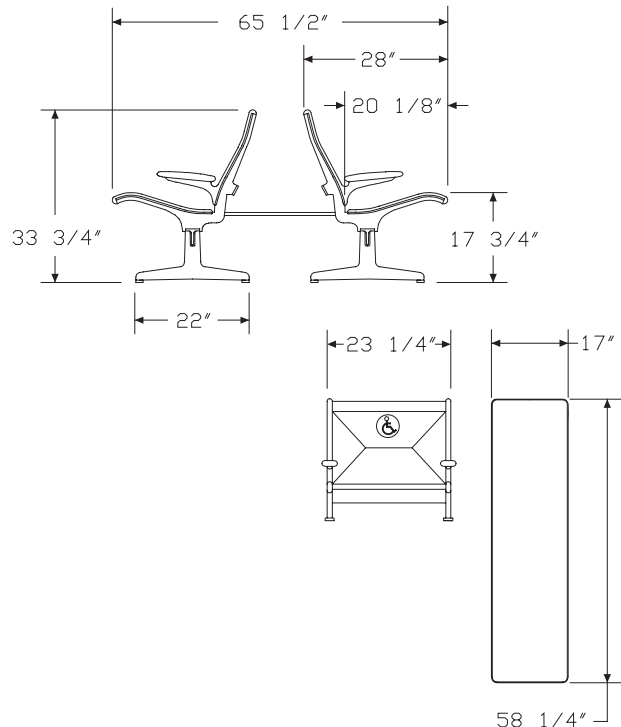

Tandem Sling Seating with ADA Pads

continued

Specification Information

Step 1.

TSA

Step 2. Type

- 1 single
- 2 back to back

Step 3. Pad Type

- A all ADA pad
- B single ADA pad
- C double ADA pad

Step 4. Configuration

For all ADA pad (A)

- 2AANNNN2 units (2 ADA seats)
- 3AAANNN3 units (3 ADA seats)
- 3AATNNN3 units (2 ADA seats, 1 table)
- 3ATANNN3 units (1 ADA seat, 1 table, 1 ADA seat)
- 3TAANNN3 units (1 table, 2 ADA seats)
- 4AAAAAN4 units (4 ADA seats)
- 4AAATNN4 units (3 ADA seats, 1 table)
- 4AATANN4 units (2 ADA seats, 1 table, 1 ADA seat)
- 4ATAANN4 units (1 ADA seat, 1 table, 2 ADA seats)
- 4TAAANN4 units (1 table, 3 ADA seats)
- 5AAAAAN5 units (5 ADA seats)
- 5AAATNN5 units (4 ADA seats, 1 table)
- 5AAATANN5 units (3 ADA seats, 1 table, 1 ADA seat)
- 5AATAANN5 units (2 ADA seats, 1 table, 2 ADA seats)
- 5ATAAANN5 units (1 ADA seat, 1 table, 3 ADA seats)
- 5TAAANN5 units (1 table, 4 ADA seats)
- 6AAAAAN6 units (6 ADA seats)
- 6AAAAATN6 units (5 ADA seats, 1 table)
- 6AAATANN6 units (4 ADA seats, 1 table, 1 ADA seat)
- 6AAATAAN6 units (3 ADA seats, 1 table, 2 ADA seats)
- 6AATAAAN6 units (2 ADA seats, 1 table, 3 ADA seats)
- 6ATAAAN6 units (1 ADA seat, 1 table, 4 ADA seats)
- 6TAAAN6 units (1 table, 5 ADA seats)
- 6TAAATN6 units (1 table, 4 ADA seats, 1 table)
- 7AAAAAA7 units (7 ADA seats)
- 7AAAAAT7 units (6 ADA seats, 1 table)
- 7AAAAATA7 units (5 ADA seats, 1 table, 1 ADA seat)
- 7AAATAA7 units (4 ADA seats, 1 table, 2 ADA seats)
- 7AATAAA7 units (3 ADA seats, 1 table, 3 ADA seats)
- 7AATAAAA7 units (2 ADA seats, 1 table, 4 ADA seats)
- 7ATAAAA7 units (1 ADA seat, 1 table, 5 ADA seats)
- 7TAAAAA7 units (1 table, 6 ADA seats)
- 7TAAAAAT7 units (1 table, 5 ADA seats, 1 table)

Tandem Sling Seating with ADA Pads

continued

Eames® Tandem Sling Seating

For single ADA pad (B)

2ASNNNNN	2 units (1 ADA seat, 1 seat)	<input type="checkbox"/>
2SANNNNN	2 units (1 seat, 1 ADA seat)	<input type="checkbox"/>
3ASSNNNN	3 units (1 ADA seat, 2 seats)	<input type="checkbox"/>
3SSANNNN	3 units (2 seats, 1 ADA seat)	<input type="checkbox"/>
4ASSSNNN	4 units (1 ADA seat, 3 seats)	<input type="checkbox"/>
4SSSANNN	4 units (3 seats, 1 ADA seat)	<input type="checkbox"/>
5ASSSSNN	5 units (1 ADA seat, 4 seats)	<input type="checkbox"/>
5SSSSANN	5 units (4 seats, 1 ADA seat)	<input type="checkbox"/>
6ASSSSSN	6 units (1 ADA seat, 5 seats)	<input type="checkbox"/>
6SSSSSAN	6 units (5 seats, 1 ADA seat)	<input type="checkbox"/>
7ASSSSSS	7 units (1 ADA seat, 6 seats)	<input type="checkbox"/>
7SSSSSSA	7 units (6 seats, 1 ADA seat)	<input type="checkbox"/>

For double ADA pad (C)

3AASNNNN	3 units (2 ADA seats, 1 seat)	<input type="checkbox"/>
3SAANNNN	3 units (1 seat, 2 ADA seats)	<input type="checkbox"/>
4AASSNNN	4 units (2 ADA seats, 2 seats)	<input type="checkbox"/>
4SSAANNN	4 units (2 seats, 2 ADA seats)	<input type="checkbox"/>
5AASSSNN	5 units (2 ADA seats, 3 seats)	<input type="checkbox"/>
5SSSAANN	5 units (3 seats, 2 ADA seats)	<input type="checkbox"/>
6AASSSSN	6 units (2 ADA seats, 4 seats)	<input type="checkbox"/>
6SSSSAAN	6 units (4 seats, 2 ADA seats)	<input type="checkbox"/>
7AASSSSS	7 units (2 ADA seats, 5 seats)	<input type="checkbox"/>
7SSSSSAA	7 units (5 seats, 2 ADA seats)	<input type="checkbox"/>

Prices for Steps 1-4.

TSA1A	2AANNNNN	\$5791
	3AAANNNN	\$7593
	3AATNNNN	\$7514
	3ATANNNN	\$7514
	3TAANNNN	\$7514
	4AAAANNN	\$9668
	4AAATNNN	\$9590
	4AATANNN	\$9590
	4ATAANNN	\$9590
	4TAAANNN	\$9590
	5AAAAANN	\$11655
	5AAAATNN	\$11576
	5AAATANN	\$11576
	5AATAANN	\$11576
	5ATAAANN	\$11576
	5TAAANNN	\$11576
	6AAAAAAN	\$13550
	6AAAAATN	\$13471
	6AAAATAN	\$13471
	6AAATAAN	\$13471
	6AATAAAN	\$13471
	6ATAAAAN	\$13471
	6TAAAAAN	\$13471
	6TAAAAATN	\$13392
	7AAAAAAA	\$15624
	7AAAAAAT	\$15546
	7AAAAATA	\$15546
	7AAAATAA	\$15546
	7AAATAAA	\$15546
	7AATAAAA	\$15546
	7ATAAAAA	\$15546
	7TAAAAAA	\$15546
	7TAAAAAT	\$15467

TSA1B	2ASNNNNN	\$5710
	2SANNNNN	\$5710
	3ASSNNNN	\$7435
	3SSANNNN	\$7435
	4ASSSNNN	\$9431
	4SSSANNN	\$9431
	5ASSSSNN	\$11338
	5SSSSANN	\$11338
	6ASSSSSN	\$13152
	6SSSSSAN	\$13152
	7ASSSSSS	\$15150
	7SSSSSSA	\$15150

Tandem Sling Seating with ADA Pads

continued

TSA1C	3AASNNNN	\$7514
	3SAANNNN	\$7514
	4AASSNNN	\$9511
	4SSAANNN	\$9511
	5AASSSNN	\$11418
	5SSSAANN	\$11418
	6AASSSSN	\$13232
	6SSSSAAN	\$13232
	7AASSSSS	\$15230
	7SSSSSAA	\$15230

TSA2A	2AANNNNN	\$11642
	3AAANNNN	\$15172
	3AATNNNN	\$15093
	3ATANNNN	\$15093
	3TAANNNN	\$15093
	4AAAANNN	\$19245
	4AAATNNN	\$19165
	4AATANNN	\$19165
	4ATAANNN	\$19165
	4TAAANNN	\$19165
	5AAAAANN	\$23135
	5AAAATNN	\$23058
	5AAATANN	\$23058
	5AATAANN	\$23058
	5ATAAANN	\$23058
	5TAAAANN	\$23058
	6AAAAAAN	\$26844
	6AAAAATN	\$26765
	6AAAATAN	\$26765
	6AAATAAN	\$26765
	6AATAAAN	\$26765
	6ATAAAN	\$26765
	6TAAAAAN	\$26765
	6TAAAAATN	\$26686
	7AAAAAAA	\$30918
	7AAAAAAT	\$30838
	7AAAAATA	\$30838
	7AAAATAA	\$30838
	7AAATAAA	\$30838
	7AATAAAA	\$30838
	7ATAAAAA	\$30838
	7TAAAAAA	\$30838
	7TAAAAAT	\$30758

TSA2B	2ASNNNNN	\$11562
	2SANNNNN	\$11562
	3ASSNNNN	\$15016
	3SSANNNN	\$15016
	4ASSSNNN	\$19008
	4SSSANNN	\$19008
	5ASSSSNN	\$22820
	5SSSSANN	\$22820
	6ASSSSSN	\$26449
	6SSSSSAN	\$26449
	7ASSSSSS	\$30441
	7SSSSSAA	\$30441

TSA2C	3AASNNNN	\$15093
	3SAANNNN	\$15093
	4AASSNNN	\$19089
	4SSAANNN	\$19089
	5AASSSNN	\$22899
	5SSSAANN	\$22899
	6AASSSSN	\$26528
	6SSSSAAN	\$26528
	7AASSSSS	\$30522
	7SSSSSAA	\$30522

Step 5. Fabric	
Price Category 2	+\$0
Price Category 3	+\$0

Eames® Tandem Sling Seating

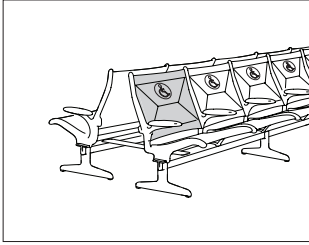

Eames® Tandem Sling Seating

Product Information

Description

This replacement pad for Tandem Sling Seating can be ordered as standard or with an embroidered logo for ADA compliance. Pads can be used to replace the seat or the back of the seating unit.

Dimensions

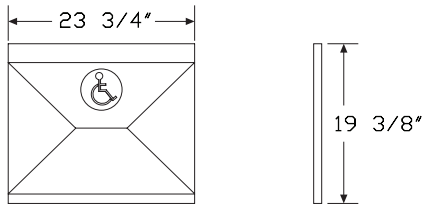

Specification Information

Step 1.

TS900 A

Step 2. Pad Type

S standard A

A ADA logo pad A

Prices for Steps 1-2.

TS900 S	\$361
A	\$485

Step 3. Fabric

For ADA logo pad (A)

Price Category 2	+\$0
Price Category 3	+\$0

For standard (S)

Price Category 1 <input type="checkbox"/> A	+\$0
Price Category 2	+\$0
Price Category 3	+\$0

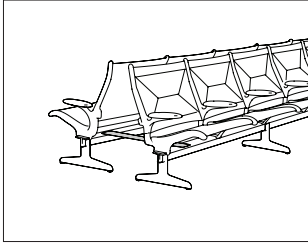

Product Information

Description

This retrofit connector joins 2 single rows of tandem sling seating products placed in back-to-back rows. The number of units and configuration must be the same for each row. Package contains 2 black connectors and hardware.

Dimensions

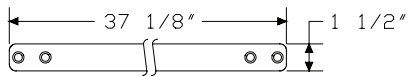

Specification Information

Step 1.

TS708 A

\$395

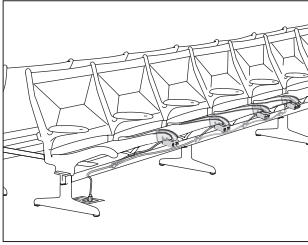

Eames® Tandem Sling Seating

Product Information

Description

This electrical distributor plugs directly into floor, wall or ceiling drop outlets. Each module configuration presents the same visual appearance. Finish is black. Retrofit brackets, cable clips, and attachment hardware included. Product is ETL listed to UL962A.

Notes

- Length between center points of each split point is 24".
- Cord length from plug end to first split point is 84". All branch lengths from main power cord to module are 19".
- Power modules are 15-amp single circuit AC with tamper-resistant (TR) receptacles.
- USB ports provide a combined 20 watts of power to charge most devices and tablets at full speed. USB-C port provides 15 watts of power and USB-A port provides 10 watts of power individually. If using both USB-C and USB-A ports, USB-C remains at 15 watts and USB-A drops to 5 watts.
- Cord head contains a circuit breaker when there are more than 4 simplex receptacles.
- All power cords contain a reset GFCI.

Dimensions

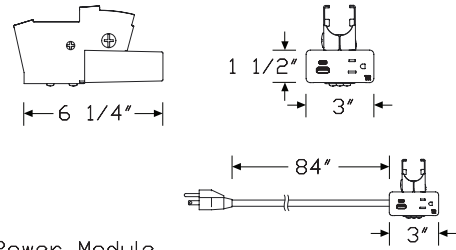

Single Power Module

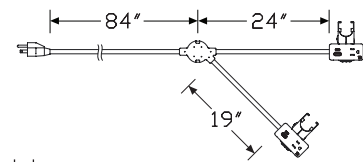

Two Power Modules

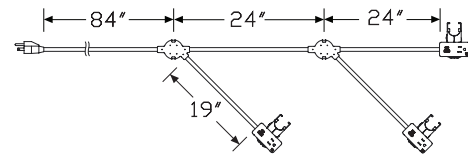

Three Power Modules

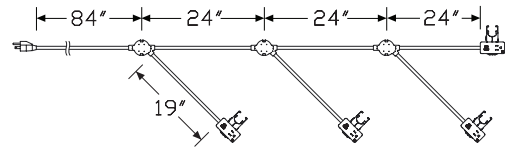

Four Power Modules

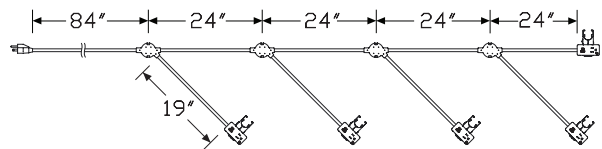

Five Power Modules

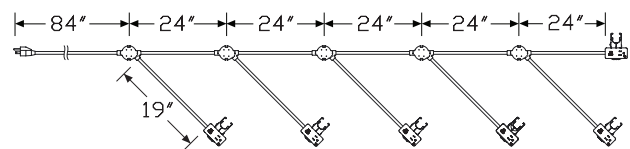

Six Power Modules

Tandem Sling Seating Power Kit

continued

Specification Information

Step 1.

TSPK.

Step 2. Power Frequency

- 1 power every chair
- 2 power every other chair

Step 3. Number of Modules/Connection

For power every chair (1)

- 1 one power module & 1 retrofit bracket
- 2 two power modules & 2 retrofit brackets
- 3 three power modules & 3 retrofit brackets
- 4 four power modules & 4 retrofit brackets
- 5 five power modules & 5 retrofit brackets
- 6 six power modules & 6 retrofit brackets

For power every other chair (2)

- 2 two power modules & 2 retrofit brackets
- 3 three power modules & 3 retrofit brackets

Step 4. Power Type

For one power module & 1 retrofit bracket (1), two power modules & 2 retrofit brackets (2), three power modules & 3 retrofit brackets (3), or four power modules & 4 retrofit brackets (4)

- L 1 simplex receptacles, 1 powered USB A/C Combo
- K 2 simplex receptacles

For five power modules & 5 retrofit brackets (5) or six power modules & 6 retrofit brackets (6)

- L 1 simplex receptacles, 1 powered USB A/C Combo

Step 5. Cord Length

- 07 7' cord

Prices for Steps 1-5.

			L07	K07
TSPK.	1	1	\$1295	973
		2	\$1941	1454
		3	\$2586	1941
		4	\$3231	2423
		5	\$3876	—
		6	\$4523	—
	2	2	\$1953	1469
		3	\$2599	1953

Tandem Sling Seating with Powered and Nonpowered Tables TSPT.

Eames® Tandem Sling Seating

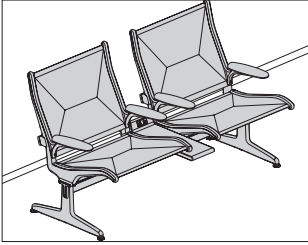

Product Information

Description

This seating product combines rows of seats or seats/tables in 2- to 6-unit configurations. The base is a black T-beam with polished aluminum legs and nylon glides; the sling seat is vinyl; the table is die cast aluminum painted black; and the armpads are black urethane. The product can be configured with 2 arms, 1 arm or no arms alongside the table with powered or nonpowered tables. Shipped assembled.

Notes

For configuration options, sequence of components is from left to right when facing unit.

For 2- to 3-unit configurations, 1 table can be specified. For 4- to 6-unit configurations, 2 tables can be specified (1 for each end).

Power modules are 15-amp single circuit AC with tamper-resistant (TR) receptacles.

USB ports provide a combined 20 watts of power to charge most devices and tablets at full speed. USB-C port provides 15 watts of power and USB-A port provides 10 watts of power individually. If using both USB-C and USB-A ports, USB-C remains at 15 watts and USB-A drops to 5 watts.

For other configurations, contact Herman Miller Options.

To retrofit single-row seating to back-to-back seating, order back-to-back base connector (TS708) separately.

Dimensions

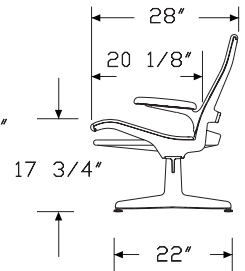
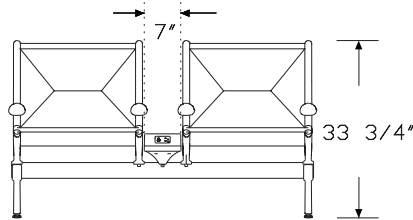
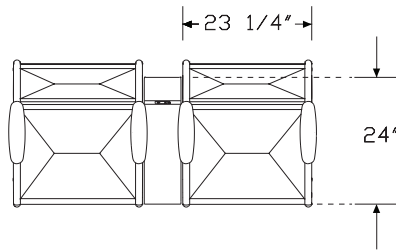

Back to Back

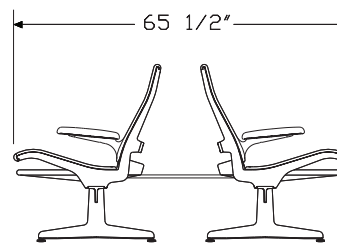

Tandem Sling Seating with Powered and Nonpowered Tables *continued*

Specification Information

Step 1.

TSPT. A

Step 2. Configuration

- 20 2 seat unit (1 seat, 1 table, 1 seat) A
- 30 3 seat unit (1 seat, 1 tables, 2 seat) A
- 31 3 seat unit (2 seat, 1 tables, 1 seat) A
- 40 4 seat unit (1 seat, 1 table, 2 seats, 1 table, 1 seat) A
- 50 5 seat unit (1 seat, 1 table, 3 seats, 1 table, 1 seat) A
- 60 6 seat unit (1 seat, 1 table, 4 seats, 1 table, 1 seat) A

Step 3. Handed Table Option (access from a seated position)

- N complete arm free unit A
- R table with 1 arm A
- T table with 2 arms A

Step 4. Table Type

- N nonpowered table A
- P powered table A

Step 5. Power Type

For powered table (P)

- L 1 simplex receptacles, 1 powered USB A/C Combo A
- K 2 simplex receptacles A

Step 6. Cord Length

For powered table (P)

- 07 7' cord A

Step 7. Cord Exit (from a seated position)

For powered table (P)

- L left hand cord exit A
- R right hand cord exit A

Prices for Steps 1-7.

		PL07L	PL07R	PK07L	PK07R
TSPT.	20 N	\$8723	8723	8613	8613
	R	\$8979	8979	8870	8870
	T	\$9064	9064	8954	8954
	30 N	\$10347	10347	10065	10065
	R	\$10689	10689	10406	10406
	T	\$10774	10774	10491	10491

31 N	\$10378	10378	10094	10094
R	\$10719	10719	10436	10436
T	\$10803	10803	10523	10523
40 N	\$15065	15065	14528	14528
R	\$15492	15492	14955	14955
T	\$15664	15664	15125	15125
50 N	\$17677	17533	16884	16884
R	\$18188	18188	17395	17395
T	\$18359	18359	17564	17564
60 N	\$21245	21245	20038	20038
R	\$21842	21842	20636	20636
T	\$22015	22015	20808	20808

Step 8. Fabric
Price Category 2 +\$0

Tandem Sling Seating without Arms TSNA.

Eames® Tandem Sling Seating

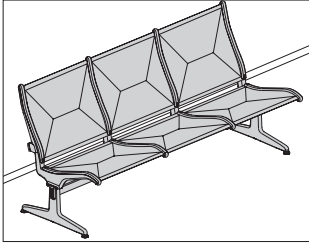

Product Information

Description

This seating product combines rows of seats in 2- to 7-unit configurations. The base is a black T-beam with polished aluminum legs and nylon glides. The sling seat is vinyl, and the arm pads are black urethane. The product can be configured with no arms or arms only at the ends of the run. Shipped assembled.

Notes

For configuration options, sequence of components is from left to right when facing unit.

For other configurations, contact Herman Miller Options.

To retrofit single-row seating to back-to-back seating, order back-to-back base connector (TS708) separately.

Dimensions

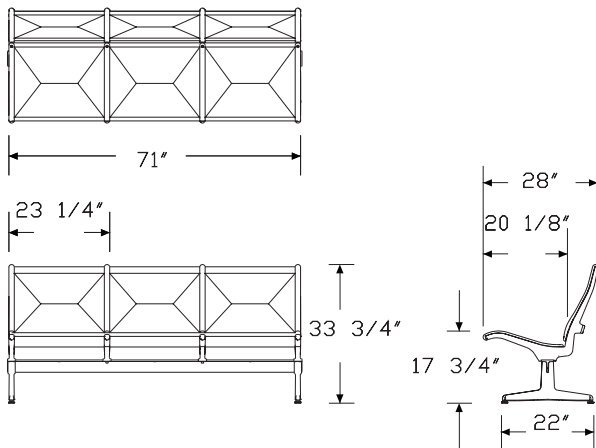

Back to Back

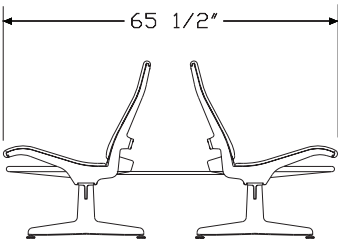

Specification Information

Step 1.

TSNA.

Step 2. Configuration

- 2EA** 2 seat unit (end of run arms)
- 3EA** 3 seat unit (end of run arms)
- 4EA** 4 seat unit (end of run arms)
- 5EA** 5 seat unit (end of run arms)
- 6EA** 6 seat unit (end of run arms)
- 7EA** 7 seat unit (end of run arms)
- 2NA** 2 seat unit no arms
- 3NA** 3 seat unit no arms
- 4NA** 4 seat unit no arms
- 5NA** 5 seat unit no arms
- 6NA** 6 seat unit no arms
- 7NA** 7 seat unit no arms

Prices for Steps 1-2.

TSNA.	2EA	\$5545
	3EA	\$7186
	4EA	\$9095
	5EA	\$10919
	6EA	\$12648
	7EA	\$14559
	2NA	\$5375
	3NA	\$7014
	4NA	\$8924
	5NA	\$10746
	6NA	\$12479
	7NA	\$14390

Step 3. Fabric

Price Category 2 +\$0

Index by Product Name

Eames® Tandem Sling Seating	
Base Connector, Back to Back	page(s) 13
Tandem Sling Seating	5
Tandem Sling Seating Pad	12
Tandem Sling Seating Power Kit	14
Tandem Sling Seating with ADA Pads	8
Tandem Sling Seating without Arms	18
Tandem Sling Seating with Powered and Nonpowered Tables	16

Index: Product Name



Index by Product Number

TS12S	Tandem Sling Seating	page(s) 5
TS12T		
TS13S		
TS13T		
TS14S		
TS14T		
TS15S		
TS15T		
TS16S		
TS16T		
TS17S		
TS17T		
TS22S		
TS22T		
TS23S		
TS23T		
TS24S		
TS24T		
TS25S		
TS25T		
TS26S		
TS26T		
TS27S		
TS27T		
TS708	Base Connector, Back to Back	13
TS900	Tandem Sling Seating Pad	12
TSA1A	Tandem Sling Seating with ADA Pads	8
TSA1B		
TSA1C		
TSA2A		
TSA2B		
TSA2C		
TSNA.	Tandem Sling Seating without Arms	18
TSPK.	Tandem Sling Seating Power Kit	14
TSPT.	Tandem Sling Seating with Powered and Nonpowered Tables	16



Index: Product Number



20-Day or Less/Assigned Lead-Time Order Information

20-Day or Less and Assigned Lead-Time Programs

20-day or less and assigned lead-time products are designed for established Herman Miller dealers with pre-approved credit.

Products are distributed from multiple manufacturing facilities across the United States. All products and options not designated by an Assigned Lead-Time icon  will ship in 20 business days or less after being acknowledged by Herman Miller. Products and options designated by an  are on the assigned lead-time program and will ship in 20 days, less than 20 days, or more than 20 days from order acknowledgement.

Ordering Procedure

Please place orders through Order Manager. If this is not available to you, place orders through mail or fax. Verbal purchase orders will not be accepted.

Order Entry fax number for Meridian®

Filing and Storage: (616) 846 9236.

Order Entry fax number for all other products:

(616) 654 3085.

For more information, contact your Customer Care representative at:
(866) 854 3048 ext 3400.

Shipments and Delivery

Per Herman Miller Terms and Conditions.

Changes and Cancellation

Per Herman Miller Terms and Conditions.



Textiles Application Chart – Seating

• Available

[A] Assigned lead-time textile.

[A] Maharam textiles are on assigned lead times.

[N] Non-woven textile.

See below for exception notes.

Price Category 1

	Aeron® Chairs	Asari Work Chairs by Herman Miller™	Cosm™ Chairs	Mirra® 2 Chairs/Stools	Embody® Chairs	Fluid Nesting Chairs	Sayl® Work Chairs/Stools	Sayl Side Chairs	Setu® Chairs/Stools	Zeph® Chairs	Verus™ Work Chairs/Stools Back	Verus Work Chairs/Stools Seat	Verus Side Chairs Back	Verus Side Chairs Seat	Verus Plus Chairs	Aside® Chairs	Caper® Chairs/Stools	Lino™ Chairs Back	Lino Chairs Seat	OE1 Storage Trolley Cushion Top	Plex® Lounge Furniture	Swoop™ Lounge Seating - Fully Upholstered	Swoop Lounge Seating - Plywood	Valor™ Seating	Eames® Tandem Sling Seating	Cushion Tops	Workspaces	
COM Customer's Own Material [A]							1	1			1	1	1	1	1	1				1	1	1	1	1	1	1	1	1
231__ 8Z Pellicle®	•																											
1A7__ AireWeave™ 2				•																								
8T__ Crossing									•							•					•		•			•	•	
3DE__ Dex							•	•	•		•	•	•	•	•	•				•	19	•		•		•	•	
4RM__ Duo																		•										
6V__ Flexnet™																	•											
845__ Intercept			•																									
365__ Interweave 2											•		•															
4W__ Lyriss 2™									•																			
1MN__ Monologue							24	22	•			•	•	•					•	•	•	•	•	•	•	•	•	
5H2__ Ripple 3D Knit										•																		
5H1__ Splash 3D Knit										•																		
4SC__ Scatter							•	•	•		•	•	•	•	•	•			•	•	•	•	•	•	•	•	•	
3DN__ Scribe							25	22	•		•		•	•	•				•	•				•		•	•	
3DK__ Stretch Knit [A]							25																					
235__ Tailored							•	•	•		•	•	•	•	•	•			•		23		•		7	•		
9NK__ Tuck 3D Knit					•																							
1WS__ Whisper							24	•	•		•	•	•	•	•	•			•	•	•	•	•	•	•	•	•	

Price Category 2

3AR__ Aristo							•	•	•		•	•	•	•	•	•			•	•	•	•	•	•	•	•	•	
92__ Crepe							•	•	•		•	•	•	•	•	•			•	•	•	•	•	•	•	•	•	
3EP__ Epic							•	•			•	•	•	•	•	•			•		•		•		7	•	•	
3DP__ Hint							•	•			•	•	•	•	•	•			•				•	•	•	•	•	
1MV__ Marvel [N]							25	22	•										•				•	•	•	•	•	
1HA__ Medley				•			•	22			•	•	•	•	•	•			•	•	•	•	•	•	•	•	•	
4ME__ Mellow							•	22			•	•	•	•	•	•			•	•		•	•	•	•	•	•	
ZMA__ Metaphor - Maharam [A]							16	16	•		•		•	•	•	•			•		•	•	•	•	•	•	•	
8I1__ Muse - Maharam [A]							16	16			•		•						•					26		•	•	
30__ Rhythm					23		•	•			•	•	•	•	•	•			•	•		•	•	•	•	•	•	
3SL__ Sequel [N]							27	27	27		27	27	27	27	27	8			27	•	•	•	•	•	•	23	•	•
4TE__ Terra							•	22			•	•	•	•	•	•			•			•	•	•	•	•	7	•
8R__ Twist							•	•	•		•	•	•	•	•	•			•	•	•	•	•	•	•	•	•	

Price Category 3

3AC__ Ace							25	•			•	•	•	•	•	8			•	•	19		•		•	•	•
43Z__ Fractal							•	•	•		•	•	•	•	•	•			•		•	•	•	•	•	•	•
8M__ Latitude™						23																					
ZM2__ Meld - Maharam * [A]		•					•	•	•		•	•	•	•	•	•			•	•	•	•		•	•	•	•
4GE__ Parcel							•	•	•		•	•	•	•	•	•			•		•	•	•	•	•	•	•

Price Category 4

3DM__ Daydream							25	•	•		•		•	•	•	•			•	•	•	•	•		•	•	•
ZLR__ Lariat - Maharam [N] [A]							•	•	•		•	•	•	•	•	•			•		20		•		•	•	•
3SY__ Sync				•			•	•	•		•	•	•	•	•	•			•		•	•	•	•	•	•	•

continued on next page

Textiles Application Chart — Seating continued

• Available

[A] Assigned lead-time textile.

[A] Maharam textiles are on assigned lead times.

[N] Non-woven textile.

See below for exception notes.

	Aeron® Chairs	Asari Work Chairs by Herman Miller™	Cosm™ Chairs	Mirra® 2 Chairs/Stools	Embody® Chairs	Fuld Nesting Chairs	Say® Work Chairs/Stools	Say Side Chairs	Setu® Chairs/Stools	Zeph® Chairs	Verus™ Work Chairs/Stools Back	Verus Work Chairs/Stools Seat	Verus Side Chairs Back	Verus Side Chairs Seat	Verus Plus Chairs	Aside® Chairs	Caper® Chairs/Stools	Lino™ Chairs Back	Lino Chairs Seat	OE1 Storage Trolley Cushion Top	Plex® Lounge Furniture	Swoop™ Lounge Seating - Fully Upholstered	Swoop Lounge Seating - Plywood	Valor™ Seating	Eames® Tandem Sling Seating	Cushion Tops	Workspaces	
Price Category 5																												
5YT__Arlo - Maharam [A]																												
3CY__Cozy																												
14A__Hopsak																												
40G__Method - Maharam [A]							16	16																				
ZNC__Nico - Maharam [A]																												
3SU__Summit [N]																												
Price Category 6																												
35__ Balance																												
Price Category 7																												
COL Customer's Own Leather [A]		1														8				1							1	
ZB3__Beck - Maharam [A]							16	16																				
8PV__Mantle - Maharam [A]							16	16																				
5K3__Rowan - Maharam [A]							16	16																				
Price Category 8																												
ZLU__Luce - Maharam [A]							16	16																				
Price Category 9																												
ZC0__Campana - Maharam [A]							16	16																				
ZGE__Gemma - Maharam [A]																												
ZJA__Jasper - Maharam [A]							16	16																				7
Z1__Leather [N]		23													8													
Price Category 10																												
3KH__Firma - Maharam [A]							16																					
ZGF__Gemma Multi - Maharam [A]																												
ZGF__Gemma Multi Reverse - Maharam [A]																												
ZP4__Petra - Maharam [A]							16	16																				
Price Category 11																												
3BS__Felix - Maharam [A]							16	16																				
Price Category A																												
No fabrics available at this time.																												
Price Category B																												
VM__Medium - Maharam [A]																												
TI__Messenger - Maharam * [A]																											26	
Price Category C																												
Z27__Manner - Maharam [A]																												
887__Merit - Maharam [A]																												
Z3__Metric - Maharam [A]																												
8EY__Murmur - Maharam [A]								16																				7
Price Category D																												
8I8__Bluff - Maharam [N] [A]							16	16							8						21							
ZMD__Mode - Maharam [A]							18																					
Price Category E																												
ZAT__Article - Maharam [N] [A]							16	16																				7

continued on next page

Textiles Application Chart – Seating continued

• Available

[A] Assigned lead-time textile.

[A] Maharam textiles are on assigned lead times.

[N] Non-woven textile.

See below for exception notes.

	Aeron® Chairs	Asari Work Chairs by Herman Miller™	Cosm™ Chairs	Mirra® 2 Chairs/Stools	Embody® Chairs	Fluid Nesting Chairs	Sayl® Work Chairs/Stools	Sayl Side Chairs	Setu® Chairs/Stools	Zeph® Chairs	Verus™ Work Chairs/Stools Back	Verus Work Chairs/Stools Seat	Verus Side Chairs Back	Verus Side Chairs Seat	Verus Plus Chairs	Aside® Chairs	Caper® Chairs/Stools	Lino™ Chairs Back	Lino Chairs Seat	OE1 Storage Trolley Cushion Top	Plex® Lounge Furniture	Swoop™ Lounge Seating - Fully Upholstered	Swoop Lounge Seating - Plywood	Valor™ Seating	Eames® Tandem Sling Seating	Cushion Tops	Workspaces
Price Category F																											
82T__Apt - Maharam [N] [A]							18	•					•	•													7
871__Brindle - Maharam [A]							16	16				•		•					•	•					•		•
87Z__Conduit - Maharam [A]							16	16			•	•	•	•					•								7
74M__Instill - Maharam [N] [A]							18	16			•	•	•	•					•		•		•	•			7
89N__Keen - Maharam [A]							16	16				•		•	•				•		•	•	•				
V9G__Ledger - Maharam [N] [A]							18	16			•	•	•	•	•				•	•		•	•		•		•
ZLL__Loop - Maharam [A]							16	16				•		•			8		•						•		
82A__Multiply - Maharam [A]							16	16			•	•	•	•					•					•	•	•	
8LW__Pepper - Maharam [A]							16	16				•		•					•		21	•		9			•
Z33__Strum - Maharam [N] [A]							16															•		•			7
Price Category G																											
ZC2__Compound - Maharam [N] [A]							16	16			•	•	•	•		8			•		•		•	•			7
ZF1__Fold - Maharam [N] [A]							16	16																	•		7
8AR__Gild - Maharam [A]							16					•	•	•	•						21	•	•	•	•		
ZPR__Pare - Maharam [A]							18	16				•		•		8			•		•	•	•				7
ZRF__Runner - Maharam [A]							16	16												•				•		•	
Price Category H																											
ZT__Circles - Maharam [A]							16	16																			•
ZK__Dot Pattern - Maharam [A]							•	•	•			•		•						•				•		•	•
ZL__Small Dot Pattern - Maharam [A]							•	•	•			•		•						•				•		•	•
Price Category I																											
7CW__Cursive - Maharam [A]							16	16			•	•	•	•		8			•	•		•		•			•
ZSY__Study - Maharam [A]																				•				•			
Price Category J-K																											
No fabrics available at this time.																											
Price Category L																											
ZMK__Minicheck - Maharam [A]							•	•			•	•	•		•				•					•			7
Price Category M																											
ZF2__Fruit - Maharam [A]							16								•												7
Price Category N-Q																											
No fabrics available at this time.																											
Price Category R																											
Stow Leather											•																
Price Category S-Z																											
No fabrics available at this time.																											

continued on next page

Textiles Application Chart — Seating continued

- Available

[A] Assigned lead-time textile.

[A] Maharam textiles are on assigned lead times.

[N] Non-woven textile.

See below for exception notes.

Application Note: Herman Miller cannot guarantee material/pattern alignment in adjacent products. For example, a fabric's pattern may not align from one pedestal cushion top to the next, or from one chair to another.

** Available in select colors on 20-day lead-time. Refer to "Maharam Colors - Seating" for 20-day colors.*

- | | | | |
|----|--|----|---|
| 1 | Refer to price book appendices and Omni for COM/COL information. | 22 | Not available on Sayl side chairs with upholstered backs. |
| 7 | Available on 1" Cushion Tops only. | 23 | Available in select colors. Refer to "Textile Colors" for color offering. |
| 8 | Only available on the Aside nonupholstered outer back option (PB). | 24 | Not available on Sayl upholstered High-Back Work Chairs. |
| 9 | Available on Valor upholstered seat only. | 25 | Not available on Sayl upholstered back work chairs. |
| 16 | Available on Sayl Chair seat. | 26 | Available in select colors. Refer to "Textile Colors" for color offering. |
| 18 | Available on Sayl Chair seat and upholstered mid-back. | 27 | Not available in 3SL15 Carbon Dark. |
| 19 | Available on Sayl seat only. | | |
| 20 | Not available on Plex Club Chair with Headrest. | | |
| 21 | Available on Plex seat and on Ottoman. | | |

Textile Colors

Price Category 1

Customer's Own Material
See Order Information in Appendices. Assigned lead-time textile. [A](#)

8Z Pellicle®
Seating
For New Aeron® Chairs
56% elastomeric
44% polyester
23101 Mineral
23102 Carbon
23103 Graphite

AireWeave™ 2
Seating
For Mirra® 2 Chairs
67% elastomeric
33% antimony-free polyester
1A701 Alpine
1A702 Slate Grey
1A703 Graphite
1A704 Lime Green
1A705 Cappuccino
1A706 Urban Orange
1A707 Dark Turquoise
1A708 Twilight

Chain
Workspaces
66" wide
100% recycled polyester with 12% ocean bound plastic
2V01 Pearl
2V02 Oyster
2V03 Wheat
2V04 Linen
2V05 Wicker
2V06 Bamboo
2V07 Sage
2V08 Spring Wood
2V09 Iceberg

Crossing
Seating/Workspaces
54" wide
86% antimony-free polyester
14% polyester
8T03 Wicker *
8T04 Porcelain *
8T05 Warm Grey *
8T10 Tomato
8T17 Cerulean
8T18 Indigo
8T19 Shale *
8T22 Tin *
8T23 Graphite
8T24 Black

Crossing
Workspaces
For workspaces products only.
54" wide
86% antimony-free polyester
14% polyester
8501 Ivory *
8502 Oyster *
* Colors available on Exclave®
Video-friendly Tackable Boards and Stowage Tackable Backdrop

Dex
Ancillary/Seating/Workspaces
54" wide
67% recycled polyester
33% polyester
3DE01 Frost
3DE02 Silver Pine
3DE03 Stone
3DE04 Shale
3DE05 Charcoal
3DE06 Gossamer
3DE07 Pine

Duo
Seating
For Lino™ Chairs
52% polyester
48% elastomeric
4RM01 Mineral
4RM02 Poppy
4RM03 Green Leaf
4RM04 Jade
4RM05 Shadow
4RM06 Graphite

Flexnet™
Seating
For Caper® Chairs
69% elastomeric
31% polyester
6V01 Black
6V02 Silver Grey

Grasscloth
Workspaces
66" wide
100% recycled polyester with 11% ocean bound plastic
2I01 Silver Birch
2I02 Pampas
2I03 Sedge
2I07 Lea
2I08 Taro
2I09 Steam Grey
2I13 Gravel

Intercept
Seating
For Cosm™ Chairs
60% elastomeric
40% polyester
84501 Graphite
84502 Carbon
84503 Mineral
84504 Nightfall
84505 Glacier
84506 Canyon

Interweave 2
Seating
For Verus™ Chairs
65% elastomeric
35% polyester
36501 Iceberg
36502 Poppy
36503 Beachglass
36504 Blue Grotto
36505 Slate
36506 Shale

Lyris 2™
Seating
For Setu® Chairs
74% elastomeric
26% polyester
4W21 Alpine
4W23 Chartreuse
4W25 Berry Blue
4W26 Slate Grey
4W28 Chino
4W31 Graphite

Monologue
Ancillary/Seating/Workspaces
54" wide
56% recycled polyester
44% polyester
1MN01 Linen
1MN02 Alabaster
1MN04 Folkstone
1MN05 Silver Pine
1MN06 Slate
1MN07 Seed
1MN09 Persimmon
1MN11 Meadow
1MN12 Blue Sky
1MN13 Blue Spruce
1MN14 Deep Sea

Price category 1 continued on next page

- Maharam textiles are on assigned lead times [A](#).
- Fabric numbers are listed as Herman Miller fabric number/Maharam fabric number.

Textile Colors

continued

Price Category 1

continued

Appendix: Textile Colors

Resonance	
Workspaces	
66" wide	
100% polyester	
5T04	Greige
5T05	Porcelain
5T06	Alabaster
5T15	Iris
5T28	Sugar
5T47	Tobacco
5T54	Saltbush
5T57	Seed
5T58	Sepia
5T60	Iceberg
5T65	Red
5T67	Boysenberry
5T68	Pistachio
5T69	Green Apple
5T71	Jade
5T72	Blue Green
5T74	Twilight

Ripple 3D Knit	
Seating	
Available only on Zeph® Chairs.	
knit to size	
99% recycled polyester	
1% lycra	
5H201	Black
5H202	Carbon
5H203	Alpine
5H204	Silt
5H205	Tea Rose
5H206	Cocoa
5H207	Persimmon
5H208	Blaze
5H209	Cayenne
5H210	Falcon
5H211	Mustard Seed
5H212	Patina
5H213	Olive
5H214	Moss
5H215	Aloe
5H216	Glacier
5H217	Ultramarine
5H218	Nightfall
5H219	Bluebell
5H220	Boysenberry
5H221	Nightfall/Bluebell
5H222	Patina/Alpine
5H223	Cayenne/Glacier
5H224	Tea Rose/Olive
5H225	Silt/Blaze

Scatter	
Ancillary/Seating/Workspaces	
54" wide	
100% recycled polyester, with 26% ocean bound plastic	
4SC01	Alpine
4SC02	Fog
4SC03	Shale
4SC04	Persimmon
4SC07	Olive
4SC08	Glacier
4SC09	Blue Sky
4SC10	Lagoon
4SC11	Slate Grey
4SC12	Blue Black

Scribe	
Seating/Workspaces	
54" wide	
100% recycled polyester with 53% ocean bound plastic	
3DN01	Spring Wood
3DN02	Poplar
3DN03	Pewter
3DN04	Deep Sea
3DN05	Fir
3DN06	Nutmeg

Slant	
Workspaces	
66" wide	
51% polyester 49% recycled polyester	
22F04	Pesto
22F06	Neptune
22F07	Blueberry
22F10	Pumpkin
22F12	Silver Birch
22F13	Bluestone
22F15	Shale

Splash 3D Knit	
Seating	
Available only on Zeph® Chairs.	
knit to size	
98% recycled polyester	
2% lycra	
5H101	Black
5H102	Carbon
5H103	Alpine
5H104	Silt
5H105	Tea Rose
5H106	Cocoa
5H107	Persimmon
5H108	Blaze
5H109	Cayenne
5H110	Falcon
5H111	Mustard Seed
5H112	Patina
5H113	Olive
5H114	Moss
5H115	Aloe
5H116	Glacier
5H117	Ultramarine
5H118	Nightfall
5H119	Bluebell
5H120	Boysenberry

Stretch Knit	
Seating	
Assigned lead-time textile. ^A	
Available only on Say®	
Suspension Back Work Chairs	
97% polyester, 3% spandex	
3DK01	Fog
3DK02	Slate Grey
3DK03	Java
3DK04	Black
3DK05	Red
3DK06	Green Apple
3DK07	Berry Blue

Price category 1 continued on next page

- Maharam textiles are on assigned lead times ^A.
- Fabric numbers are listed as Herman Miller fabric number/Maharam fabric number.

Textile Colors

continued

Price Category 1

continued

Tailored

Ancillary/Seating/Workspaces
54" wide

56% polyester
44% recycled polyester

23501	Studio White * **
23502	Sugar *
23503	Tomato
23506	Chive
23508	Cobalt
23509	Cadet
23510	Fog
23511	Graphite
23512	Black
23513	Coffee

* Colors not available on
Plex™ Lounge Furniture.

** Color not available on Canvas
Tiles.

Tuck 3D Knit

Seating
Available only on Fuld Nesting
Chairs.

knit to size
56% polyester
44% recycled polyester

9NK01	Alpine
9NK02	Carbon
9NK03	Nightfall
9NK04	Olive
9NK05	Cocoa
9NK06	Canyon

Whisper

Ancillary/Seating/Workspaces
54" wide

73% recycled polyester
27% polyester
with 11.3% ocean bound plastic

1WS01	Sand Dollar
1WS02	Pebble
1WS03	Silver Birch
1WS04	Iceberg
1WS05	Silver Pine
1WS06	Carbon
1WS07	Cumin
1WS12	Willow
1WS13	Sea Grass
1WS14	Pool
1WS15	Blueberry
1WS16	Glacier
1WS17	Grey
1WS18	Canyon

Price Category 2

Aristo

Ancillary/Seating/Workspaces
54" wide

88% recycled polyester
12% polyester
Acrylic backing

3AR01	Forest Moss
3AR02	Light Brindle
3AR03	Mink
3AR04	Copper
3AR05	Adobe
3AR06	Cherry
3AR07	Lilac
3AR08	Green Apple
3AR09	Surf
3AR10	Waterfall
3AR11	Cadet
3AR12	Tin
3AR13	Pewter
3AR14	Grey Brindle
3AR15	Grey Black

Cord

Workspaces
66" wide
51% antimony-free polyester
49% polyester

5101	Ivory
5102	White Ash
5103	Linen
5104	Bamboo
5105	Sepia
5107	Sesame
5109	Bayou
5111	Spring Wood
5112	Summer White

Crepe

Ancillary/Seating/Workspaces
54" wide

100% recycled polyester,
with 43.6% ocean bound plastic

9201	Licorice
9203	Smoke
9207	Cherry
9223	Cadet
9241	Beachglass
9249	Stone *
9251	Fog *
9252	Slate Grey
9261	Shale
9262	Graphite
9265	Mineral
9266	Persimmon
9267	Juniper
9268	Glacier
9269	Cascade
9270	Navy

* Colors available on Exclave®
Video-friendly Tackable Boards and
Stowage Tackable Backdrop.

Price category 2 continued on
next page

- Maharam textiles are on assigned lead times ^A.
- Fabric numbers are listed as Herman Miller fabric number/Maharam fabric number.

Textile Colors

continued

Price Category 2

continued

Appendix: Textile Colors

Epic	
Ancillary/Seating/Workspaces	
54" wide	
56% recycled polyester	
44% polyester	
Acrylic backing	
3EP01	Alabaster
3EP02	Smoke
3EP03	Falcon
3EP05	Copper
3EP06	Urban Orange
3EP07	Poppy
3EP10	Clover
3EP11	Loden
3EP14	Peacock
3EP15	Cadet
3EP16	Indigo
3EP17	Spring Wood
3EP18	Grey Brindle
3EP19	Seed
3EP20	Carbon Dark
Hint	
Ancillary/Seating/Workspaces	
54" wide	
76% recycled polyester	
24% polyester	
3DP01	Sediment
3DP02	Gunmetal
3DP03	Silt
3DP04	Porcelain
3DP05	Indigo
3DP06	Fern
3DP07	Adobe
3DP08	Red Sea

Horizon	
Workspaces	
54" wide	
65% antimony-free polyester	
35% polyester	
4N01	Rye Grass
4N02	Sugar Pine
4N03	Silver Pine
4N04	White Ash
4N05	Spring Wood
4N08	Haystack
4N09	Oat Grass
4N13	Pine Cone
4N15	Elderberry

Marvel	
Ancillary/Seating	
54" wide	
100% pvc-free polyurethane	
antimicrobial, antibacterial finish	
1MV01	Summer White
1MV02	Sand Dollar
1MV03	Espresso
1MV04	Folkstone Grey
1MV05	Graphite
1MV06	Onyx
1MV07	Polar Blue
1MV08	Blush Grey
1MV12	Red
1MV14	Pine
1MV15	Teal Green
1MV16	Twilight

Medley	
Ancillary/Seating/Workspaces	
54" wide	
100% polyester	
1HA01	Stone *
1HA02	Trail
1HA03	Charcoal
1HA04	Cinder
1HA07	Chutney
1HA09	Feather Grey *
1HA11	Loden
1HA13	Bayou *
1HA14	Blue Grotto
1HA15	Blueberry
1HA22	Khaki
1HA23	Pewter
1HA24	Yellow Oxide
1HA25	Vintage Rose
1HA26	Raspberry
1HA27	Acai Berry

* Colors available on Exclave®
Video-friendly Tackable Boards
and Stowage Tackable Backdrop

Mellow	
Ancillary/Seating/Workspaces	
54" wide	
100% recycled polyester, with 16% ocean bound plastic	
4ME01	Mineral
4ME04	Olive
4ME05	Glacier
4ME06	Oceanside
4ME07	Charcoal

Metaphor – Maharam	
Ancillary/Seating/Workspaces	
54" wide	
100% polyester	
Acrylic backing	
ZMA01/466553-001	Afterfeather *
ZMA02/466553-002	Moonflower
ZMA03/466553-003	Handcraft
ZMA04/466553-004	Crossroad
ZMA05/466553-005	Chondrite
ZMA06/466553-006	Detective
ZMA07/466553-007	Steamship
ZMA08/466553-008	Electricity
ZMA09/466553-009	Takeoff
ZMA10/466553-010	Parachute
ZMA11/466553-011	Blueshift
ZMA12/466553-012	Dockyard
ZMA13/466553-013	Bathe
ZMA14/466553-014	Icebound
ZMA15/466553-015	Thermosphere
ZMA16/466553-016	Aboard
ZMA17/466553-017	Agaware
ZMA18/466553-018	Homeland
ZMA19/466553-019	Rockfall
ZMA20/466553-020	Undergrowth
ZMA21/466553-021	Gremolata
ZMA22/466553-022	Patina
ZMA23/466553-023	Sylvan
ZMA24/466553-024	Outfield
ZMA25/466553-025	Windbreak
ZMA26/466553-026	Saguaro

Price category 2 continued on
next page

- Maharam textiles are on assigned lead times [A](#).
- Fabric numbers are listed as Herman Miller fabric number/Maharam fabric number.

Textile Colors

continued

Price Category 2

continued

Metaphor continued

ZMA27/466553-027	Barnwood
ZMA28/466553-028	Cookshop
ZMA29/466553-029	Amandine
ZMA30/466553-030	Bodhran
ZMA31/466553-031	Centerstage
ZMA32/466553-032	Focaccia
ZMA33/466553-033	Bumblebee
ZMA34/466553-034	Microbrew
ZMA35/466553-035	Sauna
ZMA36/466553-036	Gazebo
ZMA37/466553-037	Pirouette
ZMA38/466553-038	Heartbeat
ZMA39/466553-039	Shino
ZMA40/466553-040	Sunrise
ZMA41/466553-041	Florist
ZMA42/466553-042	Beadwork
ZMA43/466553-043	Framboise
ZMA44/466553-044	Wisteria
ZMA45/466553-045	Warrior

* Colors not available on Eames Aluminum Group, Soft Pad, Sofa Compact, Molded Fiberglass/Plastic Chairs, Task Chair, Wire Chairs, Nelson Platform Bench Cushion, Swoop Plywood Lounge Chair.

Muse – Maharam

Ancillary/Seating/Workspaces	
54" wide	
100% post-consumer recycled polyester	
8I101/466487-001	Crescendo
8I102/466487-002	Resonate
8I103/466487-003	Runway
8I104/466487-004	Ascend
8I105/466487-005	Veil *
8I106/466487-006	Refresh *
8I107/466487-007	Clear *
8I108/466487-008	Fantasy
8I109/466487-009	Miso
8I110/466487-010	Compass
8I111/466487-011	Bergamot *
8I112/466487-012	Grasshopper

Muse continued

8I113/466487-013	Goal
8I114/466487-014	Mistletoe
8I115/466487-015	Seaglass *
8I116/466487-016	Frigid
8I117/466487-017	Riverbend
8I118/466487-018	Noble
8I119/466487-019	Pulsar
8I120/466487-020	Velella
8I121/466487-021	Sailboat
8I122/466487-022	Sparse
8I123/466487-023	Vase
8I124/466487-024	Haven
8I125/466487-025	Mead
8I126/466487-026	Neat
8I127/466487-027	Jovial
8I128/466487-028	Theater
8I129/466487-029	Poinsettia
8I130/466487-030	Celebrate
8I131/466487-031	Spectacle

* Colors not available on Valor Seating.

Rhythm

Ancillary/Seating	
54" wide	
100% polyester	
3002	Green Apple
3004	Bayou
3005	Berry Blue
3006	Iris
3007	Twilight
3009	Poppy
3010	Molasses
3012	Khaki
3013	Mink
3014	Black *
3015	Charcoal *

* Colors available on Embody® Chair.

Sequel

Ancillary/Seating/Workspaces	
54" wide	
100% vinyl	
100% polyester knit backing	
Resilience® finish	
3SL01	White
3SL02	Pebble
3SL03	Mushroom
3SL04	Stone
3SL06	Rattan
3SL09	Seal
3SL10	Blue Fog
3SL11	Folkstone
3SL12	Shale
3SL13	Slate Grey
3SL14	Charcoal
3SL15	Carbon Dark
3SL28	Navy *

* Color available on Eames® Tandem Sling Seating.

Terra

Ancillary/Seating/Workspaces	
54" wide	
100% post-consumer recycled biodegradable polyester *	
4TE01	Spring Wood
4TE02	Zinc
4TE03	Pine Cone
4TE04	Charcoal

* 1% biodegradation in 1,278 days under ASTM D5511 conditions. No evidence of further degradation.

Twine

Workspaces	
66" wide	
100% recycled polyester	
3TW01	Silver Birch
3TW02	Ivory
3TW03	Alabaster
3TW04	Bamboo
3TW05	Iceberg
3TW06	Charcoal
3TW07	Feather Grey
3TW08	Shale

Twist

Ancillary/Seating/Workspaces	
54" wide	
80% antimony-free polyester	
13% recycled polyester	
7% polyester	
8R05	Wicker
8R10	Poppy
8R14	Tin
8R15	Shale
8R16	Graphite
8R17	Birch
8R18	Sepia
8R22	Blueberry
8R23	Green Apple
8R26	Gunmetal
8R27	Cinder
8R29	Pekoe
8R33	Forest
8R35	Waterfall
8R36	Midnight Blue
8R37	Carbon Dark

Twist

Workspaces	
For workspaces products only.	
54" wide	
80% antimony-free polyester	
13% recycled polyester	
7% polyester	
5S03	Oyster

- Maharam textiles are on assigned lead times [A](#).
- Fabric numbers are listed as Herman Miller fabric number/Maharam fabric number.

Textile Colors

continued

Price Category 3

Appendix: Textile Colors

Ace	
Ancillary/Seating	
54" wide	
100% polyurethane	
Polyester knit backing	
Stain resistant finish	
3AC01	Summer White
3AC02	White Ash
3AC03	Rye
3AC04	Metal
3AC05	Clay
3AC06	Chestnut
3AC08	Camelback
3AC09	Chipotle
3AC12	Artichoke
3AC13	Sepia Dark
3AC14	Aloe
3AC15	Flint
3AC16	Blue Sky
3AC17	Oceanside
3AC18	Midnight
3AC20	Frost
3AC21	Lead
3AC22	Black

Fractal	
Ancillary/Seating/Workspaces	
58" wide	
84% recycled polyester	
16% polyester	
43Z01	Granite
43Z02	Golden Olive
43Z03	Verdant
43Z04	Cadet

Ground Cloth®	
Workspaces	
66" wide	
100% polyester	
4701	Vapor Grey
4721	Warm White *
4722	Fog *
4723	Straw *
4724	Red Orange *
4726	Green Apple *
4727	Caribbean *
4728	Midnight *
4729	Cappuccino *

* Colors available on Exclave®
Video-friendly Tackable Boards
and Stowage Tackable Backdrop

Latitude	
Seating	
Colors for Mirra 2 Chairs	
100% polyester	
8M10	Alpine
8M17	Black
8M23	French Press
8M27	Cordovan
8M28	Ochre
8M28	Ultramarine
8M28	Olive

Meld – Maharam	
Ancillary/Seating/Workspaces	
54" wide	
68% post-consumer recycled polyester	
32% polyester	
PFOA-Free stain resistant	
ZM201/466387-201	Vast
ZM202/466387-202	Panda **
ZM203/466387-203	Skyline *
ZM204/466387-204	Knight **
ZM205/466387-205	Quill **
ZM206/466387-206	Pipe
ZM207/466387-207	Grate *
ZM208/466387-208	Gloss

Meld continued	
ZM209/466387-209	Bulb
ZM210/466387-210	Bride
ZM211/466387-211	Stark
ZM212/466387-212	Seashell
ZM213/466387-213	Antler
ZM214/466387-214	Crater *
ZM215/466387-215	Perennial
ZM216/466387-216	Mulberry
ZM217/466387-217	Fuchsia *
ZM218/466387-218	Amethyst *
ZM219/466387-219	Merlot
ZM220/466387-220	Magma *
ZM221/466387-221	Rooster
ZM222/466387-222	Heat *
ZM223/466387-223	Clementine
ZM224/466387-224	Fox
ZM225/466387-225	Kiss *
ZM226/466387-226	Bare
ZM227/466387-227	Blonde
ZM228/466387-228	Mimosa
ZM229/466387-229	Comet *
ZM230/466387-230	Honeydew
ZM231/466387-231	Wild *
ZM232/466387-232	Vine
ZM233/466387-233	Seed
ZM234/466387-234	Kale *
ZM235/466387-235	Waterfall *
ZM236/466387-236	Nordic *
ZM237/466387-237	Reef *
ZM238/466387-238	Wave
ZM239/466387-239	Isle **
ZM240/466387-240	Creek
ZM241/466387-241	Mariner *
ZM242/466387-242	Globe
ZM243/466387-243	Spa

* Colors available on
20-day lead time.

** Colors available on
10-day lead time.

Parcel	
Ancillary/Seating/Workspaces	
54" wide	
100% recycled polyester	
4GE01	Gunmetal
4GE02	Brindle
4GE03	Bayou
4GE04	Pesto
4GE05	Golden Olive
4GE06	Copper Sea

Saille - Geiger Textile	
Ancillary	
57" wide	
69% cotton	
31% polyester	
PFOA-Free stain resistant finish	
Acrylic backing	
18001	Coal
18002	Shale
18003	Haze
18004	Stone
18005	White *
18006	Beach
18007	Sand
18008	Blush
18009	Brick
18010	Fog
18011	Celadon
18012	Poolside
18013	Summer Sky
18014	Lake
18015	Midnight Blue

* Color not available on Eames®
Soft Pad Group Chairs/Ottomans.

Price category 3 continued on
next page

- Maharam textiles are on assigned lead times [A](#).
- Fabric numbers are listed as Herman Miller fabric number/Maharam fabric number.

Textile Colors

continued

Price Category 3

continued

Strands	
Workspaces	
66" wide	
100% recycled polyester	
8W01	Pebble
8W02	Porcelain
8W03	Taupe
8W04	Honey
8W05	Khaki
8W06	Rye
8W07	Wicker
8W08	Tin
8W09	Cool Grey

Price Category 4

Cygnus	
Ancillary	
For Eames® Aluminum Group Chairs	
69% elastomeric	
31% polyester	
5401	Black
5402	Zinc
5403	Quartz

Daydream	
Ancillary/Seating/Workspaces	
54" wide	
48% wool	
41% recycled polyester	
9% nylon	
2% polyester	
3DM01	Rye Grass
3DM02	Silver Birch
3DM03	Pewter
3DM04	Graphite
3DM05	Black
3DM06	Lemongrass
3DM07	Permission
3DM08	Juniper
3DM09	Sea Grass
3DM10	Nightfall

Hush	
Workspaces	
66" wide	
80% polyester	
20% viscose	
1HS01	Canyon
1HS02	Pesto
1HS03	Bayou
1HS04	Greystone
1HS05	Charcoal
1HS06	Rye Grass
1HS07	Cool Grey
1HS08	Dark Grey
1HS09	Aqua Green
1HS10	Nightfall

Kalista - Geiger Textile	
Ancillary	
54" wide	
71% post-industrial recycled cotton	
18% post-industrial recycled polyester	
11% polyester	
PFOA-Free stain resistant finish	
1AL01	Cotton
1AL02	Natural
1AL03	Titanium
1AL04	Pewter
1AL05	Starry Night
1AL06	Red Hot
1AL07	Sun Kissed
1AL08	Dune
1AL09	Beach Glass
1AL10	Bluestone
1AL11	Seaside
1AL12	Night Sky

Lariat - Maharam	
Ancillary/Seating	
54" wide	
100% vinyl	
ZLR01/440401-001	001
ZLR02/440401-002	002
ZLR04/440401-004	004
ZLR06/440401-006	006
ZLR07/440401-007	007
ZLR08/440401-008	008
ZLR10/440401-010	010
ZLR11/440401-011	011
ZLR13/440401-013	013
ZLR14/440401-014	014
ZLR15/440401-015	015
ZLR16/440401-016	016
ZLR18/440401-018	018
ZLR20/440401-020	020
ZLR21/440401-021	021
ZLR24/440401-024	024
ZLR25/440401-025	025
ZLR26/440401-026	026

Lariat continued	
ZLR28/440401-028	028
ZLR31/440401-031	031
ZLR32/440401-032	032
ZLR33/440401-033	033
ZLR34/440401-034	034
ZLR38/440401-038	038
ZLR39/440401-039	Granite
ZLR40/440401-040	Linen
ZLR41/440401-041	Stella
ZLR42/440401-042	Saddle
ZLR43/440401-043	Holly
ZLR44/440401-044	Maroon
ZLR45/440401-045	Siren
ZLR46/440401-046	Reseda
ZLR47/440401-047	Purslane
ZLR48/440401-048	Spire
ZLR49/440401-049	Papyrus
ZLR50/440401-050	Chickadee
ZLR51/440401-051	Requiem

Sync	
Ancillary/Seating	
55" wide	
100% polyester	
3SY01	Pine Cone
3SY03	Canyon
3SY04	Truffle
3SY06	Everglade
3SY08	Nightfall
3SY09	Dark Mineral
3SY10	Slate Grey
3SY11	Dark Carbon
3SY12	Black

Appendix: Textile Colors

- Maharam textiles are on assigned lead times [A](#).
- Fabric numbers are listed as Herman Miller fabric number/Maharam fabric number.

Textile Colors

continued

Price Category 5

Appendix: Textile Colors

Arlo - Maharam		Hopsak		Method - Maharam		Nico - Maharam	
Ancillary/Seating		Ancillary/Seating/Workspaces		Ancillary/Seating/Workspaces		Ancillary/Seating/Workspaces	
70% wool		56" wide		54" wide		54" wide	
30% polyester		100% recycled polyester		100% recycled polyester		63% wool	
				with 9% ocean-bound plastic		21% polyester	
5YT01	Turn	14A20	Black	40G01/466579-001	Inspire	16% solution-dyed nylon	
5YT02	Embers	14A22	Raw Umber Dark	40G02/466579-002	Rhea	ZNC01/466564-001	Alcazar
5YT03	Parallel	14A26	Grey Blue Dark	40G03/466579-003	Noise	ZNC02/466564-002	Ironclad
5YT04	Octave	14A30	Sepia Dark	40G04/466579-004	Speedway	ZNC03/466564-003	Tune
5YT05	Musing	14A38	Emerald Dark	40G05/466579-005	Villanelle	ZNC04/466564-004	Bridegroom
5YT06	Summon	14A39	Yellow Dark	40G06/466579-006	Maestro	ZNC05/466564-005	Diode
5YT07	Dynamic	14A40	Orange	40G07/466579-007	Destiny	ZNC06/466564-006	Jest
5YT08	Signals	14A41	Sienna	40G08/466579-008	Possess	ZNC07/466564-007	Sanctuary
5YT09	Aspect	14A42	Olive Green Dark	40G09/466579-009	Waterside	ZNC08/466564-008	Aquarius
5YT10	Dedicate	14A43	Crimson	40G10/466579-010	Relax	ZNC09/466564-009	Houseboat
5YT11	Juniper	14A44	Crimson Dark Dark	40G11/466579-011	Delightful	ZNC10/466564-010	Olympian
5YT12	Cilantro	14A45	Violet Dark	40G12/466579-012	Parrotlet	ZNC11/466564-011	Tennis
5YT13	Hawthorn	14A46	Pink Dark Dark	40G13/466579-013	Verdurous	ZNC12/466564-012	Dressage
5YT14	Thread	14A47	Ultramarine Dark	40G14/466579-014	Bosky	ZNC13/466564-013	Zing
5YT15	Spalted	14A48	Cobalt Blue	40G15/466579-015	Acreage	ZNC14/466564-014	Bitterroot
5YT16	Warmer	14A49	Terra Cotta	40G16/466579-016	Allude	ZNC15/466564-015	Gemini
5YT17	Misted	14A50	Ochre Dark	40G17/466579-017	Tweed	ZNC16/466564-016	Posh
5YT18	Share			40G18/466579-018	Korma	ZNC17/466564-017	Sizzle
5YT19	Chord	Ingenu - Geiger Textile		40G19/466579-019	Fossilize	ZNC18/466564-018	Cheerful
5YT20	Heroic	Ancillary		40G20/466579-020	Cattail	ZNC19/466564-019	Watermelon
5YT21	Arpeggio	54" wide		40G21/466579-021	Shortcake	ZNC20/466564-020	Toucan
5YT22	Roots	28% wool		40G22/466579-022	Racecar	ZNC21/466564-021	Rosin
5YT23	Sumac	26% viscose		40G23/466579-023	Courtship	ZNC22/466564-022	Jousting
5YT24	Purl	25% acrylic		40G24/466579-024	Jam	ZNC23/466564-023	Jojoba
5YT25	Homeward	16% polyester		40G25/466579-025	Sparrow	ZNC24/466564-024	Dromedary
		5% cotton				ZNC25/466564-025	Toasty
		PFOA-Free stain resistant finish				ZNC26/466564-026	Casaba
Cozy						ZNC27/466564-027	Greenhouse
Ancillary/Seating						ZNC28/466564-028	Sibyl
54" wide						ZNC29/466564-029	Spearmint
100% wool						ZNC30/466564-030	Pothos
3CY01	Heathered Warm Grey	1GH01	Sand			ZNC31/466564-031	Calathea
3CY02	Heathered Rye Grass	1GH02	Fog			ZNC32/466564-032	Landscape
3CY03	Heathered Cool Grey	1GH03	Flannel			ZNC33/466564-033	Espalier
3CY05	Heathered Black	1GH04	Trench			ZNC34/466564-034	Gecko
3CY06	Heathered Persimmon	1GH05	Vermillion			ZNC35/466564-035	Meditation
3CY07	Heathered Loden	1GH06	Adriatic				
3CY09	Heathered Lagoon	1GH07	Umber				
3CY10	Heathered Twilight	1GH08	Charcoal				

Price category 5 continued on next page

- Maharam textiles are on assigned lead times **A**.
- Fabric numbers are listed as Herman Miller fabric number/Maharam fabric number.

Textile Colors

continued

Price Category 5

continued

Summit	
Ancillary/Seating	
54" wide	
100% silicone	
Polyester knit backing	
3SU02	Oyster
3SU03	Zinc
3SU04	Sparrow
3SU07	Black
3SU09	Beachglass
3SU10	Midnight

Vionette - Geiger Textile	
Ancillary	
55" wide	
100% polyester	
1GJ01	White Sand Mix
1GJ02	Desert Mix
1GJ03	Light Gray Mix
1GJ04	Pewter Mix
1GJ05	Cobalt Mix
1GJ06	Prussian Blue Mix
1GJ07	Chocolate Mix
1GJ08	Champagne
1GJ09	Morning Sky
1GJ10	Aquatic
1GJ11	Sapphire
1GJ12	Midnight Blue
1GJ13	Shadow
1GJ14	Java
1GJ15	Carbon
1GJ16	Black
1GJ17	Claret
1GJ18	Poppy

Price Category 6

Balance	
Seating	
For Embody® chairs	
100% polyester	
3512	Carbon
3513	Black

Outdoor Weave	
Ancillary	
For Eames® Aluminum Group	
Outdoor Chairs	
50% elastomeric	
50% polypropylene	
7203	Lead
7205	Graphite

Price Category 7

Customer's Own Leather	
See Order Information in	
Appendices. Assigned lead-time	
textile. A	

Bamboo	
Ancillary	
83% bamboo	
17% polyurethane	
1BB01	Ivory
1BB02	Russet
1BB03	Black

Beck – Maharam	
Ancillary/Seating	
55" wide	
78% wool	
22% nylon	
ZB301/466571-001	Overshadow
ZB302/466571-002	Molecule
ZB303/466571-003	Zeitgeist
ZB304/466571-004	Blacksmith
ZB305/466571-005	Cornerstone
ZB306/466571-006	Chainmail
ZB307/466571-007	Buckram
ZB308/466571-008	Callisto
ZB309/466571-009	Interlude
ZB310/466571-010	Letterpress
ZB311/466571-011	Memoir
ZB312/466571-012	Litmus
ZB313/466571-013	Stoic
ZB314/466571-014	Inkpad
ZB315/466571-015	Praxis
ZB316/466571-016	Astute
ZB317/466571-017	Percolate
ZB318/466571-018	Halocline
ZB319/466571-019	Semblance
ZB320/466571-020	Loch
ZB321/466571-021	Lido
ZB322/466571-022	Underwater
ZB323/466571-023	Tetrapod
ZB324/466571-024	Nymph
ZB325/466571-025	Appalachian

Beck continued	
ZB326/466571-026	Menthol
ZB327/466571-027	Woodruff
ZB328/466571-028	Malachite
ZB329/466571-029	Botanist
ZB330/466571-030	Woodlet
ZB331/466571-031	Katydid
ZB332/466571-032	Exuberant
ZB333/466571-033	Retrospect
ZB334/466571-034	Lambic
ZB335/466571-035	Argil
ZB336/466571-036	Brushstroke
ZB337/466571-037	Candescent
ZB338/466571-038	Reedbuck
ZB339/466571-039	Clayware
ZB340/466571-040	Curio
ZB341/466571-041	Whimsy
ZB342/466571-042	Effervescent
ZB343/466571-043	Lingonberry
ZB344/466571-044	Resplendent
ZB345/466571-045	Hollyhock
ZB346/466571-046	Filigree
ZB347/466571-047	Plutonic
ZB348/466571-048	Foundry
ZB349/466571-049	Patisserie
ZB390	Gold 007/032/033 *
ZB391	Russet 036/040/039 *
ZB392	Indigo 008/013/014 *
ZB393	Forest 006/031/028 *

* Colors available only on Girard Color Wheel Ottoman.

Price category 7 continued on next page

- Maharam textiles are on assigned lead times [A](#).
- Fabric numbers are listed as Herman Miller fabric number/Maharam fabric number.

Textile Colors

continued

Price Category 7

continued

Appendix: Textile Colors

Bellano - Geiger Textile	
Ancillary	
55" wide	
75% wool	
10% linen	
8% nylon	
7% alpaca	
1AX01	Pearl
1AX02	Fog
1AX03	Fawn
1AX04	Pumice
1AX05	Pewter
1AX06	Atlantic
1AX07	Black Green
1AX08	Adriatic
1AX09	Coffee
1AX10	Charcoal
1AX11	Umber
1AX12	Magenta
1AX13	Bittersweet
1AX14	Sunflower

Capri - Geiger Textile	
Ancillary	
55" wide	
36% cotton	
32% acrylic	
24% rayon	
8% polyester	
PFOA-Free stain resistant finish	
Acrylic backing	
17201	Snow
17202	Stone
17203	Trench
17204	Graphite
17205	Anthracite
17206	Light Silver
17207	Russet
17208	Chestnut Brown
17209	Sand
17210	Sterling
17211	Cobalt
17212	Ink

Mantle - Maharam	
Ancillary/Seating	
59% recycled polyester	
37% polyester	
4% spandex	
8PV01	Pavement
8PV02	Future
8PV03	Piper
8PV04	Manifesto
8PV05	Mapo
8PV06	Redwood
8PV07	Rocky
8PV08	Impala
8PV09	Warbler
8PV10	Guild
8PV11	Kinetic
8PV12	Behold
8PV13	Orb
8PV14	Sport
8PV15	Utopia
8PV16	True
8PV17	Galore
8PV18	Parsley
8PV19	Dare
8PV20	Branzino
8PV21	Network
8PV22	Standard
8PV23	Salamander
8PV24	Oscillate

Milaner - Geiger Textile	
Ancillary	
55" wide	
56% wool, 10% acrylic	
10% alpaca, 10% cotton	
8% nylon, 6% rayon	
17101	Linen
17102	Flax
17103	Bark
17104	Deep Navy
17105	Charcoal
17106	Medium Grey
17107	Ash
17108	Crimson

Panno di Dolce - Geiger Textile	
Ancillary	
55" wide	
65% wool	
20% nylon	
15% alpaca	
1AV01	Fog
1AV02	Dune
1AV03	Trench
1AV04	Flannel
1AV05	Charcoal
1AV06	Umber
1AV07	Deep Navy
1AV08	Graphite
1AV09	Orange
1AV10	Pink
1AV11	Deep Red
1AV12	Bright Green
1AV13	Cerulean Blue
1AV14	Deep Cerulean Blue

Pristina - Geiger Textile	
Ancillary	
55" wide	
37% wool	
25% viscose	
17% acrylic	
15% cotton	
6% polyester	
PFOA-Free stain resistant	
1JC01	Dove
1JC02	Goldstone
1JC03	Daybreak
1JC04	Pumice
1JC05	Cappuccino
1JC06	Gunmetal
1JC07	Caspian
1JC08	Café Noir

Resca - Geiger Textile	
Ancillary	
56" wide	
75% wool	
10% linen	
8% nylon	
7% alpaca	
1AW01	Fog
1AW02	Dune
1AW03	Trench
1AW04	Flannel
1AW05	Umber
1AW06	Bordeaux

Rowan - Maharam	
Ancillary/Seating	
77% wool	
12% nylon	
6% acrylic	
5% linen	
5K301	Kingdom
5K302	Northern
5K303	Rabbit
5K304	Elephant
5K305	Furrow
5K306	Heirloom
5K307	Appear
5K308	Repose
5K309	Blackcurrant
5K310	Courage
5K311	Bordeaux
5K312	Cherish
5K313	Brickfield
5K314	Hibiscus
5K315	Carnelian
5K316	Cinnabar
5K317	Toasted
5K318	Revea
5K319	Cortado
5K320	Medallion
5K321	Polenta

Price category 7 continued on next page

- Maharam textiles are on assigned lead times [A](#).
- Fabric numbers are listed as Herman Miller fabric number/Maharam fabric number.

Textile Colors

continued

Price Category 7

continued

Rowan continued	
5K322	Prized
5K323	Travertine
5K324	Companion
5K325	Library
5K326	Fable
5K327	Pixie
5K328	Arboretum
5K329	Ease
5K330	Sapling
5K331	Cottonwood
5K332	Scout
5K333	Valleyside
5K334	Ornament
5K335	Zucchini
5K336	Ethereal
5K337	Springtide
5K338	Traverse
5K339	Untold
5K340	Flowing
5K341	Laguna
5K342	Cerulean
5K343	Soundscape
5K344	Message
5K345	Freefall
5K346	Musical
5K347	Puzzle
5K348	Operatic
5K349	Daydream
5K350	Shale
5K351	Forward
5K352	Anthracite

Vesture - Geiger Textile	
Ancillary	
55" wide	
40% wool, 25% polyester	
20% silk, 15% nylon	
PFOA-Free stain resistant finish	
21701	Ashen
21702	Dark Blush
21703	Dusk
21704	Medium Gray
21705	Twilight

Wool Epinglé - Geiger Textile	
Ancillary	
54" wide	
100% wool	
16201	Swiss Red
16202	Orange
16203	Light Chestnut Brown
16204	Light Burnt Umber
16205	Pale Native Umber
16207	Grey
16208	Natier Blue
16209	Deep Cerulean Blue
16210	Anthracite
16211	Natural Native Umber
16212	Chestnut Brown

Wool Tweed - Geiger Textile	
Ancillary	
54" wide	
80% wool, 20% nylon	
16601	Trench
16602	Pewter
16603	Ruby
16604	Blue Gray
16605	Navy
16606	Umber
16607	Charcoal

Price Category 8

Breeze - Maharam	
Workspaces	
120" wide	
65% FR polyester	
35% post-consumer recycled	
FR polyester	
1QG06/283817-006	Meteorite
1QG09/283817-009	Serum

Luce - Maharam	
Ancillary/Seating	
59" wide	
75% post-consumer recycled wool	
20% polyester	
5% nylon	
ZLU01/466566-001	Brioche
ZLU02/466566-002	Blanched
ZLU03/466566-003	Relic
ZLU04/466566-004	Sinter
ZLU05/466566-005	Scoria
ZLU06/466566-006	Austere
ZLU07/466566-007	Pigment
ZLU08/466566-008	Alkali
ZLU09/466566-009	Tidal
ZLU10/466566-010	Imbue
ZLU11/466566-011	Reservoir
ZLU12/466566-012	Brine
ZLU13/466566-013	Undertone
ZLU14/466566-014	Prelude
ZLU15/466566-015	Submerge
ZLU16/466566-016	Cypress
ZLU17/466566-017	Awash
ZLU18/466566-018	Adriatic
ZLU19/466566-019	Province
ZLU20/466566-020	Virescent
ZLU21/466566-021	Nettle
ZLU22/466566-022	Agrarian
ZLU23/466566-023	Serpentine
ZLU24/466566-024	Laurel
ZLU25/466566-025	Clarion
ZLU26/466566-026	Gooseberry
ZLU27/466566-027	Swelter
ZLU28/466566-028	Etruscan
ZLU29/466566-029	Coulis
ZLU30/466566-030	Rubescant

Luce continued	
ZLU31/466566-031	Akoya
ZLU32/466566-032	Radiant
ZLU33/466566-033	Regent
ZLU34/466566-034	Spectral
ZLU35/466566-035	Thistle

Tempo - Maharam	
Ancillary	
55" wide	
100% polyester	
Polyester backing	
26S01/466589-001	Chert
26S02/466589-002	Grandstand
26S03/466589-003	Restful
26S04/466589-004	Battleship
26S05/466589-005	Lavender
26S06/466589-006	Dockside
26S07/466589-007	Swimming
26S08/466589-008	Ambience
26S09/466589-009	Adornment
26S10/466589-010	Remedy
26S11/466589-011	Fang
26S12/466589-012	Inshore
26S13/466589-013	Camouflage
26S14/466589-014	Mesclun
26S15/466589-015	Farmland
26S16/466589-016	Tadpole
26S17/466589-017	Purr
26S18/466589-018	Snowman
26S19/466589-019	Beehive
26S20/466589-020	Gazelle
26S21/466589-021	Shiitake
26S22/466589-022	Flaxseed
26S23/466589-023	Crawdad
26S24/466589-024	Flowery
26S25/466589-025	Burgundy
26S26/466589-026	Rangoli
26S27/466589-027	Petunia
26S28/466589-028	Campsite

Price category 8 continued on next page

- Maharam textiles are on assigned lead times ^A.
- Fabric numbers are listed as Herman Miller fabric number/Maharam fabric number.

Textile Colors

continued

Price Category 8

continued

Price Category 9

Appendix: Textile Colors

Whim	
Ancillary	
54" wide	
34% viscose	
33% acrylic	
17% wool	
8% polyester	
9DA01	Warm White
9DA02	Rye
9DA03	Mustard Seed
9DA04	Terra Cotta
9DA05	Fir
9DA06	Navy
9DA07	Pewter

Alpaca Mohair - Geiger Textile	
Ancillary	
54" wide	
63% alpaca	
21% cotton, 16% polyester	
18510	Dune
18511	Trench
18512	Vicuna
18570	Sepia
18571	Umber
18580	Fog
18581	Flannel
18582	Charcoal

Campana – Maharam	
Ancillary/Seating	
59" wide	
85% wool	
15% nylon	
ZC001/466571-001	Viverine
ZC002/466571-002	Lithograph
ZC003/466571-003	Moonscape
ZC004/466571-004	Brevity
ZC005/466571-005	Linear
ZC006/466571-006	Hinterland
ZC007/466571-007	Mural
ZC008/466571-008	Sloe
ZC009/466571-009	Interstellar
ZC010/466571-010	Mythology
ZC011/466571-011	Scintillate
ZC012/466571-012	Succession
ZC013/466571-013	Visceral
ZC014/466571-014	Hemisphere
ZC015/466571-015	Troposphere
ZC016/466571-016	Skye
ZC017/466571-017	Seaward
ZC018/466571-018	Nemorous
ZC019/466571-019	Allegory
ZC020/466571-020	Olivine
ZC021/466571-021	Reptilian
ZC022/466571-022	Basil
ZC023/466571-023	Fanleaf
ZC024/466571-024	Beachgrass
ZC025/466571-025	Hayfield

Campana continued	
ZC026/466571-026	Freesia
ZC027/466571-027	Rhodium
ZC028/466571-028	Undercoat
ZC029/466571-029	Airbrush
ZC030/466571-030	Shellfish
ZC031/466571-031	Mojave
ZC032/466571-032	Renaissance
ZC033/466571-033	Decoupage
ZC034/466571-034	Outback
ZC035/466571-035	Millipede

Gemma – Maharam	
Ancillary/Seating	
55" wide	
85% wool	
15% nylon	
ZGE01/466568-001	Crinoline
ZGE02/466568-002	Angelic
ZGE03/466568-003	Savory
ZGE04/466568-004	Honeycomb
ZGE05/466568-005	Gilded
ZGE06/466568-006	Paddleboat
ZGE07/466568-007	Stagecoach
ZGE08/466568-008	Waterbuck
ZGE09/466568-009	Earnest
ZGE10/466568-010	Auric
ZGE11/466568-011	Carmine
ZGE12/466568-012	Serape
ZGE13/466568-013	Ferric
ZGE14/466568-014	Canyon
ZGE15/466568-015	Alembic
ZGE16/466568-016	Patio
ZGE17/466568-017	Sorrel
ZGE18/466568-018	Root

Gemma continued	
ZGE19/466568-019	Mansion
ZGE20/466568-020	Buff
ZGE21/466568-021	Starch
ZGE22/466568-022	Dawn
ZGE23/466568-023	Countryside
ZGE24/466568-024	Dewy
ZGE25/466568-025	Reliquary
ZGE26/466568-026	Deluge
ZGE27/466568-027	Overlay
ZGE28/466568-028	Electron
ZGE29/466568-029	Sheath
ZGE30/466568-030	Quietude
ZGE31/466568-031	Jargon
ZGE32/466568-032	Powder
ZGE33/466568-033	Tide
ZGE34/466568-034	Outwash
ZGE35/466568-035	Enamored
ZGE36/466568-036	Smitten
ZGE37/466568-037	Revere
ZGE38/466568-038	Mangosteen
ZGE39/466568-039	Allium
ZGE40/466568-040	Immense
ZGE41/466568-041	Chamber
ZGE42/466568-042	Cosmos
ZGE43/466568-043	Inkling
ZGE44/466568-044	Rainwater
ZGE45/466568-045	Shade
ZGE46/466568-046	Pendant
ZGE47/466568-047	Axial
ZGE48/466568-048	Fervent
ZGE49/466568-049	Legacy
ZGE50/466568-050	Caliber
ZGE51/466568-051	Temple
ZGE52/466568-052	Evenfall

Price category 9 continued on next page

- Maharam textiles are on assigned lead times [A](#).
- Fabric numbers are listed as Herman Miller fabric number/Maharam fabric number.

Textile Colors

continued

Price Category 9

continued

Jasper - Maharam	
Ancillary/Seating	
53" wide	
55% wool	
27% solution-dyed nylon	
18% cotton	
ZJA01/466563-001 Thrill	
ZJA02/466563-002 Anise	
ZJA03/466563-003 Grapefruit	
ZJA04/466563-004 Lifeguard	
ZJA05/466563-005 Heartfelt	
ZJA06/466563-006 Corsage	
ZJA07/466563-007 Earthenware	
ZJA08/466563-008 Bear	
ZJA09/466563-009 Firelight	
ZJA10/466563-010 Dreamcatcher	
ZJA11/466563-011 Bobcat	
ZJA12/466563-012 Glacial	
ZJA13/466563-013 Vaporize	
ZJA14/466563-014 Trapdoor	
ZJA15/466563-015 Halcyon	
ZJA16/466563-016 Observatory	
ZJA17/466563-017 Steamboat	
ZJA18/466563-018 Aquathlon	
ZJA19/466563-019 Cloudless	
ZJA20/466563-020 Briny	
ZJA21/466563-021 Magical	
ZJA22/466563-022 Picnic	
ZJA23/466563-023 Herbage	
ZJA24/466563-024 Pasture	
ZJA25/466563-025 Courtyard	
ZJA26/466563-026 Leapfrog	

Leather	
Ancillary/Seating	
approx. 50 sq. ft. per hide	
100% leather	
2101 Ivory	
2109 Black *	
2110 Smoke	
2111 Graphite	
2112 Khaki	
2113 Rattan	
2114 Truffle	
2115 Alpine	
2116 Haze	
2117 Sable Grey	
2118 Dark Mineral **	
2119 Dark Carbon ***	
2120 Cranberry	
2121 Deep Sea	

* Armpad color available on Aeron® Chair, Graphite.
 ** Armpad color available on Aeron Chair, Mineral.
 *** Armpad color available on Aeron Chair, Carbon.

Price Category 10

Bristol Leather - Geiger Textile	
Ancillary	
approx. 55 sq. ft. per hide	
100% leather	
5-507 Black	
5-511 Putty	
5-519 Hunter	
5-520 White	
5-521 Ivory	
5-522 Parchment	
5-537 Caribbean	
5-546 Pumice	
5-547 Smoke	
5-548 Charcoal	
5-549 Dark Shale	
5-556 Downtown Grey	
5-557 City Night	
5-559 Ash Grey	
5-563 Champagne	
5-564 Chestnut Brown	
5-565 Dark Sienna	
5-566 Earthen	
5-567 Desert	
5-568 British Green	
5-579 Paris Blue	
5-583 Atlantic	
5-592 Camel	
5-594 Taupe	
5-597 Pure *	
5-598 Cream	
5-600 Midnight Blue	
5-603 Sangria	
5-604 Swiss Red	
5-605 Nordic Yellow	
5-606 Sky Grey	
5-608 Natural	

* Color not available on Saiba Chair.

Firma – Maharam	
Ancillary/Seating	
55" wide	
78% wool	
22% nylon	
3KH01/466582-001 Wrath	
3KH02/466582-002 Pantomime	
3KH03/466582-003 Shaded	
3KH04/466582-004 Prologue	
3KH05/466582-005 Framework	
3KH06/466582-006 Railroad	
3KH07/466582-007 Grommet	
3KH08/466582-008 Lunisolar	
3KH09/466582-009 Snowpack	
3KH10/466582-010 Coldsnap	
3KH11/466582-011 Sealift	
3KH12/466582-012 Brood	
3KH13/466582-013 Intertidal	
3KH14/466582-014 Confide	
3KH15/466582-015 Secluded	
3KH16/466582-016 Leisure	
3KH17/466582-017 Portfolio	
3KH18/466582-018 Strato	
3KH19/466582-019 Fogbow	
3KH20/466582-020 Snowcone	
3KH21/466582-021 Kazoo	
3KH22/466582-022 Esteem	
3KH23/466582-023 Mackerel	
3KH24/466582-024 Brooch	
3KH25/466582-025 Caesious	
3KH26/466582-026 Islet	
3KH27/466582-027 Biosphere	
3KH28/466582-028 Hilltop	
3KH29/466582-029 Arboreal	
3KH30/466582-030 Lineage	
3KH31/466582-031 Comfrey	
3KH32/466582-032 Circe	
3KH33/466582-033 Ecosystem	
3KH34/466582-034 Knack	
3KH35/466582-035 Watt	
3KH36/466582-036 Epiphany	
3KH37/466582-037 Gamma	
3KH38/466582-038 Taxicab	
3KH39/466582-039 Varietal	
3KH40/466582-040 Tale	

Price category 10 continued on next page

- Maharam textiles are on assigned lead times A.
- Fabric numbers are listed as Herman Miller fabric number/Maharam fabric number.

Textile Colors

continued

Price Category 10

continued

Firma continued	
3KH41/466582-041	Elemental
3KH42/466582-042	Cuff
3KH43/466582-043	Emu
3KH44/466582-044	Tempeh
3KH45/466582-045	Tephra
3KH46/466582-046	Shellac
3KH47/466582-047	Emporium
3KH48/466582-048	Keratin
3KH49/466582-049	Camwood
3KH50/466582-050	Gloam
3KH51/466582-051	Novela
3KH52/466582-052	Fruitpunch
3KH53/466582-053	Decant
3KH54/466582-054	Milkshake
3KH55/466582-055	Metaphysic
3KH56/466582-056	Carafe
3KH57/466582-057	Voyager
3KH58/466582-058	Tenebrous
3KH59/466582-059	Subtext
3KH60/466582-060	Silent

Gemma Multi – Maharam	
Ancillary/Seating	
55" wide	
85% wool	
15% nylon	
ZGF01/466569-001	Andromeda
ZGF02/466569-002	Dappled
ZGF03/466569-003	Lyra
ZGF04/466569-004	Flaunt
ZGF05/466569-005	Celluloid
ZGF06/466569-006	Hydrozoa
ZGF07/466569-007	Firefly
ZGF08/466569-008	Pisces
ZGF09/466569-009	Strath
ZGF10/466569-010	Erosion
ZGF11/466569-011	Cabaret
ZGF12/466569-012	Candytuft
ZGF13/466569-013	Juice
ZGF14/466569-014	Fairground
ZGF15/466569-015	Copperplate
ZGF16/466569-016	Sunbird
ZGF17/466569-017	Cinematic
ZGF18/466569-018	Clairvoyant

Gemma Multi continued	
ZGF19/466569-019	Crocus
ZGF20/466569-020	Memoir
ZGF21/466569-021	Roulette
ZGF22/466569-022	Voltaic
ZGF23/466569-023	Compote
ZGF24/466569-024	Lambent
ZGF25/466569-025	Twister
ZGF26/466569-026	Chronicle
ZGF27/466569-027	Sidereal
ZGF28/466569-028	Tanzanite
ZGF29/466569-029	Crystalize
ZGF30/466569-030	Chromium
ZGF31/466569-031	Pallium
ZGF32/466569-032	Spectre
ZGF33/466569-033	Courgette
ZGF34/466569-034	Viper
ZGF35/466569-035	Sunlit
ZGF36/466569-036	Heavenly
ZGF37/466569-037	Vernal
ZGF38/466569-038	Cress
ZGF39/466569-039	Limn
ZGF40/466569-040	Horseradish
ZGF41/466569-041	Shandy
ZGF42/466569-042	Granary
ZGF43/466569-043	Percolate
ZGF44/466569-044	Motor
ZGF45/466569-045	Unicorn
ZGF46/466569-046	Lobster
ZGF47/466569-047	Rhododendron
ZGF48/466569-048	Taffy
ZGF49/466569-049	Rishi
ZGF50/466569-050	Backcountry
ZGF51/466569-051	Buckthorn
ZGF52/466569-052	Coniferous
ZGF53/466569-053	Delphic
ZGF54/466569-054	Hieroglyph
ZGF55/466569-055	Eiderdown
ZGF56/466569-056	Sandbar
ZGF57/466569-057	Tanager

Gemma Multi Reverse – Maharam	
Ancillary/Seating	
55" wide	
85% wool	
15% nylon	
ZGF58/466569-101	Andromeda
	Reverse
ZGF59/466569-102	Dappled
	Reverse
ZGF60/466569-103	Lyra
	Reverse
ZGF61/466569-104	Flaunt
	Reverse
ZGF62/466569-105	Celluloid
	Reverse
ZGF63/466569-106	Hydrozoa
	Reverse
ZGF64/466569-107	Firefly
	Reverse
ZGF65/466569-108	Pisces
	Reverse
ZGF66/466569-109	Strath
	Reverse
ZGF67/466569-110	Erosion
	Reverse
ZGF68/466569-111	Cabaret
	Reverse
ZGF69/466569-112	Candytuft
	Reverse
ZGF70/466569-113	Juice
	Reverse
ZGF71/466569-114	Fairground
	Reverse
ZGF72/466569-115	Copperplate
	Reverse
ZGF73/466569-116	Sunbird
	Reverse
ZGF74/466569-117	Cinematic
	Reverse
ZGF75/466569-118	Clairvoyant
	Reverse
ZGF76/466569-119	Crocus
	Reverse
ZGF77/466569-120	Memoir
	Reverse

Gemma Multi Reverse continued	
ZGF78/466569-121	Roulette
	Reverse
ZGF79/466569-122	Voltaic
	Reverse
ZGF80/466569-123	Compote
	Reverse
ZGF81/466569-124	Lambent
	Reverse
ZGF82/466569-125	Twister
	Reverse
ZGF83/466569-126	Chronicle
	Reverse
ZGF84/466569-127	Sidereal
	Reverse
ZGF85/466569-128	Tanzanite
	Reverse
ZGF86/466569-129	Crystalize
	Reverse
ZGF87/466569-130	Chromium
	Reverse
ZGF88/466569-131	Pallium
	Reverse
ZGF89/466569-132	Spectre
	Reverse
ZGF90/466569-133	Courgette
	Reverse
ZGF91/466569-134	Viper
	Reverse
ZGF92/466569-135	Sunlit
	Reverse
ZGF93/466569-136	Heavenly
	Reverse
ZGF94/466569-137	Vernal
	Reverse
ZGF95/466569-138	Cress
	Reverse
ZGF96/466569-139	Limn
	Reverse
ZGF97/466569-140	Horseradish
	Reverse
ZGF98/466569-141	Shandy
	Reverse
ZGF99/466569-142	Granary
	Reverse

- Maharam textiles are on assigned lead times [A](#).
- Fabric numbers are listed as Herman Miller fabric number/Maharam fabric number.

Price category 10 continued on next page

Textile Colors

continued

Price Category 10

continued

Gemma Multi Reverse <i>continued</i>	
ZGFA0/466569-143	Percolate
	Reverse
ZGFA1/466569-144	Motor
	Reverse
ZGFA2/466569-145	Unicorn
	Reverse
ZGFA3/466569-146	Lobster
	Reverse
ZGFA4/466569-147	Rhododendron
	Reverse
ZGFA5/466569-148	Taffy
	Reverse
ZGFA6/466569-149	Rishi
	Reverse
ZGFA7/466569-150	Backcountry
	Reverse
ZGFA8/466569-151	Buckthorn
	Reverse
ZGFA9/466569-152	Coniferous
	Reverse
ZGFB0/466569-153	Delphic
	Reverse
ZGFB1/466569-154	Hieroglyph
	Reverse
ZGFB2/466569-155	Eiderdown
	Reverse
ZGFB3/466569-157	Tanager
	Reverse
Petra - Maharam	
Ancillary/Seating	
55" wide	
70% wool	
19% linen	
11% nylon	
ZP401/466580-001	Hieroglyph
ZP402/466580-002	Interior
ZP403/466580-003	Samovar
ZP404/466580-004	Calcite
ZP405/466580-005	Silversmith
ZP406/466580-006	Rivet
ZP407/466580-007	Carpolite
ZP408/466580-008	Bonbon

Petra <i>continued</i>	
ZP409/466580-009	Dreamy
ZP410/466580-010	Bejewel
ZP411/466580-011	Sashimi
ZP412/466580-012	Spirula
ZP413/466580-013	Chalet
ZP414/466580-014	Reindeer
ZP415/466580-015	Nostalgia
ZP416/466580-016	Trove
ZP417/466580-017	Narcissus
ZP418/466580-018	Yurt
ZP419/466580-019	Congee
ZP420/466580-020	Genepy
ZP421/466580-021	Herbaceous
ZP422/466580-022	Paddock
ZP423/466580-023	Precious
ZP424/466580-024	Biome
ZP425/466580-025	Tinted
ZP426/466580-026	Pelagic
ZP427/466580-027	Bluebill
ZP428/466580-028	Chicory
ZP429/466580-029	Eaglet
ZP430/466580-030	Permafrost
ZP431/466580-031	Atlantic
ZP432/466580-032	Airstream
ZP433/466580-033	Debonair
Superweave - Maharam	
Ancillary	
54" wide	
75% polyester	
25% cotton	
Z2203/466241-005	Sienna
Z2204/466241-002	Ochre
Z2207/466241-004	Marine
Z2208/466241-003	Olive
Z2220/466241-001	Orange and Pink

Price Category 11

Felix - Maharam	
Ancillary/Seating	
85% wool	
15% nylon	
3BS01	Angular
3BS02	Shark
3BS03	Easy
3BS04	Cue
3BS05	Rye
3BS06	Champion
3BS07	Between
3BS08	Propose
3BS09	Rising
3BS10	Tile
3BS11	Place
3BS12	Kernel
3BS13	Pinnacle
3BS14	Darling
3BS15	Seasonal
3BS16	Shipmate
3BS17	Jump
3BS18	Geyser
3BS19	Team

Prone Leather - Maharam	
Ancillary	
approx. 50 sq. ft. per hide	
100% leather	
protective top coat	
1NX01/700020-001	Lotus
1NX02/700020-002	Timbre
1NX03/700020-003	Essence
1NX04/700020-004	Script
1NX05/700020-005	Gambit
1NX06/700020-006	Obsidian
1NX07/700020-007	Sail
1NX09/700020-009	Vine
1NX10/700020-010	Yarrow
1NX13/700020-013	Balsa
1NX14/700020-014	Shore
1NX15/700020-015	Bricolage
1NX17/700020-017	Ledge
1NX19/700020-019	Mantra
1NX20/700020-020	Java
1NX21/700020-021	Lute
1NX22/700020-022	Glow
1NX23/700020-023	Hickory
Tenera Leather - Geiger Textile	
Ancillary	
approx. 55 sq. ft. per hide	
100% leather	
17501	Cement
17502	Marzipan
17504	Raw Sienna
17505	Maple
17508	Cranberry
17510	Dark Chocolate
17511	Black
17512	Carbon
17513	Sapphire

Appendix: Textile Colors

- Maharam textiles are on assigned lead times [A](#).
- Fabric numbers are listed as Herman Miller fabric number/Maharam fabric number.

Textile Colors

continued

Price Category 12-13

No fabrics available at this time.

Price Category 14

Lanalux - Maharam

Ancillary
 54" wide
 100% wool
 Z1375/466240-005 Black/White
 Z1378/466240-006 Olive/Black
 Z1380/466240-001 Natural
 Z1383/466240-002 Umber
 Z1384/466240-007 Natural/Black
 Z1386/466240-003 Orange
 Z1387/466240-004 Crimson

Price Category A

No fabrics available at this time.

Price Category B

Medium – Maharam

Ancillary/Seating/Workspaces
 54" wide
 100% polyester
 VM01/463490-001 Raven
 VM02/463490-002 Smoke
 VM03/463490-003 Alloy
 VM04/463490-004 Flax
 VM07/463490-007 Espresso
 VM14/463490-014 Laser
 VM16/463490-016 Port
 VM22/463490-022 Marina
 VM29/463490-029 Pistachio
 VM32/463490-032 Prospect
 VM36/463490-036 Delight
 VM39/463490-039 Nautical
 VM40/463490-040 Pool
 VM44/463490-044 Washed
 VM45/463490-045 Sculpture
 VM46/463490-046 Thatched
 VM47/463490-047 Hike
 VM48/463490-048 Tangle
 VM49/463490-049 Pacific
 VM50/463490-050 Cosmic
 VM51/463490-051 Cascade
 VM52/463490-052 Blackberry
 VM53/463490-053 Nasturtium

Messenger – Maharam

Ancillary/Seating/Workspaces
 54" wide
 78% post-industrial recycled polyester
 15% polyester, 7% nylon
 TI07/458640-007 Shadow
 TI08/458640-008 Bayou *
 TI24/458640-024 Poppy
 TI25/458640-025 Mao
 TI29/458640-029 Onyx *
 TI31/458640-031 Cloud *
 TI38/458640-038 Depth *
 TI40/458640-040 Nile *
 TI41/458640-041 Azure *

Price category B continued on next page

- Maharam textiles are on assigned lead times [A](#).
- Fabric numbers are listed as Herman Miller fabric number/Maharam fabric number.

Textile Colors

continued

Price Category B

continued

Messenger continued	
TI45/458640-045	Cactus *
TI46/458640-046	Ice * **
TI48/458640-048	Neon
TI50/458640-050	Hydrangea
TI53/458640-053	Tangelo
TI54/458640-054	Lumine *
TI58/458640-058	Snow ** ***
TI60/458640-060	Peridot
TI61/458640-061	Capri *
TI62/458640-062	Ultramarine
TI63/458640-063	Squall
TI66/458640-066	Cassis
TI67/458640-067	Aster
TI69/458640-069	Cherry
TI70/458640-070	Vibrant
TI71/458640-071	Satsuma *
TI72/458640-072	Maize
TI76/458640-076	Fossil
TI77/458640-077	Ash
TI78/458640-078	Tusk
TI79/458640-079	Oyster **
TI81/458640-081	Husk
TI84/458640-084	Robust
TI85/458640-085	Beyond
TI86/458640-086	Voyage *
TI87/458640-087	Everglade
TI89/458640-089	Blanch ***
TI90/458640-090	Longspur
TI91/458640-091	Vireo
TI92/458640-092	Dipper
TI93/458640-093	Gale
TI94/458640-094	Hunter
TI95/458640-095	Lime
TI96/458640-096	Apple
TI97/458640-097	Krill
TI98/458640-098	Catalyst

* Colors available on 20-day lead time.

** Colors not available on Eames Molded Fiberglass and Molded Plastic Side Chairs.

*** Colors not available on Valor Seating.

- Maharam textiles are on assigned lead times [A](#).
- Fabric numbers are listed as Herman Miller fabric number/Maharam fabric number.

Price Category C

Manner - Maharam	
Ancillary/Seating/Workspaces	
54" wide	
65% post-industrial recycled polyester	
35% post-consumer recycled polyester	
Z2701/466177-001	Magic
Z2702/466177-002	Carob
Z2703/466177-003	Porpoise
Z2704/466177-004	Flint
Z2705/466177-005	Hush *
Z2706/466177-006	Nuance
Z2711/466177-011	Ember
Z2712/466177-012	Wagon
Z2713/466177-013	Ablaze
Z2714/466177-014	Peel
Z2716/466177-016	Butterscotch
Z2717/466177-017	Harvest
Z2720/466177-020	Parakeet
Z2722/466177-022	Aquatic
Z2723/466177-023	Cottage
Z2724/466177-024	Dahlia
Z2725/466177-025	Vivid
Z2726/466177-026	Basin
Z2727/466177-027	Schooner
Z2728/466177-028	Slope
Z2729/466177-029	Silverpoint
Z2730/466177-030	Lattice
Z2731/466177-031	Smoky
Z2732/466177-032	Magnetic
Z2733/466177-033	Woad
Z2734/466177-034	Resolute
Z2735/466177-035	Cruise
Z2736/466177-036	Atmospheric
Z2737/466177-037	Cloudburst
Z2738/466177-038	Tidewater
Z2739/466177-039	Firth
Z2740/466177-040	Oceanside
Z2741/466177-041	Grandeur
Z2742/466177-042	Comfort
Z2743/466177-043	Dill
Z2744/466177-044	Poplar
Z2745/466177-045	Citronella
Z2746/466177-046	Passerine

Manner continued	
Z2747/466177-047	Southwest
Z2748/466177-048	Roseate
Z2749/466177-049	Charisma
Z2750/466177-050	Siltstone
Z2751/466177-051	Kimono
Z2752/466177-052	Valiant
Z2753/466177-053	Baroness

* Color not available on Eames Aluminum Group, Executive Chairs, Upholstered Molded Plywood Chairs, and Sofa Compact.

Merit - Maharam	
Ancillary/Seating	
54" wide	
76% post-industrial recycled polyester	
24% polyester	
PFOA-Free stain resistant	
88Z01/466444-001	Trickle
88Z02/466444-002	Beluga
88Z03/466444-003	Gunmetal
88Z04/466444-004	Blackout
88Z05/466444-005	Superior
88Z06/466444-006	Ocean
88Z07/466444-007	Highborn
88Z08/466444-008	Immersed
88Z09/466444-009	Rainfall
88Z10/466444-010	Blizzard
88Z11/466444-011	Poolside
88Z12/466444-012	Steel
88Z13/466444-013	Zircon
88Z14/466444-014	Ripple
88Z15/466444-015	Aegean
88Z16/466444-016	Armada
88Z17/466444-017	Hedera
88Z18/466444-018	Rainforest
88Z19/466444-019	Gator
88Z20/466444-020	Vineyard
88Z21/466444-021	Pine
88Z22/466444-022	Kiwi
88Z23/466444-023	Kookaburra

Merit continued	
88Z24/466444-024	Bellini
88Z25/466444-025	Sunflower
88Z26/466444-026	Sandstorm
88Z27/466444-027	Mudder
88Z28/466444-028	Lynx
88Z29/466444-029	Farro
88Z30/466444-030	Manila
88Z31/466444-031	Starfish
88Z32/466444-032	Brass
88Z33/466444-033	Arrow
88Z34/466444-034	Gelato
88Z35/466444-035	Nectarine
88Z36/466444-036	Macaron
88Z37/466444-037	Alert
88Z38/466444-038	Goji
88Z39/466444-039	Cabernet
88Z40/466444-040	Eggplant
88Z41/466444-041	Hawk
88Z42/466444-042	Stag
88Z43/466444-043	Overcast

Metric - Maharam	
Ancillary/Seating/Workspaces	
54" wide	
51% post-industrial recycled polyester	
49% polyester	
Z302/466014-002	Fog
Z303/466014-003	Fleece
Z312/466014-012	Cardinal
Z313/466014-013	Lava
Z318/466014-018	Pollen
Z320/466014-020	Alligator
Z323/466014-023	Tar
Z324/466014-024	Anchor
Z326/466014-026	Admiral
Z327/466014-027	Seaport
Z328/466014-028	Scuba
Z329/466014-029	Skate
Z330/466014-030	Hopscotch
Z331/466014-031	Film
Z332/466014-032	Whale
Z333/466014-033	Downpour
Z334/466014-034	Midday

Price category C continued on next page

Textile Colors

continued

Price Category C

continued

Metric continued	
Z335/466014-035	Talisman
Z336/466014-036	Hedgerow
Z337/466014-037	Snorkel
Z338/466014-038	Highway
Z339/466014-039	Canary
Z340/466014-040	Sunny
Z341/466014-041	Aztec
Z342/466014-042	Fruit
Z343/466014-043	Galah
Z344/466014-044	Kiln
Z345/466014-045	Moth

Murmur - Maharam	
Ancillary/Seating	
55" wide	
100% polyester	
PFOA-Free stain resistant	
8EY01/466446-001	Gust
8EY02/466446-002	Harmonica
8EY03/466446-003	Canopy
8EY04/466446-004	Dim
8EY05/466446-005	Peppercorn
8EY06/466446-006	Cauldron
8EY07/466446-007	Conquer
8EY08/466446-008	Rapids
8EY09/466446-009	Seawater
8EY10/466446-010	Baby
8EY11/466446-011	Elderberry
8EY12/466446-012	Iceberg
8EY13/466446-013	Tallgrass
8EY14/466446-014	Underground
8EY15/466446-015	Biome
8EY16/466446-016	Cask
8EY17/466446-017	Argan
8EY18/466446-018	Sundown
8EY19/466446-019	Ignite
8EY20/466446-020	Sultry
8EY21/466446-021	Sangria

Price Category D

Bluff - Maharam	
Ancillary/Seating	
54" wide	
100% polyurethane	
Ink-resistant protective top coat	
Polyester backing	
8I801/466489-001	Loom
8I802/466489-002	Helm
8I803/466489-003	Cruller
8I804/466489-004	Folklore
8I805/466489-005	Beguile
8I806/466489-006	Sherpa
8I807/466489-007	Teleport
8I808/466489-008	Annex
8I809/466489-009	Lorimer
8I810/466489-010	Cinema
8I811/466489-011	Zip
8I812/466489-012	Coach
8I813/466489-013	Supernova
8I814/466489-014	Pirate
8I815/466489-015	Academy
8I816/466489-016	Disco
8I817/466489-017	Equator
8I818/466489-018	Brink
8I819/466489-019	Scene
8I820/466489-020	Petrichor
8I821/466489-021	Exotic
8I822/466489-022	Fauna
8I823/466489-023	Calabash
8I824/466489-024	Fuscous
8I825/466489-025	Wildling
8I826/466489-026	Blitz
8I827/466489-027	Allspice
8I828/466489-028	Lumos
8I829/466489-029	Pilot
8I830/466489-030	Jukebox
8I831/466489-031	Dugout
8I832/466489-032	Claret
8I833/466489-033	Flamenco

Mode - Maharam	
Ancillary/Seating/Workspaces	
54" wide	
80% post-consumer recycled polyester	
20% polyester	
PFOA-Free stain resistant finish	
ZMD01/466337-001	Stroll
ZMD02/466337-002	Intaglio
ZMD03/466337-003	Ominous
ZMD04/466337-004	Machine
ZMD05/466337-005	Talus
ZMD06/466337-006	Marsh
ZMD07/466337-007	Hollow
ZMD08/466337-008	Sycamore
ZMD09/466337-009	Clavicle
ZMD10/466337-010	Billygoat
ZMD11/466337-011	Spindle
ZMD12/466337-012	Lemon
ZMD13/466337-013	Oxeye
ZMD14/466337-014	Henge
ZMD15/466337-015	Goldenrod
ZMD16/466337-016	Cottontail
ZMD17/466337-017	Lioness
ZMD18/466337-018	Oriole
ZMD19/466337-019	Rust
ZMD20/466337-020	Carotene
ZMD21/466337-021	Blush
ZMD22/466337-022	Vermilion
ZMD23/466337-023	Alder
ZMD24/466337-024	Kermes
ZMD25/466337-025	Barberry
ZMD26/466337-026	Petal
ZMD27/466337-027	Valley
ZMD28/466337-028	Odyssey
ZMD29/466337-029	Ballpoint
ZMD30/466337-030	Toile
ZMD31/466337-031	Paradise

Mode continued	
ZMD32/466337-032	Angelfish
ZMD33/466337-033	Denim
ZMD34/466337-034	Crush
ZMD35/466337-035	Jetty
ZMD36/466337-036	Saltwater
ZMD37/466337-037	Mallard
ZMD38/466337-038	Celtic
ZMD39/466337-039	Eucalyptus
ZMD40/466337-040	Bonsai
ZMD41/466337-041	Sassafras
ZMD42/466337-042	Yucca
ZMD43/466337-043	Lichen

Spiral - Maharam	
Workspaces	
66" wide	
100% polyester	
ZS301/901882-001	Chalk
ZS303/901882-003	Wheat
ZS304/901882-004	Mica
ZS305/901882-005	Pavement
ZS306/901882-006	Graphite

- Maharam textiles are on assigned lead times [A](#).
- Fabric numbers are listed as Herman Miller fabric number/Maharam fabric number.

Textile Colors

continued

Price Category E

Article – Maharam	
Ancillary/Seating	
54" wide	
100% vinyl	
ZAT08/458600-008	Marina
ZAT13/458600-013	Flume
ZAT14/458600-014	Storm
ZAT15/458600-015	Toast
ZAT19/458600-019	Fleece
ZAT22/458600-022	Stone
ZAT26/458600-026	Mercury
ZAT29/458600-029	Bluegrass
ZAT31/458600-031	Truffle
ZAT32/458600-032	Gravel
ZAT33/458600-033	Value
ZAT34/458600-034	Tint
ZAT35/458600-035	Snowflake
ZAT36/458600-036	Chalice
ZAT37/458600-037	Trail
ZAT38/458600-038	Pyramid
ZAT39/458600-039	Desert
ZAT40/458600-040	Lei
ZAT41/458600-041	Rouge
ZAT42/458600-042	Karma
ZAT43/458600-043	Opal
ZAT44/458600-044	Periwinkle
ZAT45/458600-045	Vampire
ZAT46/458600-046	Surf
ZAT47/458600-047	Plumage

Flock - Maharam	
Workspaces	
63" wide	
100% polyester	
ZF301/901892-001	Calm
ZF302/901892-002	Course
ZF303/901892-003	Highlight
ZF305/901892-005	Poppy
ZF306/901892-006	Briefcase
ZF307/901892-007	Monkstrap
ZF308/901892-008	Quag
ZF309/901892-009	Pistachio
ZF310/901892-010	Froth
ZF311/901892-011	Celadon
ZF312/901892-012	Highsea
ZF313/901892-013	China
ZF314/901892-014	Victorian
ZF315/901892-015	Commander
ZF316/901892-016	Raven
ZF317/901892-017	Aluminum

Micro – Maharam	
Ancillary	
54" wide	
100% vinyl	
ZMB01/466099-001	Muslin
ZMB04/466099-004	Basalt
ZMB06/466099-006	Phantom
ZMB07/466099-007	Depth
ZMB08/466099-008	Cottage
ZMB09/466099-009	Hunter
ZMB11/466099-011	Tomatillo
ZMB12/466099-012	Brew
ZMB14/466099-014	Tang
ZMB15/466099-015	Risk

Parallel – Maharam	
Workspaces	
66" wide	
100% recycled polyester	
TT03/901180-003	Fog
TT22/901180-022	Sterling
TT23/901180-023	Linen
TT24/901180-024	Pea
TT27/901180-027	Boulder
TT28/901180-028	Stream
TT29/901180-029	Shiitake
TT32/901180-032	Brandy
TT33/901180-033	Crater
TT36/901180-036	Quail

Price Category F

Apt – Maharam	
Ancillary/Seating	
54" wide	
100% polyurethane/silicone	
Ink-resistant protective top coat	
Polyester backing	
82T12/466392-012	Iris
82T13/466392-013	Nocturnal
82T14/466392-014	Fluid
82T15/466392-015	Eden
82T16/466392-016	Galactic
82T17/466392-017	Shoreline
82T18/466392-018	Jade
82T19/466392-019	Garden
82T20/466392-020	Botanic
82T21/466392-021	Chartreuse
82T23/466392-023	Lyric
82T24/466392-024	Turmeric
82T25/466392-025	Bengal
82T26/466392-026	Core
82T27/466392-027	Mantle
82T28/466392-028	Sorbet
82T32/466392-032	Oak
82T33/466392-033	Castle
82T34/466392-034	Follow
82T35/466392-035	Elixir
82T36/466392-036	Charm
82T37/466392-037	Descend
82T38/466392-009	Sketch
82T39/466392-010	Glacier
82T40/466392-031	Fortress
82T41/466392-030	Lotus
82T42/466392-001	Coconut
82T43/466392-011	Cobblestone
82T44/466392-029	Bloom
82T45/466392-022	Crepe
82T46/466392-006	Hickory
82T47/466392-007	Constellation
82T48/466392-008	Labyrinth
82T49/466392-002	Vibe
82T50/466392-003	Stampede
82T51/466392-004	Lumber
82T52/466392-005	Gingerbread

Appendix: Textile Colors

- Maharam textiles are on assigned lead times [A](#).
- Fabric numbers are listed as Herman Miller fabric number/Maharam fabric number.

Price category F continued on next page

Textile Colors

continued

Price Category F

continued

Appendix: Textile Colors

Brindle - Maharam	
Ancillary/Seating	
58" wide	
100% polyester	
PFOA-free stain resistant	
Acrylic backing	
87101/466418-001	Calico
87102/466418-002	Mauve
87103/466418-003	Torch
87104/466418-004	Burnt
87105/466418-005	Barn
87106/466418-006	Pharaoh
87107/466418-007	Sandbur
87108/466418-008	Jungle
87109/466418-009	Inland
87110/466418-009	Seagrass
87111/466418-009	Watercolor
87112/466418-009	Aquarium
87113/466418-009	Drill

Chime - Maharam	
Ancillary	
54" wide	
100% vinyl	
V9M3/465350-003	Morel
V9MB/465350-011	Tranquil
V9M/465350-020	Slate
V9MV/465350-031	Verve
V9MW/465350-032	Understory

Conduit - Maharam	
Ancillary/Seating	
58" wide	
100% polyester	
PFOA-free stain resistant	
Acrylic backing	
87Z01/466428-001	Space
87Z02/466428-002	Syrup
87Z03/466428-003	Nimbus
87Z04/466428-004	Greystone
87Z05/466428-005	Fawn
87Z06/466428-006	Ghost
87Z07/466428-007	Caribbean
87Z08/466428-008	Canal
87Z09/466428-009	Bonfire

Emit - Maharam	
Workspaces	
54" wide	
55% post-industrial recycled polyester	
45% post-consumer recycled polyester	
PFOA-free stain resistant	
8EX01/466378-001	Wed
8EX02/466378-002	Zebra
8EX03/466378-003	Chiffon
8EX05/466378-005	Nectar
8EX06/466378-006	Elk
8EX08/466378-008	Goldenrod
8EX09/466378-009	Beached
8EX10/466378-010	Samba
8EX11/466378-011	Nest
8EX14/466378-014	Groove
8EX17/466378-017	Haiku
8EX18/466378-018	Bluefin
8EX19/466378-019	Flow
8EX20/466378-020	Xenon
8EX21/466378-021	Artem
8EX22/466378-022	Zen
8EX25/466378-025	Limeade

Instill - Maharam	
Ancillary/Seating	
54" wide	
100% polyurethane	
Ink-resistant protective top coat	
Polyester backing	
74M01/466351-001	Page
74M02/466351-002	Limestone
74M03/466351-003	Bobwhite
74M04/466351-004	Loafer
74M07/466351-007	Shaker
74M08/466351-008	Doe
74M09/466351-009	Ride
74M10/466351-010	Squire
74M11/466351-011	Tannin
74M12/466351-012	Vitis
74M14/466351-014	Quail
74M15/466351-015	Brittanic
74M16/466351-016	Narwhal
74M18/466351-018	Stowaway
74M19/466351-019	Koala
74M20/466351-020	Dorsal
74M21/466351-021	Stealth
74M22/466351-022	Mosey
74M23/466351-023	Beachfront
74M24/466351-024	Discovery
74M25/466351-025	Grasp
74M26/466351-026	Arboreous
74M27/466351-027	Yearling
74M28/466351-028	Allele
74M29/466351-029	Eager
74M30/466351-030	Rise
74M31/466351-031	Latte
74M32/466351-032	Compose
74M33/466351-033	Furrow
74M34/466351-034	Tenor
74M35/466351-035	Annatto
74M36/466351-036	Together
74M37/466351-037	Intention
74M38/466351-038	Overnight
74M39/466351-039	Icecap
74M40/466351-040	Metamorphic
74M41/466351-041	Anthracite

Keen - Maharam	
Ancillary/Seating	
54" wide	
61% polyester	
39% polyolefin	
PFOA-Free stain resistant	
Acrylic backing	
89N01/466433-001	Gaur
89N02/466433-002	Lock
89N03/466433-003	Elk
89N04/466433-004	Oatmeal
89N05/466433-005	Lakefront
89N06/466433-006	Argent
89N07/466433-007	Coyote
89N08/466433-008	Eventide
89N09/466433-009	Canal
89N10/466433-010	Rosemary
89N11/466433-011	Herb
89N12/466433-012	Ruby
89N13/466433-013	Loganberry

Ledger - Maharam	
Ancillary/Seating	
54" wide	
100% polyurethane	
V9G1/463770-001	001
V9G2/463770-002	002
V9G3/463770-003	003
V9G4/463770-004	004
V9GG/463770-017	017
V9GQ/463770-025	025
V9GS/463770-026	026
V9GU/463770-028	028
V9GV/463770-029	029
V9GW/463770-030	030
V9GX/463770-031	031
V9GY/463770-032	032
V9G18/463770-042	042
V9G19/463770-043	043
V9G20/463770-044	044
V9G21/463770-045	045
V9G22/463770-046	046

Price category F continued on next page

- Maharam textiles are on assigned lead times [A](#).
- Fabric numbers are listed as Herman Miller fabric number/Maharam fabric number.

Textile Colors

continued

Price Category F

continued

Loop - Maharam	
Ancillary/Seating	
57" wide	
48% post-industrial recycled polyester	
26% polyester	
26% post-consumer recycled polyester	
PFOA-Free stain resistant	
Acrylic Backing	
ZLL01/466469-001	Opossum
ZLL02/466469-002	Foundation
ZLL03/466469-003	Naval
ZLL04/466469-004	Buoyant
ZLL05/466469-005	Mockingbird
ZLL06/466469-006	Dynasty
ZLL07/466469-007	Zori
ZLL08/466469-008	Wildfire
ZLL09/466469-009	Floral
ZLL10/466469-010	Penguin

Multiply - Maharam	
Ancillary/Seating	
58" wide	
57% post-consumer recycled polyester	
43% post-industrial recycled polyester	
PFOA-Free stain resistant	
Acrylic Backing	
82A01/466341-001	Winter
82A02/466341-002	Encore
82A03/466341-003	Swing
82A04/466341-004	Contrast
82A05/466341-005	Sterling
82A06/466341-006	Daze
82A07/466341-007	Sway
82A08/466341-008	Sailor
82A09/466341-009	Mystique
82A10/466341-010	Deep
82A11/466341-011	Craft
82A12/466341-012	Town
82A13/466341-013	Limit
82A14/466341-014	Tamale

Pitch - Maharam	
Ancillary	
54" wide	
100% vinyl	
ZPC04/466186-004	Pollen
ZPC07/466186-007	Apple
ZPC11/466186-011	Voyage
ZPC12/466186-012	Turquoise
ZPC14/466186-014	Inlet
ZPC15/466186-015	Captain
ZPC16/466186-016	Aura
ZPC17/466186-017	Coastal
ZPC18/466186-018	Fog
ZPC19/466186-019	Coal
ZPC21/466186-021	Mulberry
ZPC24/466186-024	Flame
ZPC26/466186-026	Tumbleweed
ZPC29/466186-029	Subtle
ZPC30/466186-030	Buff

Pepper - Maharam	
Ancillary/Seating	
58" wide	
49% polyester	
41% post-industrial recycled polyester	
10% post-consumer recycled polyester	
PFOA-Free stain resistant	
Acrylic Backing	
8LW01/466486-001	Dojo
8LW02/466486-002	Marengo
8LW03/466486-003	Harlequin
8LW04/466486-004	Pavlova
8LW06/466486-006	Achiote
8LW07/466486-007	Essence
8LW08/466486-008	Genome
8LW09/466486-009	Myriad
8LW10/466486-010	Terrarium

Scuba - Maharam	
Ancillary	
54" wide	
100% polyurethane	
V9B1/464930-001	Vanilla
V9B5/464930-005	Chinchilla
V9B6/464930-006	Mahogany
V9B7/464930-007	Jet
V9B8/464930-008	Charcoal
V9B9/464930-009	Dolphin
V9BA/464930-010	Drizzle
V9BC/464930-012	Conifer
V9BD/464930-013	Bottle
V9BF/464930-015	Tourmaline
V9BG/464930-016	Sapphire
V9BH/464930-017	Electric
V9BL/464930-020	Cabernet
V9BM/464930-021	Brick
V9BN/464930-022	Coral
V9BP/464930-023	Autumn

Strum - Maharam	
Ancillary/Seating	
54" wide	
100% polyurethane with silane-based antimicrobial	
Z3301/466122-001	Overcast
Z3302/466122-002	Ridge
Z3304/466122-004	Pigeon
Z3307/466122-007	Bur
Z3308/466122-008	Abalone
Z3312/466122-012	Lemongrass

Price Category G

Compound - Maharam	
Ancillary/Seating	
54" wide	
100% polyurethane with silane-based antimicrobial	
ZC201/466196-001	Quartz
ZC203/466196-003	Weathered
ZC204/466196-004	Cliff
ZC205/466196-005	Espresso
ZC206/466196-006	Smolder
ZC207/466196-007	Blaze
ZC208/466196-008	Mandarin
ZC209/466196-009	Maple
ZC210/466196-010	Perennial
ZC211/466196-011	Mountainside
ZC212/466196-012	Tundra
ZC213/466196-013	Manatee
ZC214/466196-014	Marine
ZC215/466196-015	Twilight
ZC216/466196-016	Shelter
ZC217/466196-017	Vessel
ZC218/466196-018	Smoke
ZC219/466196-019	Fog

Fluent Crypton - Maharam	
Ancillary	
54" wide	
52% polyester	
31% post-industrial recycled polyester	
17% post-consumer recycled polyester	
ZFC01/466073-001	Lynx
ZFC12/466073-012	Bayou
ZFC13/466073-013	Bottle
ZFC14/466073-014	Cadet
ZFC22/466073-022	Turf
ZFC24/466073-024	Steady

Price category G continued on next page

Appendix: Textile Colors

- Maharam textiles are on assigned lead times [A](#).
- Fabric numbers are listed as Herman Miller fabric number/Maharam fabric number.

Textile Colors

continued

Appendix: Textile Colors

Price Category G

continued

Fold - Maharam	
Seating	
54" wide	
100% polyurethane	
Polyester backing	
ZF101/466292-001	Jet
ZF102/466292-002	Chalk
ZF103/466292-003	Smoke
ZF105/466292-005	Fatigue
ZF106/466292-006	Splash
ZF107/466292-007	Apple
ZF108/466292-008	Moss
ZF110/466292-010	Midnight

Gild - Maharam	
Ancillary/Seating	
54" wide	
100% non-phthalate vinyl	
Ink-resistant protective top coat	
Polyester backing	
8AR01/466432-005	Grapevine
8AR02/466432-009	Frosting
8AR03/466432-007	Smokey
8AR04/466432-003	Skylight
8AR05/466432-011	Sandstone
8AR06/466432-004	Hurricane
8AR07/466432-002	Wreath
8AR08/466432-001	Rainforest
8AR09/466432-012	Fudge
8AR10/466432-010	Lantern
8AR11/466432-006	Planet
8AR12/466432-008	Reflection

Pare - Maharam	
Ancillary/Seating	
54" wide	
52% wool	
26% polyester	
22% nylon	
PFOA-free stain resistant finish	
ZPR01/466359-001	Polaris
ZPR04/466359-004	Fresco
ZPR06/466359-006	Wink
ZPR07/466359-007	Concord
ZPR08/466359-008	Strawberry
ZPR09/466359-009	Solar
ZPR10/466359-010	Amulet
ZPR11/466359-011	Zest
ZPR12/466359-012	Elmwood
ZPR13/466359-013	Thyme
ZPR17/466359-017	Blueberry

Runner - Maharam	
Ancillary/Seating	
54" wide	
57% post-industrial recycled polyester	
43% post-consumer recycled polyester	
ZRF01/466108-001	Bluff
ZRF03/466108-003	Grove
ZRF04/466108-004	Starboard
ZRF05/466108-005	Plot
ZRF06/466108-006	Carousel

Sudden - Maharam	
Ancillary	
54" wide	
100% polyurethane	
ZSD02/463000-002	002
ZSD03/463000-003	003
ZSD05/463000-005	005
ZSD06/463000-006	006
ZSD07/463000-007	007
ZSD08/463000-008	008
ZSD09/463000-009	009
ZSD10/463000-010	010
ZSD11/463000-011	011
ZSD13/463000-013	013
ZSD15/463000-015	015
ZSD16/463000-016	016
ZSD17/463000-017	017
ZSD18/463000-018	018
ZSD19/463000-019	019
ZSD20/463000-020	020
ZSD24/463000-024	024
ZSD27/463000-027	027
ZSD36/463000-036	036

Price Category H

Anagram - Maharam	
Ancillary	
54" wide	
42% cotton	
32% polyester	
26% nylon	
ZAN01/466067-001	Quarry
ZAN02/466067-002	Hush
ZAN03/466067-003	Electric
ZAN04/466067-004	Range
ZAN05/466067-005	Settle

Circles - Maharam	
Ancillary/Seating	
55" wide	
70% cotton	
30% polyester	
ZT01/458310-001	Khaki
ZT02/458310-002	Fatigue
ZT03/458310-003	Document
ZT04/458310-004	Engine

Dot Pattern - Maharam	
Ancillary/Seating	
55" wide	
71% cotton	
29% polyester	
ZK01/458300-001	Document
ZK02/458300-002	Taupe
ZK04/458300-004	Red
ZK05/458300-005	Navy

Mechanism - Maharam	
Ancillary	
54" wide	
100% polyester	
ZMC01/465952-001	Mercury
ZMC10/465952-010	Pearl
ZMC11/465952-011	Bronze
ZMC13/465952-013	Titanium
ZMC15/465952-015	Tangerine
ZMC17/465952-017	Sprout

Price category H continued on next page

- Maharam textiles are on assigned lead times [A](#).
- Fabric numbers are listed as Herman Miller fabric number/Maharam fabric number.

Textile Colors

continued

Price Category H

continued

Mister – Maharam	
Ancillary	
54" wide	
67% solution-dyed acrylic	
33% solution-dyed polyester	
ZMG01/466178-001 Breeze	
ZMG04/466178-004 Enliven	
ZMG05/466178-005 Notice	
ZMG06/466178-006 Azurite	

Regatta – Maharam	
Ancillary	
54" wide	
65% solution-dyed acrylic	
35% solution-dyed polyester	
ZRT01/466189-001 Drift	
ZRT02/466189-002 Parasol	
ZRT04/466189-004 Swell	

Small Dot Pattern – Maharam	
Ancillary/Seating	
55" wide	
71% cotton	
29% polyester	
ZL01/458320-001 Document	
ZL02/458320-002 Sand	
ZL03/458320-003 Khaki	
ZL04/458320-004 Taupe	
ZL05/458320-005 Charcoal	
ZL06/458320-006 Document	
Reverse	
ZL07/458320-007 Red	
ZL08/458320-008 Yellow	
ZL09/458320-009 Green	

Price Category I

Colorwheel – Maharam	
Ancillary	
54" wide	
62% cotton	
38% solution-dyed post-industrial recycled nylon	
ZCW02/466163-002 Pumice	
ZCW03/466163-003 Viridian	
ZCW06/466163-006 Charcoal	
ZCW07/466163-007 Carbon	

Cursive – Maharam	
Ancillary/Seating	
54" wide	
67% solution-dyed acrylic	
33% solution-dyed polyester	
PFOA-Free stain resistant	
7CW01/466335-001 Fast	
7CW03/466335-003 Beachcomb	
7CW05/466335-005 Swift	
7CW07/466335-007 Inkwell	
7CW08/466335-008 Rubber	

Passage - Maharam	
Ancillary	
54" wide	
100% polyester	
59P01/466614-001 Mirage	
59P02/466614-002 Poolside	
59P03/466614-003 Cascade	
59P04/466614-004 Lacinato	
59P05/466614-005 Overstory	
59P06/466614-006 Celadon	
59P07/466614-007 Echo	
59P08/466614-008 Bentonite	
59P09/466614-009 Buttercup	
59P10/466614-010 Maple	
59P11/466614-011 Blossom	
59P12/466614-012 Cloudberry	
59P13/466614-013 Contessa	
59P14/466614-014 Claret	
59P15/466614-015 Katana	

Study - Maharam	
Ancillary/Seating	
54" wide	
73% solution-dyed acrylic	
27% solution-dyed polyester	
ZSY01/466269-001 001	
ZSY02/466269-002 002	
ZSY03/466269-003 003	
ZSY04/466269-004 004	
ZSY05/466269-005 005	

Tracery – Maharam	
Ancillary	
52" wide	
34% solution-dyed nylon	
26% wool	
21% polyester	
19% cotton	
acrylic backing	
PFOA-free stain resistant finish	
ZT501/466372-001 Birch	
ZT502/466372-002 Sterling	
ZT503/466372-003 Flint	
ZT504/466372-004 Indigo	
ZT505/466372-005 Arctic	
ZT506/466372-006 Kelp	
ZT507/466372-007 Melon	
ZT508/466372-008 Poppy	
ZT509/466372-009 Copper	
ZT510/466372-010 Papaya	
ZT511/466372-011 Sepia	

Price Category J

Fluted Silk – Maharam	
Ancillary	
54" wide	
85% silk	
8% cotton	
7% acrylic	
ZFK02/465982-002 Tarnish	
ZFK05/465982-005 Calm	
ZFK06/465982-006 Flaxen	
ZFK10/465982-010 Noticed	
ZFK11/465982-011 Moody	
ZFK12/465982-012 Constant	
ZFK13/465982-013 Seed	
ZFK14/465982-014 Eternal	
ZFK15/465982-015 Honor	
ZFK17/465982-017 Cranach	
ZFK20/465982-020 Discreet	

Mikado – Maharam	
Ancillary	
54" wide	
79% cotton	
21% polyester	
V1901/459330-001 Umber	
V1902/459330-002 Orange	
V1903/459330-003 Ultramarine	
V1904/459330-004 Pink	
V1905/459330-005 Sepia	

Price category J continued on next page

- Maharam textiles are on assigned lead times [A](#).
- Fabric numbers are listed as Herman Miller fabric number/Maharam fabric number.

Textile Colors

continued

Appendix: Textile Colors

Price Category J

continued

Trestle - Maharam	
Ancillary	
54" wide	
36% acrylic	
32% wool	
23% cotton	
9% polyester	
3WG01/466613-001	Loam
3WG02/466613-002	Rift
3WG03/466613-003	Fuse
3WG04/466613-004	Cumulus
3WG05/466613-005	Strand
3WG06/466613-006	Pomelo
3WG07/466613-007	Tawny
3WG08/466613-008	Sunstone
3WG09/466613-009	Kindling
3WG10/466613-010	Sidecar
3WG11/466613-011	Beak
3WG12/466613-012	Ficus
3WG13/466613-013	Hinge
3WG14/466613-014	Bluefish
3WG15/466613-015	Oblivion

Price Category K

Checker – Maharam	
Ancillary	
55" wide	
77% cotton	
23% polyester	
V1201/459830-001	Emerald Light/ Ivory
V1204/459830-004	Ultramarine/ Emerald
V1206/459830-007	Sienna Dark/ Khaki
V1207/459830-008	Black/White
V1209/459830-009	Ultramarine/ Turquoise
V1210/459830-010	Blue Gray/ Emerald
V1211/459830-011	Olive/Pink
V1212/459830-012	Magenta/ Orange
V1213/459830-013	Crimson/ Orange

Checker Split – Maharam	
Ancillary	
55" wide	
77% cotton	
23% polyester	
V1301/460290-01	Black/White

Double Triangles – Maharam	
Ancillary	
55" wide	
77% cotton	
23% polyester	
V1401/459840-001	Black/White

Facets – Maharam	
Ancillary	
55" wide	
77% cotton	
23% polyester	
V1501/459850-001	Black/White

Isa – Maharam	
Ancillary	
59" wide	
85% wool	
15% nylon	
VKZ01/466624-001	Bashful
VKZ02/466624-002	Median
VKZ03/466624-003	Observe
VKZ04/466624-004	Plains
VKZ05/466624-005	Drawn
VKZ06/466624-006	Connect
VKZ07/466624-007	Fennel
VKZ08/466624-008	Skyward
VKZ09/466624-009	Oceanic
VKZ10/466624-010	Neptune
VKZ11/466624-011	Sprint
VKZ12/466624-012	Ledge
VKZ13/466624-013	Surround
VKZ14/466624-014	Foretell
VKZ15/466624-015	Lory
VKZ16/466624-016	Dear
VKZ17/466624-017	Foxtrot
VKZ18/466624-018	Sincere
VKZ19/466624-019	Begonia

Optik – Maharam	
Ancillary	
55" wide	
76% cotton	
24% polyester	
ZQP01/459960-001	Sun Yellow/ Orange
ZQP06/459960-006	White/Black

Unisol – Maharam	
Ancillary	
55" wide	
61% rayon	
21% polyester	
18% cotton	
ZUN01/461160-001	Black/ White

Price Category L

Exaggerated Plaid – Maharam	
Ancillary	
59" wide	
100% wool	
ZEP01/466039-001	Glen
ZEP02/466039-002	Brae
ZEP03/466039-003	Firth

Geometri – Maharam	
Ancillary	
55" wide	
77% cotton	
23% polyester	
ZGM02/459970-002	Red/ Carmine
ZGM03/459970-003	Lilac/Blue
ZGM04/459970-004	White/ Black

Jacobs Coat – Maharam	
Ancillary	
54" wide	
92% wool	
8% nylon	
V1601/462270-001	Multicolored Bright *
V1602/462270-002	Multicolored Neutral

* Color available on Girard Color Wheel Ottoman.

Millerstripe – Maharam	
Ancillary	
54" wide	
92% wool	
8% rayon	
V1701/462250-001	Multicolored Bright
V1702/462250-002	Multicolored Neutral

Price category L continued on next page

- Maharam textiles are on assigned lead times **A**.
- Fabric numbers are listed as Herman Miller fabric number/Maharam fabric number.

Textile Colors

continued

Price Category L

continued

Minicheck - Maharam
Seating
55" wide
78% cotton
22% polyester
PFOA-Free stain resistant finish
ZMK01/466268-001 Black/ White

Monk's Wool – Maharam
Ancillary
54" wide
96% wool
4% nylon
ZMW01/457301-001 Tusk
ZMW03/457301-003 Slate
ZMW05/457301-005 Cherokee

Pebble Wool – Maharam
Ancillary
54" wide
90% wool
10% nylon
ZPW01/457401-001 Birch
ZPW10/457401-010 Cottage
ZPW13/457401-013 Eggshell
ZPW14/457401-014 Whisper
ZPW15/457401-015 Ceramic
ZPW16/457401-016 Seamist
ZPW17/457401-017 Armory
ZPW18/457401-018 Glaze
ZPW19/457401-019 Cordial

Pebble Wool Multi – Maharam
Ancillary
54" wide
97% wool
3% nylon
ZPM01/461200-001 Fawn
ZPM02/461200-002 Slate
ZPM05/461200-005 Moss
ZPM06/461200-006 Tabasco

Quatrefoil – Maharam
Ancillary
54" wide
75% cotton
25% nylon
V2101/459350-001 Silver
V2102/459350-002 Pink
V2103/459350-003 Crimson
V2104/459350-004 Emerald
V2105/459350-005 Violet

Repeat Classic Stripe – Maharam
Ancillary
55" wide
47% cotton
27% rayon
26% polyester
ZRS01/462170-001 Inca
ZRS02/462170-002 Pistachio
ZRS03/462170-003 Poppy
ZRS04/462170-004 Cadet
ZRS05/462170-005 Peacock

Repeat Dot Ring – Maharam
Ancillary
55" wide
75% cotton
25% polyester
ZRR01/462150-001 Gold
ZRR04/462150-004 Pink
ZRR05/462150-005 Coral
ZRR07/462150-007 Gold
Reverse
ZRR10/462150-010 Pink
Reverse
ZRR11/462150-011 Coral
Reverse

Stripes - Maharam
Ancillary
56" wide
92% wool
8% nylon
ZSP01/463980-001 001
ZSP02/463980-002 002
ZSP03/463980-003 003
ZSP04/463980-004 004
ZSP05/463980-005 005
ZSP06/463980-006 006
ZSP07/463980-007 007
ZSP08/463980-008 008
ZSP09/463980-009 009
ZSP10/463980-010 010

Toostripe – Maharam
Ancillary
54" wide
92% wool
8% nylon
V2201/462260-001 Orange Dark/ Crimson Dark
V2202/462260-002 Black/ Raw Umber
V2203/462260-003 Ochre Dark/ Sienna

Price Category M

Fruit - Maharam
Seating
54" wide
55% cotton
32% nylon
13% post-consumer recycled polyester
PFOA-Free stain resistant finish
Acrylic backing
ZF201/466262-001 Opal
ZF202/466262-002 Lime
ZF203/466262-003 Olive
ZF204/466262-004 Sky
ZF207/466262-007 Russet

Names – Maharam
Ancillary
55" wide
73% cotton
27% polyester
V1801/462510-001 Crimson On White
V1802/462510-002 Ultramarine On White
V1803/462510-003 Black On White

Price category M continued on next page

- Maharam textiles are on assigned lead times A.
- Fabric numbers are listed as Herman Miller fabric number/Maharam fabric number.

Textile Colors

continued

Appendix: Textile Colors

Price Category M

continued

Ottoman Stripe – Maharam

Ancillary
58" wide
92% wool
8% nylon
ZQN01/466142-001 Brass
ZQN02/466142-002 Cocoa
ZQN03/466142-003 Dusk
ZQN04/466142-004 Pistachio
ZQN05/466142-005 Apricot

Pressed Plaid – Maharam

Ancillary
54" wide
100% wool
T1101/466181-001 001
T1102/466181-002 002
T1103/466181-003 003
T1104/466181-004 004
T1105/466181-005 005
T1106/466181-006 006

Wool Striae – Maharam

Ancillary
54" wide
100% wool
T1201/466184-001 001
T1202/466184-002 002
T1203/466184-003 003
T1204/466184-004 004
T1205/466184-005 005
T1206/466184-006 006
T1207/466184-007 007

Price Category N

Alpaca Epinglé - Maharam

Ancillary
55" wide
100% alpaca
ZAE01/465902-001 Vellum
ZAE02/465902-002 Slate
ZAE06/465902-006 Graphite
ZAE07/465902-007 Beignet

Alpaca Velvet - Maharam

Ancillary
54" wide
100% alpaca
ZAV01/465901-001 Alpine
ZAV06/465901-006 Charcoal
ZAV07/465901-007 Pewter
ZAV08/465901-008 Squash
ZAV09/465901-009 Wallaby
ZAV10/465901-010 Brunia

Bespoke Stripe - Maharam

Ancillary
56" wide
100% wool
ZBP01/463540-001 Navy
ZBP02/463540-002 Tobacco
ZBP03/463540-003 Chocolate
ZBP04/463540-004 Charcoal
ZBP05/463540-005 Black
ZBP06/463540-006 Pewter

Herringbone Stripe - Maharam

Ancillary
57" wide
100% wool
ZKP01/465945-001 Granite
ZKP02/465945-002 Espresso
ZKP03/465945-003 Graphite
ZKP04/465945-004 Indigo
ZKP05/465945-005 Raven

Point – Maharam

Ancillary
53" wide
97% rayon
3% nylon
ZPT01/466090-001 Ivory and Ember
ZPT02/466090-002 Black and Coral
ZPT03/466090-003 Slate and Khaki
ZPT04/466090-004 Black and Cobalt
ZPT05/466090-005 Black and Khaki
ZPT06/466090-006 Slate and Mandarin
ZPT07/466090-007 Slate and Black
ZPT08/466090-008 Brick and Greige
ZPT09/466090-009 Gold and Black
ZPT10/466090-010 Greige and Peat
ZPT11/466090-011 Peat and Mandarin
ZPT12/466090-012 Crimson
ZPT13/466090-013 Mandarin
ZPT14/466090-014 Citrus
ZPT15/466090-015 Grass
ZPT16/466090-016 Cyan
ZPT17/466090-017 Cobalt

Wool Velvet - Maharam

Ancillary
54" wide
100% wool
ZWV01/466120-001 Plush
ZWV02/466120-002 Subdue
ZWV03/466120-003 Flagstone
ZWV04/466120-004 Nori
ZWV06/466120-006 Bridle
ZWV07/466120-007 Covert
ZWV08/466120-008 Gateway

Price Category O

Bavaria Stripe – Maharam

Ancillary
55" wide
77% polyester
23% cotton
ZBS02/466161-002 Unique

- Maharam textiles are on assigned lead times. ^A
- Fabric numbers are listed as Herman Miller fabric number/Maharam fabric number.

Textile Colors

continued

Price Category P

Big Stripe – Maharam	
Ancillary	
55" wide	
92% wool	
8% nylon	
ZBR01/466174-001	Peacock
ZBR02/466174-002	Spring
ZBR03/466174-003	Umber
ZBR04/466174-004	Poppy
ZBR05/466174-005	Cobalt

Epinglé Stripe - Maharam	
Ancillary	
50" wide	
100% cotton	
ZES01/466007-001	Caramel
ZES02/466007-002	Lead
ZES03/466007-003	Violet
ZES04/466007-004	Mahogany
ZES05/466007-005	Olive

Layers Garden – Maharam	
Ancillary	
52" wide	
96% wool	
3% nylon	
1% polyester	
ZLY01/465916-001	Ivy/Bronze
ZLY02/465916-002	Putty/ Turquoise
ZLY03/465916-003	Pewter/ White
ZLY04/465916-004	Chocolate/ Lilac
ZLY05/465916-005	Peat/Copper

Layers Park – Maharam	
Ancillary	
52" wide	
95% wool	
3% nylon	
2% polyester	
ZLP01/465918-001	Ash/Snow
ZLP02/465918-002	Mineral/Sky
ZLP03/465918-003	Poppy/ Melon
ZLP04/465918-004	Indigo/ White
ZLP05/465918-005	Earth/Cobalt

Layers Vineyard Large – Maharam	
Ancillary	
52" wide	
95% wool	
3% nylon	
2% polyester	
ZLV01/465921-001	Ivory/Onyx
ZLV02/465921-002	Slate/Azure
ZLV03/465921-003	Loden/Sky
ZLV04/465921-004	Taupe/ Crimson
ZLV05/465921-005	Black/ Mahogany

Layers Vineyard Small – Maharam	
Ancillary	
52" wide	
92% wool	
5% polyester	
3% nylon	
ZLS01/465920-001	Ochre/White
ZLS02/465920-002	Scarlet/ Peony
ZLS03/465920-003	Taupe/Violet
ZLS04/465920-004	Jade/ Turquoise
ZLS05/465920-005	Ginger/Rose

Mohair Supreme - Maharam	
Ancillary	
54" wide	
100% mohair	
ZMS02/451801-072	Stonehenge
ZMS06/451801-112	Slate *
ZMS07/451801-113	Rich Chocolate *
ZMS09/451801-126	Cayenne
ZMS10/451801-127	Cognac
ZMS12/451801-129	Peat *
ZMS15/451801-133	Abyss
ZMS16/451801-134	Intrigue
ZMS18/451801-136	Lupine *
ZMS28/451801-146	League
ZMS29/451801-147	Armory *
ZMS32/451801-150	Capiz
ZMS33/451801-151	Underneath
ZMS34/451801-152	Crescent
ZMS35/451801-153	National
ZMS36/451801-154	Rooftop
ZMS37/451801-155	Skewer
ZMS38/451801-156	Party
ZMS39/451801-157	Keepsake
ZMS40/451801-158	Travel
ZMS41/451801-159	Estate
ZMS42/451801-160	Grassland
ZMS43/451801-161	Limoncello
ZMS44/451801-162	Mango
ZMS45/451801-163	Doll
ZMS46/451801-164	Carousel
ZMS47/451801-165	Palette
ZMS48/451801-166	Brandy
ZMS49/451801-167	Aristocrat
ZMS50/451801-168	Soulmate
ZMS51/451801-169	Rosette
ZMS52/451801-170	Aviator
ZMS53/451801-171	Penny

* Colors available on Eames Lounge Chair and Ottoman.

Price Category Q

A Band Apart – Maharam	
Ancillary	
56" wide	
75% polyester	
25% cotton	
ZAB01/466000-001	Unique

Brushed Camel – Maharam	
Ancillary	
58" wide	
100% baby camel hair	
ZBA01/465977-001	Albino
ZBA02/465977-002	Natural

Deconstructed Rose – Maharam	
Ancillary	
55" wide	
65% polyester	
32% cotton	
3% rayon	
ZDS01/466086-001	Golden
ZDS02/466086-002	Vivid
ZDS03/466086-003	Earthen

Massive Paisley – Maharam	
Ancillary	
57" wide	
76% polyester	
24% cotton	
ZMV01/465915-001	Ash
ZMV03/465915-003	Cardinal
ZMV06/465915-006	Night

The Firm – Maharam	
Ancillary	
56" wide	
75% polyester	
25% cotton	
ZTF03/465999-003	Unique

- Maharam textiles are on assigned lead times. ^A
- Fabric numbers are listed as Herman Miller fabric number/Maharam fabric number.

Textile Colors

continued

Appendix: Textile Colors

Price Category R

Borders – Maharam	
Ancillary	
53" wide	
98% wool	
2% polyester	
ZBB01/466082-001 Natural	
ZBB02/466082-002 Greige	
ZBB03/466082-003 Charcoal	
ZBB04/466082-004 Walnut	

Stow Leather - Maharam	
Ancillary	
approx. 50 sq. ft. per hide	
100% leather	
protective top coat	
ZSV01/700014-001 Opera	
ZSV02/700014-002 Japonica	
ZSV03/700014-003 Masquerade	
ZSV04/700014-004 Laguna	
ZSV05/700014-005 Jettison	
ZSV06/700014-006 Razor	
ZSV07/700014-007 Holiday	
ZSV08/700014-008 Patchouli	
ZSV09/700014-009 Macrame	
ZSV10/700014-010 Grace	
ZSV11/700014-011 Seraphim	
ZSV12/700014-012 Ricotta	
ZSV13/700014-013 Neroli	
ZSV14/700014-014 Sultana	
ZSV15/700014-015 Sundance	
ZSV16/700014-016 Quince	
ZSV17/700014-017 Babka	
ZSV18/700014-018 Maitake	
ZSV19/700014-019 Mercer	
ZSV20/700014-020 Gaucho	
ZSV21/700014-021 Chia	
ZSV22/700014-022 Vanguard	
ZSV23/700014-023 Zone	
ZSV24/700014-024 Zeppelin	

Stow Leather <i>continued</i>	
ZSV25/700014-025 Clandestine	
ZSV26/700014-026 Raven	
ZSV27/700014-027 Cabana	
ZSV28/700014-028 Rime	
ZSV29/700014-029 Forsythia	
ZSV30/700014-030 Panthera	
ZSV31/700014-031 Dune	
ZSV32/700014-032 Madera	
ZSV33/700014-033 Russet	
ZSV34/700014-034 Gala	
ZSV35/700014-035 Heron	

Price Category S

Bavaria – Maharam	
Ancillary	
55" wide	
73% polyester	
27% cotton	
ZBV01/466162-001 Unique	

Price Category T

All Grain Leather – Edelman	
Ancillary	
approx. 50 sq. ft. per hide	
100% full-grain Aniline-dye cowhide	
VB01/AG01	Pitch Brown
VB02/AG02	White
VB03/AG03	Cloud
VB04/AG04	Shadow
VB05/AG05	Black
VB06/AG06	Baked Bean
VB07/AG07	Mildew
VB08/AG08	Soot
VB09/AG09	Blue Jeans
VB10/AG10	Merlot
VB11/AG11	Nutmeg
VB12/AG12	Butter
VB13/AG13	Cherry
VB14/AG14	Burnt Orange
VB15/AG15	Whiskey
VB17/AG17	Raw Silk
VB18/AG18	Balsa
VB19/AG19	Naturale
VB21/AG21	Greige
VB22/AG27	Latte
VB23/AG28	Coral
VB24/AG29	Rose
VB25/AG30	Zinnia
VB26/AG31	Iris
VB27/AG32	Daffodil

Hours – Maharam	
Ancillary	
56" wide	
95% wool	
3% nylon	
2% rayon	
ZKR01/466092-001	Day
ZKR02/466092-002	Night

- Maharam textiles are on assigned lead times. ^A
- Fabric numbers are listed as Herman Miller fabric number/Maharam fabric number.

Textile Colors

continued

Price Category U	Price Category V-W	Price Category X	Price Category Y
<p>Layers Garden Double – Maharam</p> <p>Ancillary 52” wide 96% wool 3% nylon 1% polyester</p> <p>ZLD01/465917-001 Ash/ Quartz/ Grass</p> <p>ZLD02/465917-002 Earth/ Chocolate/ Coral</p> <p>ZLD03/465917-003 Black/ Navy/ Cobalt</p>	<p>No fabrics available at this time.</p>	<p>Eden – Maharam</p> <p>Ancillary 56” wide 83% polyester 17% cotton</p> <p>ZED01/466258-001 001</p> <p>ZED02/466258-002 002</p> <p>ZED03/466258-003 003</p> <p>ZED04/466258-004 004</p> <p>ZED05/466258-005 005</p>	<p>Industry – Maharam</p> <p>Ancillary 55” wide 80% polyester 20% cotton</p> <p>ZND01/466255-001 001</p>
<p>Layers Park Double – Maharam</p> <p>Ancillary 52” wide 96% wool 3% nylon 1% polyester</p> <p>ZLB01/465919-001 Mineral/ Taupe/ Lemon</p> <p>ZLB02/465919-002 Sienna/ Ginger/ Rose</p> <p>ZLB03/465919-003 Black/ Peat/ Copper</p>		<p>Foliage – Maharam</p> <p>Ancillary 56” wide 75% polyester 25% cotton</p> <p>ZFG02/466257-002 002</p> <p>ZFG04/466257-004 004</p> <p>ZFG05/466257-005 005</p>	

Appendix: Textile Colors

- Maharam textiles are on assigned lead times. A
- Fabric numbers are listed as Herman Miller fabric number/Maharam fabric number.

Textile Colors

continued

Price Category Z

Agency – Maharam	
Ancillary	
55" wide	
75% polyester	
25% cotton	
ZAG02/466001-002	002
ZAG04/466001-004	004
ZAG05/466001-005	005
ZAG06/466001-006	006
ZAG07/466001-007	007
ZAG08/466001-008	008

Price Category 10M

Pace Leather – Maharam	
Ancillary	
approx. 50 sq. ft. per hide	
100% leather	
ZPA01/700011-001	Whisper
ZPA02/700011-002	Shy
ZPA03/700011-003	Granite
ZPA04/700011-004	Misty
ZPA05/700011-005	Studio
ZPA06/700011-006	Throne
ZPA07/700011-007	Proper
ZPA08/700011-008	Huron
ZPA09/700011-009	Darkroom
ZPA10/700011-010	Bark
ZPA11/700011-011	Raspberry
ZPA12/700011-012	Sangria
ZPA13/700011-013	Admiral
ZPA14/700011-014	Juniper
ZPA15/700011-015	Regal
ZPA16/700011-016	Vapor
ZPA17/700011-017	Valley
ZPA18/700011-018	Bushel
ZPA19/700011-019	Heirloom
ZPA20/700011-020	Palomino
ZPA21/700011-021	Bamboo
ZPA22/700011-022	Saffron
ZPA23/700011-023	Tearose
ZPA24/700011-024	Canyon
ZPA25/700011-025	Bistro
ZPA26/700011-026	Toffee
ZPA27/700011-027	Rodeo
ZPA28/700011-028	Mudslide
ZPA29/700011-029	Greige
ZPA30/700011-030	Reflection
ZPA31/700011-031	Pure
ZPA32/700011-032	Desert
ZPA33/700011-033	Griffin
ZPA34/700011-034	Urbane
ZPA35/700011-035	Woodrose

Appendix: Textile Colors

- Maharam textiles are on assigned lead times. ^A
- Fabric numbers are listed as Herman Miller fabric number/Maharam fabric number.

For more information about our products and services or to see a list of dealers, please visit us at HermanMiller.com or call (800) 851 1196.

© 2025 Herman Miller, Inc., Zeeland, Michigan

Distribution Rights

Working together since 1956, Herman Miller and Vitra are the authentic sources of designs by Charles and Ray Eames, Alexander Girard, and George Nelson. All the designs shown in this book are protected by law. Herman Miller has obtained all rights to make and sell these designs. Also, Herman Miller holds exclusive worldwide manufacturing and distribution rights for these products with the following exceptions:

Charles and Ray Eames, George Nelson, and Alexander Girard—Worldwide distribution rights for furniture in all areas except Europe and the Middle East. For those areas, please contact Vitra.

Isamu Noguchi—Worldwide distribution rights for the Noguchi Rudder Table. Distribution rights for the Noguchi Table in North America and Central America only. For all other areas, please contact Vitra.

Magis—Exclusive distribution rights in the US and Canada. For all other areas, please contact Magis.

© HermanMiller, 3D Intelligent, 8Z Pellicle, AO, Action Office, Aeron, Aside, Bubble Lamps, Canvas Office Landscape, Caper, Celle, Cosm, Co/Struc, Daisyone, Distil, Eames, Eco-Dematerialized, Embody, Envelop, Ethospace, Exclave, Fine-Tune, FlexFront, Flo, Formcoat, Formwork, Ground Cloth, Intent, Kinemat, Layout Studio, Lino, Live Unframed, Living Office, Maharam, Meridian, Mirra, Motia, Nelson, Pari, Pellicle, Perspectives, Plex, PostureFit, PostureFit SL, Public Office Landscape, Sayl, Setu, Striad, Tu, Ubi, Verus, Wishbone, Y-Tower and Zeph are among the registered trademarks of Herman Miller, Inc., and its owned subsidiaries.

™ About Face, AireWeave, Airia, Ambit, Asari Chair by HermanMiller, Backfit, Bubbletack, Burdick Group, Butterfly Back, Canvas Vista, Cellular Suspension, Commend, Compass, Connect, DOT, Duracare, Durawrap, EnhancedAccess, Everywhere, Flex-Edge, Flute, Harmonic, Headway, Herman Miller Select, Hopsak 2, Iota, Keyless Entry, Latitude, Logic Mini, Logic Power Access Solutions, Lyris, Lyris 2, Made-to-Measure Storage, Mora, Multiscrim, Nevi, OE1, OE1 Workspace Collection, Overlay, Pixelated Support, Pronta, Renew, Sense, Soft Pad, Stackable, Stackable Storage, Swoop, Thrive, Tone, TriFlex, Twist and Wireframe are among the trademarks of Herman Miller, Inc., and its owned subsidiaries.

SM Herman Miller Options is among the service marks of Herman Miller, Inc.

AAP™ is a trademark of Extron Electronics.

Alexander Girard® is a registered trademark of The Alexander Girard Estate.

Chemsur® is a registered trademark of Wilsonart International.

Corian® is a registered trademark of E. I. du Pont de Nemours and Company Corporation.

Crypton® is a registered trademark of Crypton, Inc.

DACRON® is a registered trademark of INVISTA S.a r.l.

Danzer® is a registered trademark of Danzer Holding AG.

Decora® is a registered trademark of Leviton Manufacturing Co., Inc.

Edelman® Leather is a registered trademark of Edelman Leather, Inc.

Extron® is a registered trademark of RGB Systems, Inc.

FENIX NTM® is a registered trademark of Arpa Industriale S.p.A.

FLEXNET™ is a trademark of Milliken & Company.

Floor Saver Glide® is a registered trademark of Carpin Manufacturing, Inc.

Forest Stewardship Council® is a registered trademark of the Forest Stewardship Council A.C. (FSC). We are FSC® certified (FSC® C102895).

FSC® is a registered trademark of the Forest Stewardship Council A.C. (FSC).

Geiger® is a registered trademark, and Bumper™, Saiba™, and Ward Bennett™ are trademarks, of Geiger International.

Hang-It-All® is a registered trademark of Lucia Eames Demetrios, d.b.a. Eames Office.

Holophane® is a registered trademark of Holophane.

Ingeo™ is a trademark of Cargill Dow LLC.

iPad® and Mac mini® are registered trademarks of Apple Inc.

Leviton® is a registered trademark of Leviton Manufacturing Co., Inc.

LifeSize® is a registered trademark of LifeSize Communications, Inc.

Lisocore® is a registered trademark of Pyrus Panels GmbH.

Logitech G® is a registered trademark of Logitech International S.A.

Magis®, Bombo®, and Me Too® are registered trademarks of Magis S.p.A.

MicrobeCare™ is a trademark of Parasol Medical LLC.

Microsoft® and Natural® Keyboard are registered trademarks of Microsoft Corporation.

Noguchi® and the Noguchi table configuration (trade dress) are registered trademarks, and Rudder Table™ is a trademark, of The Isamu Noguchi Foundation and Garden Museum.

Place Textiles® is a registered trademark of Place Textiles.

Sunbrella® is a registered trademark of Glen Raven, Inc.

SuperSeat™ is a trademark of Dahti Seating, a division of ITW.

Valor™ is among the trademarks owned by Nemschoff, Inc.