



Prices effective July 5, 2023

Published April 2024

# Fuld Nesting Chairs

<b>Introduction</b>	<b>page 2</b>
<b>Fuld Nesting Chairs</b>	<b>5</b>
<b>Appendices</b>	
20-Day or Less/Assigned Lead-Time Order Information	
Casters and Glides	
Textiles Application Chart-Seating	
Textile Colors	
<b>For the latest materials information, refer to the Materials pages on <a href="https://www.HermanMiller.com">HermanMiller.com</a>.</b>	

# Introduction

## A Note on the Organization of This Book

There are a few signals that will help you understand the organization of this book. Once you know them, you should be able to find your way around easily.

### Like a newspaper, this book is formatted with columns of text and illustrations that run vertically.

Information wraps from one column to the next and continues for as many pages as it needs to.

### Black bars are clues.

A black bar at the top of a page signals the start of information about a product.

This information is divided into two sections, each signaled by a black bar. Product Information includes a description, additional notes, and dimensional drawings. Specification Information, which always begins at the top of a column, includes a series of steps. Each step represents a decision you need to make in order to complete your product number. Steps must be followed sequentially. The number of pages needed to complete information on a product varies; some will be complete in one page; others may fill three or four pages. Just continue going through the steps until you run into the next product, signaled by the black bar at the top of the page.

Black tabs running along the outside edge of the page help you locate what section you are in or what section you want to go to. You can thumb forwards or backwards to find a section; tabs and text appear on both sides of the page.

The additional pages in the back of the book include the appendices and indices. They are signaled by a long black bar running along the outside edge of the page.

### The index is presented two ways.

The first index is in alphabetical order by product name. It can be helpful if you are new to the products and numbering scheme or if you are looking for a type of product, such as work chair or round table.

The second index is by product number. It lists, in alphanumeric order, the base product number, typically a five-digit number.

## General Information

This book is effective July 5, 2023, subject to change without notice. Products may be purchased from authorized Herman Miller dealers who will quote prices upon request. For more information about our products and services or to see a list of dealers, visit [www.HermanMiller.com](http://www.HermanMiller.com).

All prices are list prices. Additional services, such as planning services, design, storage, and installation, are not included and must be added to these prices when the additional services are requested.

Illustrations, specifications, and prices are based on the latest information at the time of publication. The right is reserved to make changes at any time without notice in prices, fabrics, finishes, materials, specifications, and models, and also to discontinue models and finishes.

Dimensions shown in the drawings are engineering drawing dimensions rounded up to the nearest  $\frac{1}{8}$ ". Product is shipped set up or knocked down. Products that include "Shipped knocked down" in the description require some assembly. If this statement does not appear in the description, the product is shipped assembled.

Service problems are normally handled by a Herman Miller authorized dealer. Where this cannot be accomplished on a local level, service problems should be referred to the Customer Care Representative for your region, Herman Miller, Inc., Zeeland, Michigan 49464.

### 20-Day or Less/Assigned Lead-Time Shipments

All products and options in this price book not designated by an Assigned Program icon  will ship in **20 business days or less** after being acknowledged by Herman Miller.

Products and options designated by an  are on the assigned lead-time program and may ship in 20 days, less than 20 days, or more than 20 days from order acknowledgement.





# Fuld Nesting Chair

NEC1P  
NEC2P

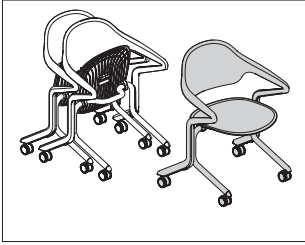

## Product Information

### Description

This nesting chair has a 1-piece frame including the arms made of 30% glass-filled nylon with tubular steel wall-saver legs to prevent the chair back from damaging walls. Seat flips up for easy nesting. To nest chairs together, flip seat up and nest front legs of chair between rear legs of another chair. Contoured backrest flexes to provide added comfort and movement. Seat/back options include a polymer seat and a 3D knit seat with polymer back. 3D knit seat is made with 50% post-consumer recycled polyester. The back/frame finish and seat finish can be specified as monochromatic or different colors. Chair is available with casters or glides. Ships fully assembled.

### Notes

Optional 3D knit seat is permanently affixed to chair.  
 3D knit seat does not accept Customer's Own Material (COM)/  
 Customer's Own Leather (COL).  
 It is recommended to nest a maximum of 6 chairs together when  
 transporting.  
 For information on casters and glides, see Casters and Glides in  
 appendices.

## Dimensions

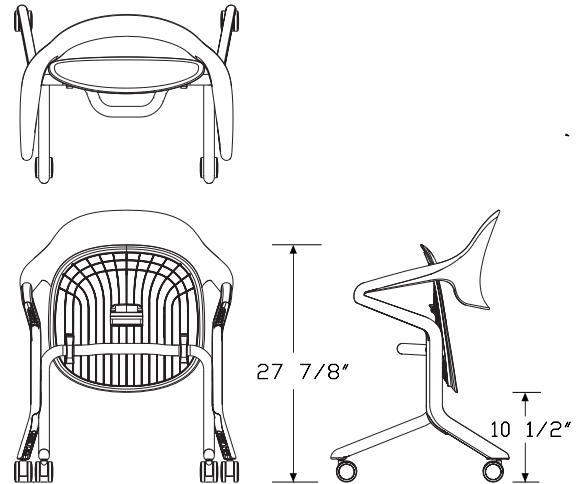
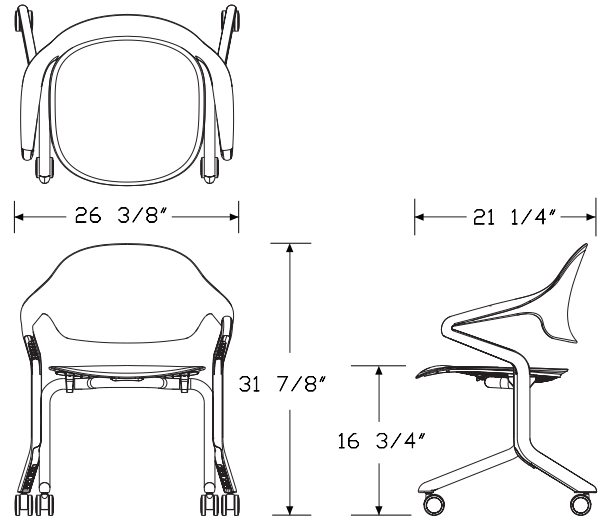



# Fuld Nesting Chair *continued*

Specification Information		
Step 1.		
<b>NEC</b>		
Step 2. Seat/Back Material		
<b>1</b>	polymer seat and back	+\$596
<b>2</b>	3D knit seat, polymer back	+\$690
Step 3. Arm Options		
<b>P</b>	arms	+\$0
Step 4. Back/Frame Finish		
<b>BK</b>	black	+\$0
<b>CC1</b>	cocoa	+\$0
<b>CRB</b>	carbon	+\$0
<b>DN2</b>	nightfall	+\$0
<b>DR1</b>	canyon	+\$0
<b>OLF</b>	olive	+\$0
<b>ZM</b>	alpine	+\$0
Step 5. Seat Finish		
<b>BK</b>	black	+\$0
<b>CC1</b>	cocoa	+\$0
<b>CRB</b>	carbon	+\$0
<b>DN2</b>	nightfall	+\$0
<b>DR1</b>	canyon	+\$0
<b>OLF</b>	olive	+\$0
<b>ZM</b>	alpine	+\$0
Step 6. 3D Knit Seat		
<i>For 3D knit seat, polymer back (2)</i>		
Price Category 1		+\$0
Step 7. Casters and Glides		
<b>BB</b>	2½" hard caster, black yoke, carpet only	+\$0
<b>GLN</b>	acetal glide, carpet only <input type="checkbox"/> A	+\$0
<b>C7</b>	2½" caster, black yoke, hard floors or carpet	+\$50
<b>OC</b>	2½" caster, medium roll resistance with quiet roll technology, black yoke, hard floors or carpet	+\$50
<b>SC8</b>	2½" caster, black yoke, hard floors or carpet with quiet roll technology	+\$50

# 20-Day or Less/Assigned Lead-Time Order Information

## 20-Day or Less and Assigned Lead-Time Programs

20-day or less and assigned lead-time products are designed for established Herman Miller dealers with pre-approved credit.

Products are distributed from multiple manufacturing facilities across the United States. All products and options not designated by an Assigned Lead-Time icon  will ship in 20 business days or less after being acknowledged by Herman Miller. Products and options designated by an  are on the assigned lead-time program and will ship in 20 days, less than 20 days, or more than 20 days from order acknowledgement.

## Ordering Procedure

Please place orders through Order Manager. If this is not available to you, place orders through mail or fax. Verbal purchase orders will not be accepted.

Order Entry fax number for Meridian®

Filing and Storage: (616) 846 9236.

Order Entry fax number for all other products:

(616) 654 3085.

For more information, contact your Customer Care representative at:  
(866) 854 3048 ext 3400.

## Shipments and Delivery

Per Herman Miller Terms and Conditions.

## Changes and Cancellation

Per Herman Miller Terms and Conditions.





# Casters and Glides

▲	<b>WARNING</b>	▲
Depending on the floor surface, chair may unexpectedly roll away from user when entering or exiting the chair, possibly leading to unexpected injury. Please refer to descriptions of floor types when selecting casters.		

**32 Caster**

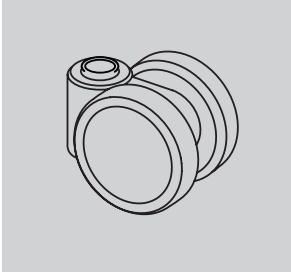

1<sup>7</sup>/<sub>8</sub>-inch-diameter hard double-wheel caster; black nylon wheels and yoke; for use on carpet only

Applicable on:  
Sayl® Chairs

**BB Caster**

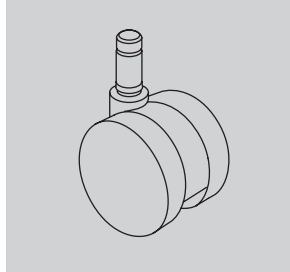

2<sup>1</sup>/<sub>2</sub>-inch-diameter hard double-wheel caster; black nylon wheels and yoke; for use on carpet only

Applicable on:  
Asari Chair by Herman Miller™  
New Aeron® Chairs  
Caper® Chairs  
Embody® Chairs  
Fuld Nesting Chairs  
Lino™ Chairs  
Sayl Chairs  
Mirra® 2 Chairs, Verus™ Chairs

**BSC Caster**

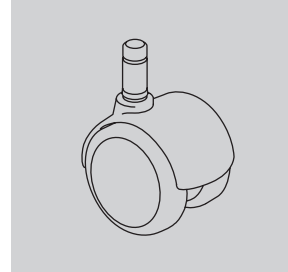

2-inch-diameter double-wheel caster; black nylon wheels and hood; soft polyurethane tread; for use on hard floors or carpet

Applicable on:  
Eames® Aluminum Group  
Eames Executive Chairs  
Eames Soft Pad Group  
Eames Task Chairs

**C9 Caster**

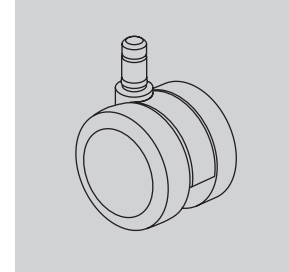

2<sup>1</sup>/<sub>2</sub>-inch-diameter double-wheel caster; black nylon wheels and yoke; soft polyurethane tread; internal brake; for use on hard floors or carpet

Applicable on:  
Caper Chairs  
Embody Chairs  
Lino Chairs  
Mirra 2 Chairs  
Sayl Chairs  
Setu® Chairs  
Verus Chairs

**49 Caster**

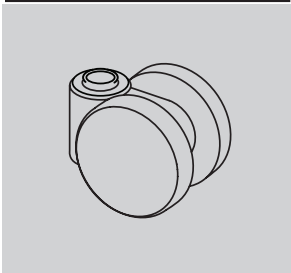

1<sup>7</sup>/<sub>8</sub>-inch-diameter soft double-wheel caster; black nylon wheels and yoke; for use on hard floors or carpet

Applicable on:  
Sayl Chairs

**BKS Caster**

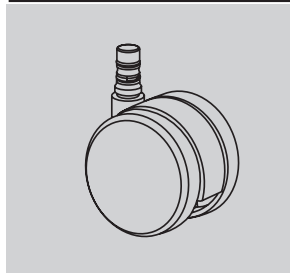

2<sup>1</sup>/<sub>2</sub>-inch-diameter hard double-wheel caster; black yoke; quiet roll technology; for use on carpet only

Applicable on:  
Cosm™ Chairs

**C7 Caster**

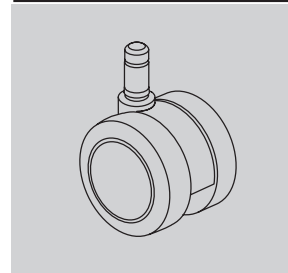

2<sup>1</sup>/<sub>2</sub>-inch-diameter double-wheel caster; black nylon wheels and yoke; soft polyurethane tread; for use on hard floors or carpet

Applicable on:  
Asari Chair by Herman Miller™  
New Aeron Chairs  
Caper Chairs  
Embody Chairs  
Fuld Nesting Chairs  
Lino Chairs                      Sayl Chairs  
Mirra 2 Chairs                  Verus Chairs

**CSQ Caster**

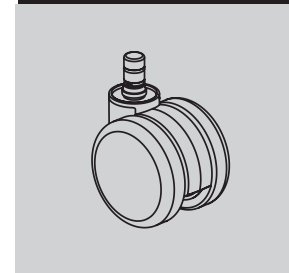

2<sup>1</sup>/<sub>2</sub>-inch-diameter double-wheel caster; color-matched nylon wheels and yoke; soft polyurethane tread; for use on hard floors or carpet

Applicable on:  
Zeph® Chairs

# Casters and Glides

continued

**DC1 Caster**

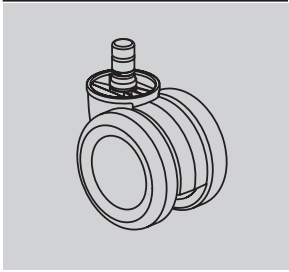

2<sup>1</sup>/<sub>2</sub>-inch-diameter double-wheel braking caster; black nylon wheels and yoke; for use on hard floors or carpet; quiet roll technology

Applicable on:

New Aeron Chairs

**H9 Caster**

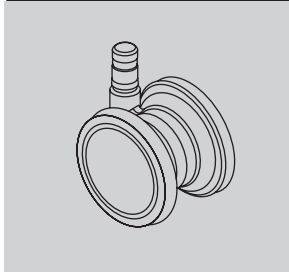

2<sup>1</sup>/<sub>2</sub>-inch-diameter double-wheel caster; clear polycarbonate wheels; nylon yoke; soft polyurethane tread; for use on carpet only

Applicable on:

Embody Chairs

**MD Caster**

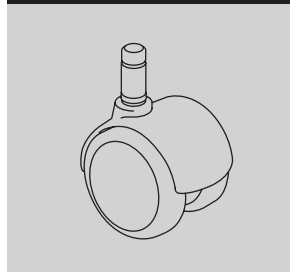

2-inch-diameter double-wheel caster; black nylon wheels with integral chrome hood; soft polyurethane tread; for use on hard floors or carpet

Applicable on:

Eames® Aluminum Group  
Eames Executive Chairs  
Eames Soft Pad Group  
Eames Task Chairs

**OC Caster**

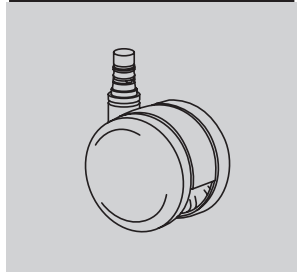

2<sup>1</sup>/<sub>2</sub>-inch-diameter double-wheel medium roll-resistant caster; black nylon wheels and yoke; soft polyurethane tread; for use on hard floors or carpet; quiet roll technology

Applicable on:

Cosm Chairs  
Fuld Nesting Chairs  
Setu Chairs

**DS Caster**

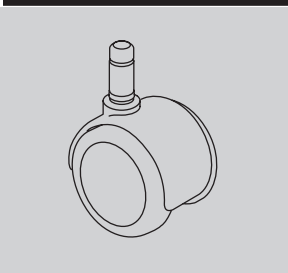

2-inch-diameter soft double-wheel braking caster; black nylon wheels and hood; for use on hard floors only

Applicable on:

Aside® Chairs  
Caper Chairs

**HCC Caster**



2<sup>1</sup>/<sub>2</sub>-inch-diameter double-wheel low roll resistance caster; black yoke; for use on hard floors or carpet

Applicable on:

Setu Chairs

**O2 Caster**



2<sup>1</sup>/<sub>2</sub>-inch-diameter double-wheel caster; nylon wheels and yoke; soft polyurethane tread; quiet roll technology; for use on hard floors or carpet

Applicable on:

Cosm Chairs

**SC8 Caster**



2<sup>1</sup>/<sub>2</sub>-inch-diameter double-wheel caster; black nylon wheels and yoke; soft polyurethane tread; quiet roll technology; for use on hard floors or carpet

Applicable on:

Cosm Chairs  
Fuld Nesting Chairs  
Lino Chairs  
Mirra 2 Chairs  
Verus Chairs

# Casters and Glides

continued

**U4 Caster**

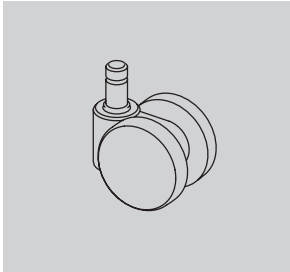

1<sup>7</sup>/<sub>8</sub>-inch-diameter hard double-wheel caster; black nylon wheels and yoke; for use on carpet only

Applicable on:

Aside Chairs  
Verus Chairs

**UD Caster**

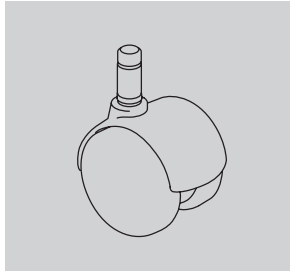

2-inch-diameter hard double-wheel caster; black nylon wheels with painted hood; for use on carpet only

Applicable on:

Eames® Aluminum Group  
Eames Executive Chairs  
Eames Soft Pad Group  
Eames Task Chairs

**16 Glide**

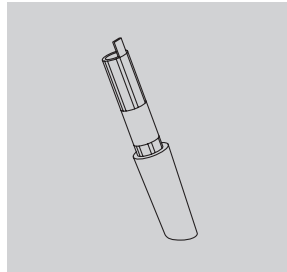

(Front glide shown)

2<sup>1</sup>/<sub>8</sub>-inch-high glide; black or fog acetal; for use on carpet only

Applicable on:

Sayl Chairs

**G4 Glide**

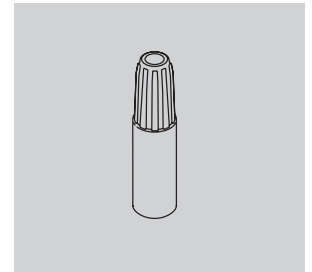

1<sup>7</sup>/<sub>8</sub>-inch-high glide; black acetal; for use on carpet only

Applicable on:

Verus Chairs

**U5 Caster**

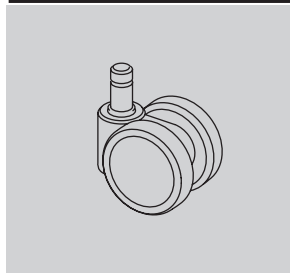

1<sup>7</sup>/<sub>8</sub>-inch-diameter soft double-wheel caster; black nylon wheels and yoke; for use on hard floors or carpet

Applicable on:

Aside Chairs  
Caper Chairs  
Verus Chairs

**VD Caster**

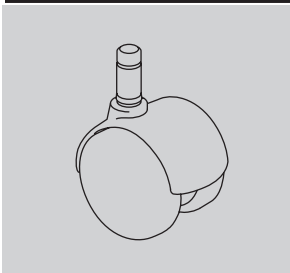

2-inch-diameter hard double-wheel caster; black nylon wheels with integral chrome hood; for use on carpet only

Applicable on:

Eames Aluminum Group  
Eames Executive Chairs  
Eames Soft Pad Group  
Eames Task Chairs

**69 Glide**

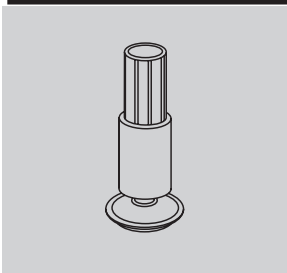

(Front glide shown)

2<sup>1</sup>/<sub>8</sub>-inch-high glide; black glass-filled nylon stem; steel-plated swivel foot with Floor Saver Glide™ insert; for use on hard floors only

Applicable on:

Sayl Chairs

**GD Glide**

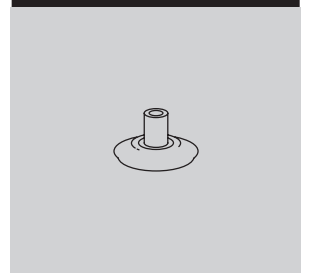

1<sup>1</sup>/<sub>2</sub>-inch-diameter glide; 1/2 inch in height; black nylon; for use on hard floors or carpet

Applicable on:

Eames Aluminum Group  
Eames Executive Chairs  
Eames Soft Pad Group  
Eames Task Chairs

# Casters and Glides

continued

## GF Glide

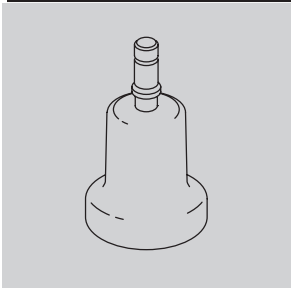

2 1/2-inch-high glide; black nylon; for use on hard floors or carpet

Applicable on:

- New Aeron Chairs
- Caper Chairs
- Cosm Chairs
- Lino Chairs
- Mirra 2 Chairs
- Sayl Chairs
- Verus Chairs

## GG Glide

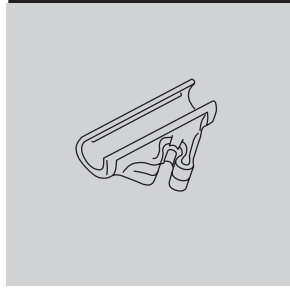

1/2-inch-high ganging glide; clear polycarbonate; for use on hard floors or carpet

Applicable on:

- Pronta Stacking Chairs

## GLN Glide

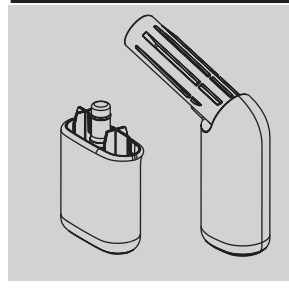

Acetal glide; for use on carpet only

Applicable on:

- Fuld Nesting Chairs

## HG Glide

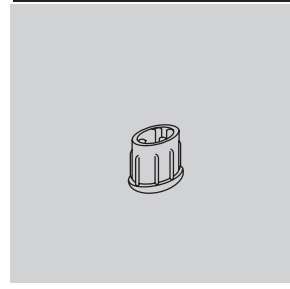

1/2-inch-high glide; black nylon glide with stainless-steel insert; for use on hard floors or carpet

Applicable on:

- Aside Chairs

## GFG Glide

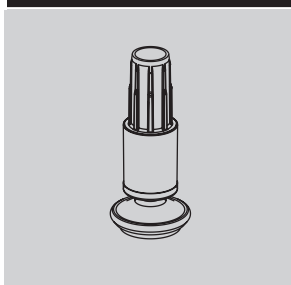

Floor Saver Glide™ insert; for use on hard floors only

Applicable on:

- Zeph Chairs

## GL Glide

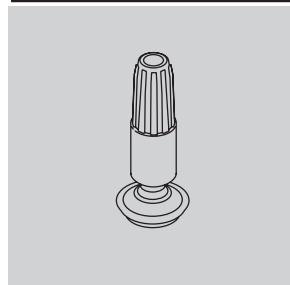

1 7/8-inch-high glide; black nylon stem; steel-plated swivel foot with Floor Saver Glide™ insert; for use on hard floors only

Applicable on:

- Verus chairs

## GNB Glide

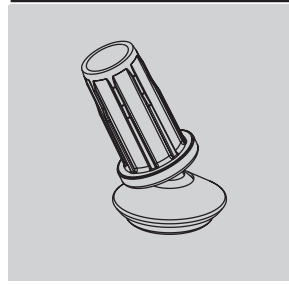

Swivel glide; nylon base; for use on carpet only

Applicable on:

- Zeph Chairs

## SG Glide (for Aside)

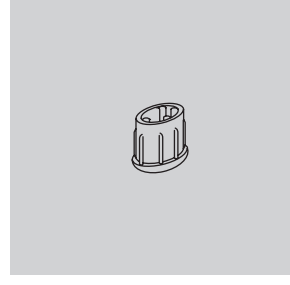

1/2-inch-high glide; black nylon; for use on carpet only

Applicable on:

- Aside Chairs

# Casters and Glides

continued



**SG Glide (for Pronta)**  
1/2-inch-high glide; clear polycarbonate; for use on hard floors or carpet  
Applicable on:  
Pronta Stacking Chairs



**XS Glide**  
1/8-inch-high glide; polycarbonate in black, fog, clear, and studio white finishes; for use on hard floors or carpet  
Applicable on:  
Sayl Chairs

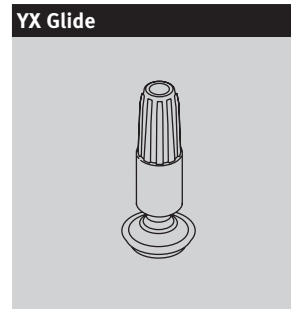

**YX Glide**  
1 7/8-inch-high glide; black nylon stem; steel-plated swivel foot with Floor Saver Glide™ insert; for use on hard floors only  
Applicable on:  
Caper Chairs

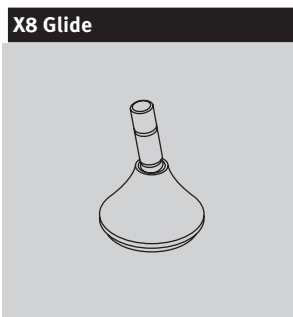

**X8 Glide**  
Glide; low profile; for use on hard floors or carpet  
Applicable on:  
Setu Chairs

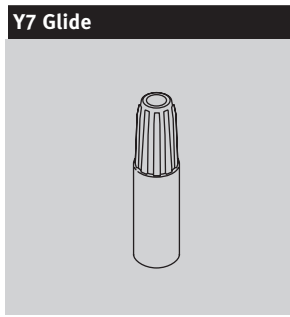

**Y7 Glide**  
1 7/8-inch-high glide; black acetal; for use on carpet only  
Applicable on:  
Caper Chairs



# Textiles Application Chart — Seating

• Available

[A] Assigned lead-time textile.

[A] Maharam textiles are on assigned lead times.

[N] Non-woven textile.

See below for exception notes.

## Price Category 1

	Aeron® Chairs	Asari Work Chairs by Herman Miller™	Cosm™ Chairs	Mirra® 2 Chairs/Stools	Embody® Chairs	Fluid Nesting Chairs	Sayl® Work Chairs/Stools	Sayl Side Chairs	Setu® Chairs/Stools	Zeph® Chairs	Verus™ Work Chairs/Stools Back	Verus Work Chairs/Stools Seat	Verus Side Chairs Back	Verus Side Chairs Seat	Verus Plus Chairs	Aside® Chairs	Caper® Chairs/Stools	Lino™ Chairs Back	Lino Chairs Seat	OE1 Storage Trolley Cushion Top	Public Office Landscape® Seat	Plex® Lounge Furniture	Swoop™ Lounge Seating - Fully Upholstered	Swoop Lounge Seating - Plywood	Valor™ Seating	Eames® Tandem Sling Seating	Cushion Tops	Workspaces	
COM Customer's Own Material [A]							1	1			1	1	1	1	1	1				1	1		1	1	1	1	1	1	1
231__ 8Z Pellicle®	•																												
1A7__ AireWeave™ 2				•																									
8T__ Crossing									•							•				•			•	•			•	•	
3DE__ Dex							•	•	•		•	•	•	•	•	•				•		19	•		•		•	•	
4RM__ Duo																		•											
6V__ Flexnet™																	•												
845__ Intercept			•																										
365__ Interweave 2											•		•																
4W__ Lyris 2™									•																				
1MN__ Monologue							24	22	•			•	•	•					•	•		•	•	•	•	•	•	•	
5H2__ Ripple 3D Knit										•																			
5H1__ Splash 3D Knit										•																			
4SC__ Scatter							•	•	•		•	•	•	•	•	•			•	•		•	•	•	•	•	•	•	
3DN__ Scribe							25	22	•		•		•	•	•	•			•	•					•		•	•	
3DK__ Stretch Knit [A]							25																						
235__ Tailored							•	•	•		•	•	•	•	•	•			•			23		•		7	•		
9NK__ Tuck 3D Knit					•																								
1WS__ Whisper							24	•	•		•	•	•	•	•	•			•	•		•	•	•	•	•	•	•	

## Price Category 2

3AR__ Aristo							•	•	•		•	•	•	•	•	•			•	•		•	•	9		•	•	
92__ Crepe							•	•	•		•	•	•	•	•	•			•	•		•	•	•	•	•	•	•
3EP__ Epic							•	•			•	•	•	•	•	•			•			•		•		7	•	
3DP__ Hint							•	•			•	•	•	•	•	•			•					•	•	•	•	•
1MV__ Marvel [N]							25	22	•										•						•	•	•	•
1HA__ Medley				•			•	22			•	•	•	•	•	•			•	•		•	•		•	•	•	•
4ME__ Mellow							•	22	•		•	•	•	•	•	•			•	•		•	•	•	•	•	•	•
ZMA__ Metaphor - Maharam [A]							16	16	•		•		•	•	•	•			•	•		•	•	•	•	•	•	•
8I1__ Muse - Maharam [A]							16	16			•		•						•						26		•	•
30__ Rhythm					23		•	•			•	•	•	•	•	•			•	•		•	•	•	•		•	•
3SL__ Sequel [N]							•	•	•		•	•	•	•	•	8			•	•		•	•	•	•	23	•	•
4TE__ Terra							•	22			•	•	•	•	•	•			•				•	•	•	7	•	•
8R__ Twist							•	•	•		•	•	•	•	•	•			•	•		•	•	•	•	•	•	•

## Price Category 3

3AC__ Ace							25	•			•	•	•	•	•	8			•	•		19		•		•	•	
43Z__ Fractal							•	•	•		•	•	•	•	•	•			•			•	•	•	•	•	•	•
8M__ Latitude™					23																							
ZM2__ Meld - Maharam * [A]		•					•	•	•		•	•	•	•	•	8			•	•	•	•	•			•	•	
4GE__ Parcel							•	•	•		•	•	•	•	•				•			•	•	•	•	•	•	•

## Price Category 4

3DM__ Daydream							25	•	•		•		•	•	•			•	•		•	•	•		•	•	•	•
ZLR__ Lariat - Maharam [N] [A]							•	•	•		•	•	•	•	•			•	•		•	•	20		•	•	•	•
3SY__ Sync				•			•	•	•		•	•	•	•	•			•			•	•	•	•	•	•	•	•

continued on next page

# Textiles Application Chart — Seating continued

• Available

[A] Assigned lead-time textile.

[A] Maharam textiles are on assigned lead times.

[N] Non-woven textile.

See below for exception notes.

	Aeron® Chairs	Asari Work Chairs by Herman Miller™	Cosm™ Chairs	Mirra® 2 Chairs/Stools	Embody® Chairs	Fuld Nesting Chairs	Say® Work Chairs/Stools	Say Side Chairs	Setu® Chairs/Stools	Zeph® Chairs	Verus™ Work Chairs/Stools Back	Verus Work Chairs/Stools Seat	Verus Side Chairs Back	Verus Side Chairs Seat	Verus Plus Chairs	Aside® Chairs	Caper® Chairs/Stools	Lino™ Chairs Back	Lino Chairs Seat	OE1 Storage Trolley Cushion Top	Public Office Landscape® Seat	Plex® Lounge Furniture	Swoop™ Lounge Seating - Fully Upholstered	Swoop Lounge Seating - Plywood	Valor™ Seating	Eames® Tandem Sling Seating	Cushion Tops	Workspaces
<b>Price Category 5</b>																												
3CY__Cozy							•	•	•		•	•	•	•	•	•				•		•	•	•	•	•	•	•
14A__Hopsak							•	•	•		•	•	•	•	•	•				•	•		•	•	•	•	•	•
40G__Method - Maharam [A]						16	16	•			•	•	•	•	•	•				•	•	•	•	•	•	•	•	•
ZNC__Nico - Maharam [A]							•	•			•	•	•	•	•	•				•		•	•	•	•	•	•	•
3SU__Summit [N]							•	•	•		•	•	•	•	•				•			•	•	•	•	•	•	•
<b>Price Category 6</b>																												
35__ Balance					•																							
<b>Price Category 7</b>																												
COL Customer's Own Leather [A]		1														8				1								1
ZB3__Beck - Maharam [A]						16	16	•			•	•	•	•	•				•		•	•	•	•	•	•	•	•
<b>Price Category 8</b>																												
ZLU__Luce - Maharam [A]		•				16	16	•			•	•	•	•	•				•		•	•	•	•	•	•	•	•
<b>Price Category 9</b>																												
ZC0__Campana - Maharam [A]						16	16				•	•	•	•	•	•				•	•	•	•	•	•	•	•	•
ZGE__Gemma - Maharam [A]							•	•	•		•	•	•	•	•	•				•	•	•	•	•	•	•	•	•
ZJA__Jasper - Maharam [A]						16	16				•	•	•	•	•	•				•	•					•		7
Z1__ Leather [N]		23														8			•	•					•			•
<b>Price Category 10</b>																												
3KH__Firma - Maharam [A]						16		•			•	•	•	•	•	•				•	•	•	•	•	•	•	•	•
ZGF__Gemma Multi - Maharam [A]							•	•	•		•	•	•	•	•	•				•	•	•	•	•	•	•	•	•
ZGF__Gemma Multi Reverse - Maharam [A]							•	•	•		•	•	•	•	•	•				•	•	•	•	•	•	•	•	•
ZP4__Petra - Maharam [A]						16	16				•	•	•	•	•	•				•	•	•	•	•	•	•	•	•
<b>Price Category A</b>																												
No fabrics available at this time.																												
<b>Price Category B</b>																												
VM__ Medium - Maharam [A]							•	•			•	•	•	•	•	•				•	•					•	•	•
TI__ Messenger - Maharam * [A]							•	•	•		•	•	•	•	•	•				•	•		•	•	•	26	•	•
<b>Price Category C</b>																												
Z27__Manner - Maharam [A]							•	•			•	•	•	•	•	•				•	•		•	•	•	•	•	•
887__Merit - Maharam [A]							•	•			•	•	•	•	•	•				•	•	•	•	•	•	•	•	•
Z3__ Metric - Maharam [A]							•	•			•	•	•	•	•	•				•	•		•	•	•	•	•	•
8EY__Murmur - Maharam [A]							•	16			•	•	•	•	•	•				•	•	•	•	•	•	•	•	7
<b>Price Category D</b>																												
8I8__ Bluff - Maharam [N] [A]						16	16				•	•	•	•	•	8				•	21		•	•		•		•
ZMD__ Mode - Maharam [A]						18	•	•			•	•	•	•	•	•				•		•	•	•		•		•
<b>Price Category E</b>																												
ZAT__ Article - Maharam [N] [A]						16	16				•	•	•	•						•	•				•			7

continued on next page



# Textiles Application Chart – Seating continued

• Available

[A] Assigned lead-time textile.

[A] Maharam textiles are on assigned lead times.

[N] Non-woven textile.

See below for exception notes.

	Aeron® Chairs	Asari Work Chairs by Herman Miller™	Cosm™ Chairs	Mirra® 2 Chairs/Stools	Embody® Chairs	Fuid Nesting Chairs	Sayl® Work Chairs/Stools	Sayl Side Chairs	Setu® Chairs/Stools	Zeph® Chairs	Verus™ Work Chairs/Stools Back	Verus Work Chairs/Stools Seat	Verus Side Chairs Back	Verus Side Chairs Seat	Verus Plus Chairs	Aside® Chairs	Caper® Chairs/Stools	Lino™ Chairs Back	Lino Chairs Seat	OE1 Storage Trolley Cushion Top	Public Office Landscape® Seat	Plex® Lounge Furniture	Swoop™ Lounge Seating - Fully Upholstered	Swoop Lounge Seating - Plywood	Valor™ Seating	Eames® Tandem Sling Seating	Cushion Tops	Workspaces
<b>Price Category F</b>																												
82T__Apt - Maharam [N] [A]							18	•					•	•														7
871__Brindle - Maharam [A]							16	16				•		•					•	•	•					•		•
87Z__Conduit - Maharam [A]							16	16			•	•	•	•					•		•							7
74M__Instill - Maharam [N] [A]							18	16			•	•	•	•					•		•	•		•	•			7
89N__Keen - Maharam [A]							16	16				•		•	•				•		•	•	•	•	•			
V9G__Ledger - Maharam [N] [A]							18	16			•	•	•	•	•				•	•						•		
ZLL__Loop - Maharam [A]							16	16			•						8		•		•					•		
82A__Multiply - Maharam [A]							16	16			•	•	•	•					•		•				•	•	•	
8LW__Pepper - Maharam [A]							16	16				•		•					•		•		21	•		9		•
Z33__Strum - Maharam [N] [A]							16																•		•			7
<b>Price Category G</b>																												
ZC2__Compound - Maharam [N] [A]							16	16			•	•	•	•			8		•			•		•	•			7
ZF1__Fold - Maharam [N] [A]							16	16																		•		7
8AR__Gild - Maharam [A]								16				•	•	•	•							21	•	•	•	•		
ZPR__Pare - Maharam [A]							18	16			•		•				8		•		•	•	•	•				7
ZRF__Runner - Maharam [A]							16	16												•					•		•	
<b>Price Category H</b>																												
ZT__Circles - Maharam [A]							16	16																				•
ZK__Dot Pattern - Maharam [A]							•	•	•		•		•							•					•		•	•
ZL__Small Dot Pattern - Maharam [A]							•	•	•		•		•							•					•		•	•
<b>Price Category I</b>																												
7CW__Cursive - Maharam [A]							16	16			•	•	•	•			8		•	•	•		•		•		•	•
ZSY__Study - Maharam [A]																				•						•		
<b>Price Category J-K</b>																												
No fabrics available at this time.																												
<b>Price Category L</b>																												
ZMK__Minicheck - Maharam [A]							•	•			•	•	•					•							•			7
<b>Price Category M</b>																												
ZF2__Fruit - Maharam [A]							16										•											7
<b>Price Category N-Q</b>																												
No fabrics available at this time.																												
<b>Price Category R</b>																												
Stow Leather		•																										
<b>Price Category S-Z</b>																												
No fabrics available at this time.																												

continued on next page

# Textiles Application Chart — Seating continued

- Available

[A] Assigned lead-time textile.

[A] Maharam textiles are on assigned lead times.

[N] Non-woven textile.

See below for exception notes.

*Application Note: Herman Miller cannot guarantee material/pattern alignment in adjacent products. For example, a fabric's pattern may not align from one pedestal cushion top to the next, or from one chair to another.*

*\* Available in select colors on 20-day lead-time. Refer to "Maharam Colors - Seating" for 20-day colors.*

- |    |  |    |   |
|----|--|----|---|
| 1  | Refer to price book appendices and Omni for COM/COL information.   | 21 | Available on Plex seat and on Ottoman.                                    |
| 7  | Available on 1" Cushion Tops only.                                 | 22 | Not available on Sayl side chairs with upholstered backs.                 |
| 8  | Only available on the Aside nonupholstered outer back option (PB). | 23 | Available in select colors. Refer to "Textile Colors" for color offering. |
| 9  | Available on Valor upholstered seat only.                          | 24 | Not available on Sayl upholstered High-Back Work Chairs.                  |
| 16 | Available on Sayl Chair seat.                                      | 25 | Not available on Sayl upholstered back work chairs.                       |
| 18 | Available on Sayl Chair seat and upholstered mid-back.             | 26 | Available in select colors. Refer to "Textile Colors" for color offering. |
| 19 | Available on Plex seat only.                                       |    |   |
| 20 | Not available on Plex Club Chair with Headrest.                    |    |   |

# Textile Colors

## Price Category 1

**Customer's Own Material**  
See Order Information in Appendices. Assigned lead-time textile. [A](#)

**8Z Pellicle®**  
Seating  
For New Aeron® Chairs  
56% elastomeric  
44% polyester  
23101 Mineral  
23102 Carbon  
23103 Graphite

**AireWeave™ 2**  
Seating  
For Mirra® 2 Chairs  
67% elastomeric  
33% antimony-free polyester  
1A701 Alpine  
1A702 Slate Grey  
1A703 Graphite  
1A704 Lime Green  
1A705 Cappuccino  
1A706 Urban Orange  
1A707 Dark Turquoise  
1A708 Twilight

**Chain**  
Workspaces  
66" wide  
100% recycled polyester with 12% ocean bound plastic  
2V01 Pearl  
2V02 Oyster  
2V03 Wheat  
2V04 Linen  
2V05 Wicker  
2V06 Bamboo  
2V07 Sage  
2V08 Spring Wood  
2V09 Iceberg

**Crossing**  
Seating/Workspaces  
54" wide  
86% antimony-free polyester  
14% polyester  
8T03 Wicker \*  
8T04 Porcelain \*  
8T05 Warm Grey \*  
8T10 Tomato  
8T17 Cerulean  
8T18 Indigo  
8T19 Shale \*  
8T22 Tin \*  
8T23 Graphite  
8T24 Black

**Crossing**  
Workspaces  
For workspaces products only.  
54" wide  
86% antimony-free polyester  
14% polyester  
8501 Ivory \*  
8502 Oyster \*

\* Colors available on Exclave®  
Video-friendly Tackable Boards and Stowage Tackable Backdrop

**Dex**  
Ancillary/Seating/Workspaces  
54" wide  
67% recycled polyester  
33% polyester  
3DE01 Frost  
3DE02 Silver Pine  
3DE03 Stone  
3DE04 Shale  
3DE05 Charcoal  
3DE06 Gossamer  
3DE07 Pine

**Duo**  
Seating  
For Lino™ Chairs  
52% polyester  
48% elastomeric  
4RM01 Mineral  
4RM02 Poppy  
4RM03 Green Leaf  
4RM04 Jade  
4RM05 Shadow  
4RM06 Graphite

**Flexnet™**  
Seating  
For Caper® Chairs  
69% elastomeric  
31% polyester  
6V01 Black  
6V02 Silver Grey

**Grasscloth**  
Workspaces  
66" wide  
100% recycled polyester with 11% ocean bound plastic  
2I01 Silver Birch  
2I02 Pampas  
2I03 Sedge  
2I07 Lea  
2I08 Taro  
2I09 Steam Grey  
2I13 Gravel

**Intercept**  
Seating  
For Cosm™ Chairs  
60% elastomeric  
40% polyester  
84501 Graphite  
84502 Carbon  
84503 Mineral  
84504 Nightfall  
84505 Glacier  
84506 Canyon

**Interweave 2**  
Seating  
For Verus™ Chairs  
65% elastomeric  
35% polyester  
36501 Iceberg  
36502 Poppy  
36503 Beachglass  
36504 Blue Grotto  
36505 Slate  
36506 Shale

**Lyris 2™**  
Seating  
For Setu® Chairs  
74% elastomeric  
26% polyester  
4W21 Alpine  
4W23 Chartreuse  
4W25 Berry Blue  
4W26 Slate Grey  
4W28 Chino  
4W31 Graphite

**Monologue**  
Ancillary/Seating/Workspaces  
54" wide  
56% recycled polyester  
44% polyester  
1MN01 Linen  
1MN02 Alabaster  
1MN04 Folkstone  
1MN05 Silver Pine  
1MN06 Slate  
1MN07 Seed  
1MN09 Persimmon  
1MN11 Meadow  
1MN12 Blue Sky  
1MN13 Blue Spruce  
1MN14 Deep Sea

Price category 1 continued on next page

- Maharam textiles are on assigned lead times [A](#).
- Fabric numbers are listed as Herman Miller fabric number/Maharam fabric number.

# Textile Colors

continued

## Price Category 1

continued

Appendix: Textile Colors

Resonance	
Workspaces	
66" wide	
100% polyester	
5T04	Greige
5T05	Porcelain
5T06	Alabaster
5T15	Iris
5T28	Sugar
5T47	Tobacco
5T54	Saltbush
5T57	Seed
5T58	Sepia
5T60	Iceberg
5T65	Red
5T67	Boysenberry
5T68	Pistachio
5T69	Green Apple
5T71	Jade
5T72	Blue Green
5T74	Twilight

Ripple 3D Knit	
Seating	
Available only on Zeph® Chairs.	
knit to size	
99% recycled polyester	
1% lycra	
5H201	Black
5H202	Carbon
5H203	Alpine
5H204	Silt
5H205	Tea Rose
5H206	Cocoa
5H207	Persimmon
5H208	Blaze
5H209	Cayenne
5H210	Falcon
5H211	Mustard Seed
5H212	Patina
5H213	Olive
5H214	Moss
5H215	Aloe
5H216	Glacier
5H217	Ultramarine
5H218	Nightfall
5H219	Bluebell
5H220	Boysenberry
5H221	Nightfall/Bluebell
5H222	Patina/Alpine
5H223	Cayenne/Glacier
5H224	Tea Rose/Olive
5H225	Silt/Blaze

Scatter	
Ancillary/Seating/Workspaces	
54" wide	
100% recycled polyester, with 26% ocean bound plastic	
4SC01	Alpine
4SC02	Fog
4SC03	Shale
4SC04	Persimmon
4SC07	Olive
4SC08	Glacier
4SC09	Blue Sky
4SC10	Lagoon
4SC11	Slate Grey
4SC12	Blue Black

Scribe	
Seating/Workspaces	
54" wide	
100% recycled polyester with 53% ocean bound plastic	
3DN01	Spring Wood
3DN02	Poplar
3DN03	Pewter
3DN04	Deep Sea
3DN05	Fir
3DN06	Nutmeg

Slant	
Workspaces	
66" wide	
51% polyester	
49% recycled polyester	
22F04	Pesto
22F06	Neptune
22F07	Blueberry
22F10	Pumpkin
22F12	Silver Birch
22F13	Bluestone
22F15	Shale

Splash 3D Knit	
Seating	
Available only on Zeph® Chairs.	
knit to size	
98% recycled polyester	
2% lycra	
5H101	Black
5H102	Carbon
5H103	Alpine
5H104	Silt
5H105	Tea Rose
5H106	Cocoa
5H107	Persimmon
5H108	Blaze
5H109	Cayenne
5H110	Falcon
5H111	Mustard Seed
5H112	Patina
5H113	Olive
5H114	Moss
5H115	Aloe
5H116	Glacier
5H117	Ultramarine
5H118	Nightfall
5H119	Bluebell
5H120	Boysenberry

Stretch Knit	
Seating	
Assigned lead-time textile. <sup>A</sup>	
Available only on Say®	
Suspension Back Work Chairs	
97% polyester, 3% spandex	
3DK01	Fog
3DK02	Slate Grey
3DK03	Java
3DK04	Black
3DK05	Red
3DK06	Green Apple
3DK07	Berry Blue

Price category 1 continued on next page

- Maharam textiles are on assigned lead times <sup>A</sup>.
- Fabric numbers are listed as Herman Miller fabric number/Maharam fabric number.

# Textile Colors

continued

## Price Category 1

continued

Tailored	
Ancillary/Seating/Workspaces 54" wide 56% polyester 44% recycled polyester	
23501	Studio White * **
23502	Sugar *
23503	Tomato
23506	Chive
23508	Cobalt
23509	Cadet
23510	Fog
23511	Graphite
23512	Black
23513	Coffee

\* Colors not available on Plex™ Lounge Furniture.  
\*\* Color not available on Canvas Tiles.

Tuck 3D Knit	
Seating Available only on Fuld Nesting Chairs. knit to size 56% polyester 44% recycled polyester	
9NK01	Alpine
9NK02	Carbon
9NK03	Nightfall
9NK04	Olive
9NK05	Cocoa
9NK06	Canyon

Whisper	
Ancillary/Seating/Workspaces 54" wide 73% recycled polyester 27% polyester with 11.3% ocean bound plastic	
1WS01	Sand Dollar
1WS02	Pebble
1WS03	Silver Birch
1WS04	Iceberg
1WS05	Silver Pine
1WS06	Carbon
1WS07	Cumin
1WS12	Willow
1WS13	Sea Grass
1WS14	Pool
1WS15	Blueberry
1WS16	Glacier
1WS17	Grey
1WS18	Canyon

## Price Category 2

Aristo	
Ancillary/Seating/Workspaces 54" wide 88% recycled polyester 12% polyester Acrylic backing	
3AR01	Forest Moss
3AR02	Light Brindle
3AR03	Mink
3AR04	Copper
3AR05	Adobe
3AR06	Cherry
3AR07	Lilac
3AR08	Green Apple
3AR09	Surf
3AR10	Waterfall
3AR11	Cadet
3AR12	Tin
3AR13	Pewter
3AR14	Grey Brindle
3AR15	Grey Black

Cord	
Workspaces 66" wide 51% antimony-free polyester 49% polyester	
5101	Ivory
5102	White Ash
5103	Linen
5104	Bamboo
5105	Sepia
5107	Sesame
5109	Bayou
5111	Spring Wood
5112	Summer White

Crepe	
Ancillary/Seating/Workspaces 54" wide 100% recycled polyester, with 43.6% ocean bound plastic	
9201	Licorice
9203	Smoke
9207	Cherry
9223	Cadet
9241	Beachglass
9249	Stone *
9251	Fog *
9252	Slate Grey
9261	Shale
9262	Graphite
9265	Mineral
9266	Persimmon
9267	Juniper
9268	Glacier
9269	Cascade
9270	Navy

\* Colors available on Exclave® Video-friendly Tackable Boards and Stowage Tackable Backdrop.

Price category 2 continued on next page

- Maharam textiles are on assigned lead times <sup>A</sup>.
- Fabric numbers are listed as Herman Miller fabric number/Maharam fabric number.

# Textile Colors

continued

## Price Category 2

continued

Appendix: Textile Colors

Epic	
Ancillary/Seating/Workspaces	
54" wide	
56% recycled polyester	
44% polyester	
Acrylic backing	
3EP01	Alabaster
3EP02	Smoke
3EP03	Falcon
3EP05	Copper
3EP06	Urban Orange
3EP07	Poppy
3EP10	Clover
3EP11	Loden
3EP14	Peacock
3EP15	Cadet
3EP16	Indigo
3EP17	Spring Wood
3EP18	Grey Brindle
3EP19	Seed
3EP20	Carbon Dark
Hint	
Ancillary/Seating/Workspaces	
54" wide	
76% recycled polyester	
24% polyester	
3DP01	Sediment
3DP02	Gunmetal
3DP03	Silt
3DP04	Porcelain
3DP05	Indigo
3DP06	Fern
3DP07	Adobe
3DP08	Red Sea

Horizon	
Workspaces	
54" wide	
65% antimony-free polyester	
35% polyester	
4N01	Rye Grass
4N02	Sugar Pine
4N03	Silver Pine
4N04	White Ash
4N05	Spring Wood
4N08	Haystack
4N09	Oat Grass
4N13	Pine Cone
4N15	Elderberry

Marvel	
Ancillary/Seating	
54" wide	
100% pvc-free polyurethane	
antimicrobial, antibacterial finish	
1MV01	Summer White
1MV02	Sand Dollar
1MV03	Espresso
1MV04	Folkstone Grey
1MV05	Graphite
1MV06	Onyx
1MV07	Polar Blue
1MV08	Blush Grey
1MV12	Red
1MV14	Pine
1MV15	Teal Green
1MV16	Twilight

Medley	
Ancillary/Seating/Workspaces	
54" wide	
100% polyester	
1HA01	Stone *
1HA02	Trail
1HA03	Charcoal
1HA04	Cinder
1HA07	Chutney
1HA09	Feather Grey *
1HA11	Loden
1HA13	Bayou *
1HA14	Blue Grotto
1HA15	Blueberry
1HA22	Khaki
1HA23	Pewter
1HA24	Yellow Oxide
1HA25	Vintage Rose
1HA26	Raspberry
1HA27	Acai Berry

\* Colors available on Exclave®  
Video-friendly Tackable Boards  
and Stowage Tackable Backdrop

Mellow	
Ancillary/Seating/Workspaces	
54" wide	
100% recycled polyester, with 16% ocean bound plastic	
4ME01	Mineral
4ME04	Olive
4ME05	Glacier
4ME06	Oceanside
4ME07	Charcoal

Metaphor – Maharam	
Ancillary/Seating/Workspaces	
54" wide	
100% polyester	
Acrylic backing	
ZMA01/466553-001	Afterfeather *
ZMA02/466553-002	Moonflower
ZMA03/466553-003	Handcraft
ZMA04/466553-004	Crossroad
ZMA05/466553-005	Chondrite
ZMA06/466553-006	Detective
ZMA07/466553-007	Steamship
ZMA08/466553-008	Electricity
ZMA09/466553-009	Takeoff
ZMA10/466553-010	Parachute
ZMA11/466553-011	Blueshift
ZMA12/466553-012	Dockyard
ZMA13/466553-013	Bathe
ZMA14/466553-014	Icebound
ZMA15/466553-015	Thermosphere
ZMA16/466553-016	Aboard
ZMA17/466553-017	Agaware
ZMA18/466553-018	Homeland
ZMA19/466553-019	Rockfall
ZMA20/466553-020	Undergrowth
ZMA21/466553-021	Gremolata
ZMA22/466553-022	Patina
ZMA23/466553-023	Sylvan
ZMA24/466553-024	Outfield
ZMA25/466553-025	Windbreak
ZMA26/466553-026	Saguaro

Price category 2 continued on  
next page

- Maharam textiles are on assigned lead times [A](#).
- Fabric numbers are listed as Herman Miller fabric number/Maharam fabric number.

# Textile Colors

continued

## Price Category 2

continued

### Metaphor continued

ZMA27/466553-027	Barnwood
ZMA28/466553-028	Cookshop
ZMA29/466553-029	Amandine
ZMA30/466553-030	Bodhran
ZMA31/466553-031	Centerstage
ZMA32/466553-032	Focaccia
ZMA33/466553-033	Bumblebee
ZMA34/466553-034	Microbrew
ZMA35/466553-035	Sauna
ZMA36/466553-036	Gazebo
ZMA37/466553-037	Pirouette
ZMA38/466553-038	Heartbeat
ZMA39/466553-039	Shino
ZMA40/466553-040	Sunrise
ZMA41/466553-041	Florist
ZMA42/466553-042	Beadwork
ZMA43/466553-043	Framboise
ZMA44/466553-044	Wisteria
ZMA45/466553-045	Warrior

\* Colors not available on Eames Aluminum Group, Soft Pad, Sofa Compact, Molded Fiberglass/Plastic Chairs, Task Chair, Wire Chairs, Nelson Platform Bench Cushion, Swoop Plywood Lounge Chair.

### Muse – Maharam

Ancillary/Seating/Workspaces	
54" wide	
100% post-consumer recycled polyester	
8I101/466487-001	Crescendo
8I102/466487-002	Resonate
8I103/466487-003	Runway
8I104/466487-004	Ascend
8I105/466487-005	Veil *
8I106/466487-006	Refresh *
8I107/466487-007	Clear *
8I108/466487-008	Fantasy
8I109/466487-009	Miso
8I110/466487-010	Compass
8I111/466487-011	Bergamot *
8I112/466487-012	Grasshopper

### Muse continued

8I113/466487-013	Goal
8I114/466487-014	Mistletoe
8I115/466487-015	Seaglass *
8I116/466487-016	Frigid
8I117/466487-017	Riverbend
8I118/466487-018	Noble
8I119/466487-019	Pulsar
8I120/466487-020	Velella
8I121/466487-021	Sailboat
8I122/466487-022	Sparse
8I123/466487-023	Vase
8I124/466487-024	Haven
8I125/466487-025	Mead
8I126/466487-026	Neat
8I127/466487-027	Jovial
8I128/466487-028	Theater
8I129/466487-029	Poinsettia
8I130/466487-030	Celebrate
8I131/466487-031	Spectacle

\* Colors not available on Valor Seating.

### Rhythm

Ancillary/Seating	
54" wide	
100% polyester	
3002	Green Apple
3004	Bayou
3005	Berry Blue
3006	Iris
3007	Twilight
3009	Poppy
3010	Molasses
3012	Khaki
3013	Mink
3014	Black *
3015	Charcoal *

\* Colors available on Embody® Chair.

### Sequel

Ancillary/Seating/Workspaces	
54" wide	
100% vinyl	
100% polyester knit backing	
Resilience® finish	
3SL01	White
3SL02	Pebble
3SL03	Mushroom
3SL04	Stone
3SL06	Rattan
3SL09	Seal
3SL10	Blue Fog
3SL11	Folkstone
3SL12	Shale
3SL13	Slate Grey
3SL14	Charcoal
3SL15	Carbon Dark
3SL28	Navy *

\* Color available on Eames® Tandem Sling Seating.

### Terra

Ancillary/Seating/Workspaces	
54" wide	
100% post-consumer recycled biodegradable polyester *	
4TE01	Spring Wood
4TE02	Zinc
4TE03	Pine Cone
4TE04	Charcoal

\* 1% biodegradation in 1,278 days under ASTM D5511 conditions. No evidence of further degradation.

### Twine

Workspaces	
66" wide	
100% recycled polyester	
3TW01	Silver Birch
3TW02	Ivory
3TW03	Alabaster
3TW04	Bamboo
3TW05	Iceberg
3TW06	Charcoal
3TW07	Feather Grey
3TW08	Shale

### Twist

Ancillary/Seating/Workspaces	
54" wide	
80% antimony-free polyester	
13% recycled polyester	
7% polyester	
8R05	Wicker
8R10	Poppy
8R14	Tin
8R15	Shale
8R16	Graphite
8R17	Birch
8R18	Sepia
8R22	Blueberry
8R23	Green Apple
8R26	Gunmetal
8R27	Cinder
8R29	Pekoe
8R33	Forest
8R35	Waterfall
8R36	Midnight Blue
8R37	Carbon Dark

### Twist

Workspaces	
For workspaces products only.	
54" wide	
80% antimony-free polyester	
13% recycled polyester	
7% polyester	
5S03	Oyster

- Maharam textiles are on assigned lead times [A](#).
- Fabric numbers are listed as Herman Miller fabric number/Maharam fabric number.

# Textile Colors

continued

## Price Category 3

Appendix: Textile Colors

Ace	
Ancillary/Seating	
54" wide	
100% polyurethane	
Polyester knit backing	
Stain resistant finish	
3AC01	Summer White
3AC02	White Ash
3AC03	Rye
3AC04	Metal
3AC05	Clay
3AC06	Chestnut
3AC08	Camelback
3AC09	Chipotle
3AC12	Artichoke
3AC13	Sepia Dark
3AC14	Aloe
3AC15	Flint
3AC16	Blue Sky
3AC17	Oceanside
3AC18	Midnight
3AC20	Frost
3AC21	Lead
3AC22	Black

Fractal	
Ancillary/Seating/Workspaces	
58" wide	
84% recycled polyester	
16% polyester	
43Z01	Granite
43Z02	Golden Olive
43Z03	Verdant
43Z04	Cadet

Ground Cloth®	
Workspaces	
66" wide	
100% polyester	
4701	Vapor Grey
4721	Warm White *
4722	Fog *
4723	Straw *
4724	Red Orange *
4726	Green Apple *
4727	Caribbean *
4728	Midnight *
4729	Cappuccino *

\* Colors available on Exclave®  
Video-friendly Tackable Boards  
and Stowage Tackable Backdrop

Latitude	
Seating	
Colors for Mirra 2 Chairs	
100% polyester	
8M10	Alpine
8M17	Black
8M21	Slate Grey
8M23	French Press
8M25	Dark Turquoise
8M26	Twilight

Meld – Maharam	
Ancillary/Seating/Workspaces	
54" wide	
68% post-consumer recycled polyester	
32% polyester	
PFOA-Free stain resistant	
ZM201/466387-201	Vast
ZM202/466387-202	Panda **
ZM203/466387-203	Skyline *
ZM204/466387-204	Knight **
ZM205/466387-205	Quill **
ZM206/466387-206	Pipe
ZM207/466387-207	Grate *
ZM208/466387-208	Gloss

Meld continued	
ZM209/466387-209	Bulb
ZM210/466387-210	Bride
ZM211/466387-211	Stark
ZM212/466387-212	Seashell
ZM213/466387-213	Antler
ZM214/466387-214	Crater *
ZM215/466387-215	Perennial
ZM216/466387-216	Mulberry
ZM217/466387-217	Fuchsia *
ZM218/466387-218	Amethyst *
ZM219/466387-219	Merlot
ZM220/466387-220	Magma *
ZM221/466387-221	Rooster
ZM222/466387-222	Heat *
ZM223/466387-223	Clementine
ZM224/466387-224	Fox
ZM225/466387-225	Kiss *
ZM226/466387-226	Bare
ZM227/466387-227	Blonde
ZM228/466387-228	Mimosa
ZM229/466387-229	Comet *
ZM230/466387-230	Honeydew
ZM231/466387-231	Wild *
ZM232/466387-232	Vine
ZM233/466387-233	Seed
ZM234/466387-234	Kale *
ZM235/466387-235	Waterfall *
ZM236/466387-236	Nordic *
ZM237/466387-237	Reef *
ZM238/466387-238	Wave
ZM239/466387-239	Isle **
ZM240/466387-240	Creek
ZM241/466387-241	Mariner *
ZM242/466387-242	Globe
ZM243/466387-243	Spa

\* Colors available on 20-day lead time.  
\*\* Colors available on 10-day lead time.

Parcel	
Ancillary/Seating/Workspaces	
54" wide	
100% recycled polyester	
4GE01	Gunmetal
4GE02	Brindle
4GE03	Bayou
4GE04	Pesto
4GE05	Golden Olive
4GE06	Copper Sea

Saille - Geiger Textile	
Ancillary	
57" wide	
69% cotton	
31% polyester	
PFOA-Free stain resistant finish	
Acrylic backing	
18001	Coal
18002	Shale
18003	Haze
18004	Stone
18005	White *
18006	Beach
18007	Sand
18008	Blush
18009	Brick
18010	Fog
18011	Celadon
18012	Poolside
18013	Summer Sky
18014	Lake
18015	Midnight Blue

\* Color not available on Eames® Soft Pad Group Chairs/Ottomans.

Price category 3 continued on next page

- Maharam textiles are on assigned lead times [A](#).
- Fabric numbers are listed as Herman Miller fabric number/Maharam fabric number.



# Textile Colors

continued

## Price Category 3

continued

Strands	
Workspaces	
66" wide	
100% recycled polyester	
8W01	Pebble
8W02	Porcelain
8W03	Taupe
8W04	Honey
8W05	Khaki
8W06	Rye
8W07	Wicker
8W08	Tin
8W09	Cool Grey

## Price Category 4

Cygnus	
Ancillary	
For Eames® Aluminum Group Chairs	
69% elastomeric	
31% polyester	
5401	Black
5402	Zinc
5403	Quartz

Daydream	
Ancillary/Seating/Workspaces	
54" wide	
48% wool	
41% recycled polyester	
9% nylon	
2% polyester	
3DM01	Rye Grass
3DM02	Silver Birch
3DM03	Pewter
3DM04	Graphite
3DM05	Black
3DM06	Lemongrass
3DM07	Permission
3DM08	Juniper
3DM09	Sea Grass
3DM10	Nightfall

Hush	
Workspaces	
66" wide	
80% polyester	
20% viscose	
1HS01	Canyon
1HS02	Pesto
1HS03	Bayou
1HS04	Greystone
1HS05	Charcoal
1HS06	Rye Grass
1HS07	Cool Grey
1HS08	Dark Grey
1HS09	Aqua Green
1HS10	Nightfall

Kalista - Geiger Textile	
Ancillary	
54" wide	
71% post-industrial recycled cotton	
18% post-industrial recycled polyester	
11% polyester	
PFOA-Free stain resistant finish	
1AL01	Cotton
1AL02	Natural
1AL03	Titanium
1AL04	Pewter
1AL05	Starry Night
1AL06	Red Hot
1AL07	Sun Kissed
1AL08	Dune
1AL09	Beach Glass
1AL10	Bluestone
1AL11	Seaside
1AL12	Night Sky

Lariat - Maharam	
Ancillary/Seating	
54" wide	
100% vinyl	
ZLR01/440401-001	001
ZLR02/440401-002	002
ZLR04/440401-004	004
ZLR06/440401-006	006
ZLR07/440401-007	007
ZLR08/440401-008	008
ZLR10/440401-010	010
ZLR11/440401-011	011
ZLR13/440401-013	013
ZLR14/440401-014	014
ZLR15/440401-015	015
ZLR16/440401-016	016
ZLR18/440401-018	018
ZLR20/440401-020	020
ZLR21/440401-021	021
ZLR24/440401-024	024
ZLR25/440401-025	025
ZLR26/440401-026	026

Lariat continued	
ZLR28/440401-028	028
ZLR31/440401-031	031
ZLR32/440401-032	032
ZLR33/440401-033	033
ZLR34/440401-034	034
ZLR38/440401-038	038
ZLR39/440401-039	Granite
ZLR40/440401-040	Linen
ZLR41/440401-041	Stella
ZLR42/440401-042	Saddle
ZLR43/440401-043	Holly
ZLR44/440401-044	Maroon
ZLR45/440401-045	Siren
ZLR46/440401-046	Reseda
ZLR47/440401-047	Purslane
ZLR48/440401-048	Spire
ZLR49/440401-049	Papyrus
ZLR50/440401-050	Chickadee
ZLR51/440401-051	Requiem

Sync	
Ancillary/Seating	
55" wide	
100% polyester	
3SY01	Pine Cone
3SY03	Canyon
3SY04	Truffle
3SY06	Everglade
3SY08	Nightfall
3SY09	Dark Mineral
3SY10	Slate Grey
3SY11	Dark Carbon
3SY12	Black

Appendix: Textile Colors

- Maharam textiles are on assigned lead times [A](#).
- Fabric numbers are listed as Herman Miller fabric number/Maharam fabric number.

# Textile Colors

continued

## Price Category 5

Appendix: Textile Colors

Cozy	
Ancillary/Seating	
54" wide	
100% wool	
3CY01	Heathered Warm Grey
3CY02	Heathered Rye Grass
3CY03	Heathered Cool Grey
3CY05	Heathered Black
3CY06	Heathered Persimmon
3CY07	Heathered Loden
3CY09	Heathered Lagoon
3CY10	Heathered Twilight

Hopsak	
Ancillary/Seating/Workspaces	
56" wide	
100% recycled polyester	
14A20	Black
14A22	Raw Umber Dark
14A26	Grey Blue Dark
14A30	Sepia Dark
14A38	Emerald Dark
14A39	Yellow Dark
14A40	Orange
14A41	Sienna
14A42	Olive Green Dark
14A43	Crimson
14A44	Crimson Dark Dark
14A45	Violet Dark
14A46	Pink Dark Dark
14A47	Ultramarine Dark
14A48	Cobalt Blue
14A49	Terra Cotta
14A50	Ochre Dark

Ingenu - Geiger Textile	
Ancillary	
54" wide	
28% wool	
26% viscose	
25% acrylic	
16% polyester	
5% cotton	
PFOA-Free stain resistant finish	
1GH01	Sand
1GH02	Fog
1GH03	Flannel
1GH04	Trench
1GH05	Vermillion
1GH06	Adriatic
1GH07	Umber
1GH08	Charcoal

Method - Maharam	
Ancillary/Seating/Workspaces	
54" wide	
100% recycled polyester	
with 9% ocean-bound plastic	
40G01/466579-001	Inspire
40G02/466579-002	Rhea
40G03/466579-003	Noise
40G04/466579-004	Speedway
40G05/466579-005	Villanelle
40G06/466579-006	Maestro
40G07/466579-007	Destiny
40G08/466579-008	Possess
40G09/466579-009	Waterside
40G10/466579-010	Relax
40G11/466579-011	Delightful
40G12/466579-012	Parrotlet
40G13/466579-013	Verdurous
40G14/466579-014	Bosky
40G15/466579-015	Acreage
40G16/466579-016	Allude
40G17/466579-017	Tweed
40G18/466579-018	Korma
40G19/466579-019	Fossilize
40G20/466579-020	Cattail
40G21/466579-021	Shortcake
40G22/466579-022	Racecar
40G23/466579-023	Courtship
40G24/466579-024	Jam
40G25/466579-025	Sparrow

Nico - Maharam	
Ancillary/Seating/Workspaces	
54" wide	
63% wool	
21% polyester	
16% solution-dyed nylon	
ZNC01/466564-001	Alcazar
ZNC02/466564-002	Ironclad
ZNC03/466564-003	Tune
ZNC04/466564-004	Bridegroom
ZNC05/466564-005	Diode
ZNC06/466564-006	Jest
ZNC07/466564-007	Sanctuary
ZNC08/466564-008	Aquarius
ZNC09/466564-009	Houseboat
ZNC10/466564-010	Olympian
ZNC11/466564-011	Tennis
ZNC12/466564-012	Dressage
ZNC13/466564-013	Zing
ZNC14/466564-014	Bitterroot
ZNC15/466564-015	Gemini
ZNC16/466564-016	Posh
ZNC17/466564-017	Sizzle
ZNC18/466564-018	Cheerful
ZNC19/466564-019	Watermelon
ZNC20/466564-020	Toucan
ZNC21/466564-021	Rosin
ZNC22/466564-022	Jousting
ZNC23/466564-023	Jojoba
ZNC24/466564-024	Dromedary
ZNC25/466564-025	Toasty
ZNC26/466564-026	Casaba
ZNC27/466564-027	Greenhouse
ZNC28/466564-028	Sibyl
ZNC29/466564-029	Spearmint
ZNC30/466564-030	Pothos
ZNC31/466564-031	Calathea
ZNC32/466564-032	Landscape
ZNC33/466564-033	Espalier
ZNC34/466564-034	Gecko
ZNC35/466564-035	Meditation

Price category 5 continued on next page

- Maharam textiles are on assigned lead times [A](#).
- Fabric numbers are listed as Herman Miller fabric number/Maharam fabric number.

# Textile Colors

continued

## Price Category 5

continued

Summit	
Ancillary/Seating	
54" wide	
100% silicone	
Polyester knit backing	
3SU02	Oyster
3SU03	Zinc
3SU04	Sparrow
3SU07	Black
3SU09	Beachglass
3SU10	Midnight

Vionette - Geiger Textile	
Ancillary	
55" wide	
100% polyester	
1GJ01	White Sand Mix
1GJ02	Desert Mix
1GJ03	Light Gray Mix
1GJ04	Pewter Mix
1GJ05	Cobalt Mix
1GJ06	Prussian Blue Mix
1GJ07	Chocolate Mix
1GJ08	Champagne
1GJ09	Morning Sky
1GJ10	Aquatic
1GJ11	Sapphire
1GJ12	Midnight Blue
1GJ13	Shadow
1GJ14	Java
1GJ15	Carbon
1GJ16	Black
1GJ17	Claret
1GJ18	Poppy

## Price Category 6

Balance	
Seating	
For Embody® chairs	
100% polyester	
3512	Carbon
3513	Black

Outdoor Weave	
Ancillary	
For Eames® Aluminum Group	
Outdoor Chairs	
50% elastomeric	
50% polypropylene	
7203	Lead
7205	Graphite

## Price Category 7

Customer's Own Leather	
See Order Information in	
Appendices. Assigned lead-time	
textile. <sup>A</sup>	

Beck – Maharam	
Ancillary/Seating	
55" wide	
78% wool	
22% nylon	
ZB301/466571-001	Overshadow
ZB302/466571-002	Molecule
ZB303/466571-003	Zeitgeist
ZB304/466571-004	Blacksmith
ZB305/466571-005	Cornerstone
ZB306/466571-006	Chainmail
ZB307/466571-007	Buckram
ZB308/466571-008	Callisto
ZB309/466571-009	Interlude
ZB310/466571-010	Letterpress
ZB311/466571-011	Memoir
ZB312/466571-012	Litmus
ZB313/466571-013	Stoic
ZB314/466571-014	Inkpad
ZB315/466571-015	Praxis
ZB316/466571-016	Astute
ZB317/466571-017	Percolate
ZB318/466571-018	Halocline
ZB319/466571-019	Semblance
ZB320/466571-020	Loch
ZB321/466571-021	Lido
ZB322/466571-022	Underwater
ZB323/466571-023	Tetrapod
ZB324/466571-024	Nymph
ZB325/466571-025	Appalachian

Beck continued	
ZB326/466571-026	Menthol
ZB327/466571-027	Woodruff
ZB328/466571-028	Malachite
ZB329/466571-029	Botanist
ZB330/466571-030	Woodlet
ZB331/466571-031	Katydid
ZB332/466571-032	Exuberant
ZB333/466571-033	Retrospect
ZB334/466571-034	Lambic
ZB335/466571-035	Argil
ZB336/466571-036	Brushstroke
ZB337/466571-037	Candescent
ZB338/466571-038	Reedbuck
ZB339/466571-039	Clayware
ZB340/466571-040	Curio
ZB341/466571-041	Whimsy
ZB342/466571-042	Effervescent
ZB343/466571-043	Lingonberry
ZB344/466571-044	Resplendent
ZB345/466571-045	Hollyhock
ZB346/466571-046	Filigree
ZB347/466571-047	Plutonic
ZB348/466571-048	Foundry
ZB349/466571-049	Patisserie
ZB390	Gold 007/032/033 *
ZB391	Russet 036/040/039 *
ZB392	Indigo 008/013/014 *
ZB393	Forest 006/031/028 *

\* Colors available only on Girard Color Wheel Ottoman.

Price category 7 continued on next page

- Maharam textiles are on assigned lead times <sup>A</sup>.
- Fabric numbers are listed as Herman Miller fabric number/Maharam fabric number.

# Textile Colors

continued

## Price Category 7

continued

Appendix: Textile Colors

Bellano - Geiger Textile	
Ancillary	
55" wide	
75% wool	
10% linen	
8% nylon	
7% alpaca	
1AX01	Pearl
1AX02	Fog
1AX03	Fawn
1AX04	Pumice
1AX05	Pewter
1AX06	Atlantic
1AX07	Black Green
1AX08	Adriatic
1AX09	Coffee
1AX10	Charcoal
1AX11	Umber
1AX12	Magenta
1AX13	Bittersweet
1AX14	Sunflower

Capri - Geiger Textile	
Ancillary	
55" wide	
36% cotton	
32% acrylic	
24% rayon	
8% polyester	
PFOA-Free stain resistant finish	
Acrylic backing	
17201	Snow
17202	Stone
17203	Trench
17204	Graphite
17205	Anthracite
17206	Light Silver
17207	Russet
17208	Chestnut Brown
17209	Sand
17210	Sterling
17211	Cobalt
17212	Ink

Milaner - Geiger Textile	
Ancillary	
55" wide	
56% wool, 10% acrylic	
10% alpaca, 10% cotton	
8% nylon, 6% rayon	
17101	Linen
17102	Flax
17103	Bark
17104	Deep Navy
17105	Charcoal
17106	Medium Grey
17107	Ash
17108	Crimson

Panno di Dolce - Geiger Textile	
Ancillary	
55" wide	
65% wool	
20% nylon	
15% alpaca	
1AV01	Fog
1AV02	Dune
1AV03	Trench
1AV04	Flannel
1AV05	Charcoal
1AV06	Umber
1AV07	Deep Navy
1AV08	Graphite
1AV09	Orange
1AV10	Pink
1AV11	Deep Red
1AV12	Bright Green
1AV13	Cerulean Blue
1AV14	Deep Cerulean Blue

Pristina - Geiger Textile	
Ancillary	
55" wide	
37% wool	
25% viscose	
17% acrylic	
15% cotton	
6% polyester	
PFOA-Free stain resistant	
1JC01	Dove
1JC02	Goldstone
1JC03	Daybreak
1JC04	Pumice
1JC05	Cappuccino
1JC06	Gunmetal
1JC07	Caspian
1JC08	Café Noir

Resca - Geiger Textile	
Ancillary	
56" wide	
75% wool	
10% linen	
8% nylon	
7% alpaca	
1AW01	Fog
1AW02	Dune
1AW03	Trench
1AW04	Flannel
1AW05	Umber
1AW06	Bordeaux

Vesture - Geiger Textile	
Ancillary	
55" wide	
40% wool, 25% polyester	
20% silk, 15% nylon	
PFOA-Free stain resistant finish	
21701	Ashen
21702	Dark Blush
21703	Dusk
21704	Medium Gray
21705	Twilight

Wool Epinglé - Geiger Textile	
Ancillary	
54" wide	
100% wool	
16201	Swiss Red
16202	Orange
16203	Light Chestnut Brown
16204	Light Burnt Umber
16205	Pale Native Umber
16207	Grey
16208	Natier Blue
16209	Deep Cerulean Blue
16210	Anthracite
16211	Natural Native Umber
16212	Chestnut Brown

Wool Tweed - Geiger Textile	
Ancillary	
54" wide	
80% wool, 20% nylon	
16601	Trench
16602	Pewter
16603	Ruby
16604	Blue Gray
16605	Navy
16606	Umber
16607	Charcoal

- Maharam textiles are on assigned lead times [A](#).
- Fabric numbers are listed as Herman Miller fabric number/Maharam fabric number.

# Textile Colors

continued

## Price Category 8

Breeze - Maharam	
Workspaces	
120" wide	
65% FR polyester	
35% post-consumer recycled	
FR polyester	
1QG06/283817-006	Meteorite
1QG09/283817-009	Serum

Luce - Maharam	
Ancillary/Seating	
59" wide	
75% post-consumer recycled wool	
20% polyester	
5% nylon	
ZLU01/466566-001	Brioche
ZLU02/466566-002	Blanched
ZLU03/466566-003	Relic
ZLU04/466566-004	Sinter
ZLU05/466566-005	Scoria
ZLU06/466566-006	Austere
ZLU07/466566-007	Pigment
ZLU08/466566-008	Alkali
ZLU09/466566-009	Tidal
ZLU10/466566-010	Imbue
ZLU11/466566-011	Reservoir
ZLU12/466566-012	Brine
ZLU13/466566-013	Undertone
ZLU14/466566-014	Prelude
ZLU15/466566-015	Submerge
ZLU16/466566-016	Cypress
ZLU17/466566-017	Awash

Luce continued	
ZLU18/466566-018	Adriatic
ZLU19/466566-019	Province
ZLU20/466566-020	Virescent
ZLU21/466566-021	Nettle
ZLU22/466566-022	Agrarian
ZLU23/466566-023	Serpentine
ZLU24/466566-024	Laurel
ZLU25/466566-025	Clarion
ZLU26/466566-026	Gooseberry
ZLU27/466566-027	Swelter
ZLU28/466566-028	Etruscan
ZLU29/466566-029	Coulis
ZLU30/466566-030	Rubescient
ZLU31/466566-031	Akoya
ZLU32/466566-032	Radiant
ZLU33/466566-033	Regent
ZLU34/466566-034	Spectral
ZLU35/466566-035	Thistle

Tempo – Maharam	
Ancillary	
55" wide	
100% polyester	
Polyester backing	
26S01/466589-001	Chert
26S02/466589-002	Grandstand
26S03/466589-003	Restful
26S04/466589-004	Battleship
26S05/466589-005	Lavender
26S06/466589-006	Dockside
26S07/466589-007	Swimming
26S08/466589-008	Ambience
26S09/466589-009	Adornment
26S10/466589-010	Remedy
26S11/466589-011	Fang
26S12/466589-012	Inshore
26S13/466589-013	Camouflage
26S14/466589-014	Mesclun
26S15/466589-015	Farmland
26S16/466589-016	Tadpole
26S17/466589-017	Purr
26S18/466589-018	Snowman
26S19/466589-019	Beehive
26S20/466589-020	Gazelle
26S21/466589-021	Shiitake
26S22/466589-022	Flaxseed
26S23/466589-023	Crawdad
26S24/466589-024	Flowery
26S25/466589-025	Burgundy
26S26/466589-026	Rangoli
26S27/466589-027	Petunia
26S28/466589-028	Campsite

Whim	
Ancillary	
54" wide	
34% viscose	
33% acrylic	
17% wool	
8% polyester	
9DA01	Warm White
9DA02	Rye
9DA03	Mustard Seed
9DA04	Terra Cotta
9DA05	Fir
9DA06	Navy
9DA07	Pewter

Appendix: Textile Colors

- Maharam textiles are on assigned lead times <sup>A</sup>.
- Fabric numbers are listed as Herman Miller fabric number/Maharam fabric number.

# Textile Colors

continued

## Price Category 9

Appendix: Textile Colors

Alpaca Mohair - Geiger Textile	
Ancillary	
54" wide	
63% alpaca	
21% cotton, 16% polyester	
18510	Dune
18511	Trench
18512	Vicuna
18570	Sepia
18571	Umber
18580	Fog
18581	Flannel
18582	Charcoal

Campana – Maharam	
Ancillary/Seating	
59" wide	
85% wool	
15% nylon	
ZC001/466571-001	Viverine
ZC002/466571-002	Lithograph
ZC003/466571-003	Moonscape
ZC004/466571-004	Brevity
ZC005/466571-005	Linear
ZC006/466571-006	Hinterland
ZC007/466571-007	Mural
ZC008/466571-008	Sloe
ZC009/466571-009	Interstellar
ZC010/466571-010	Mythology
ZC011/466571-011	Scintillate
ZC012/466571-012	Succession
ZC013/466571-013	Visceral
ZC014/466571-014	Hemisphere
ZC015/466571-015	Troposphere
ZC016/466571-016	Skye
ZC017/466571-017	Seaward
ZC018/466571-018	Nemorous
ZC019/466571-019	Allegory
ZC020/466571-020	Olivine
ZC021/466571-021	Reptilian
ZC022/466571-022	Basil
ZC023/466571-023	Fanleaf
ZC024/466571-024	Beachgrass
ZC025/466571-025	Hayfield

Campana continued	
ZC026/466571-026	Freesia
ZC027/466571-027	Rhodium
ZC028/466571-028	Undercoat
ZC029/466571-029	Airbrush
ZC030/466571-030	Shellfish
ZC031/466571-031	Mojave
ZC032/466571-032	Renaissance
ZC033/466571-033	Decoupage
ZC034/466571-034	Outback
ZC035/466571-035	Millipede

Gemma – Maharam	
Ancillary/Seating	
55" wide	
85% wool	
15% nylon	
ZGE01/466568-001	Crinoline
ZGE02/466568-002	Angelic
ZGE03/466568-003	Savory
ZGE04/466568-004	Honeycomb
ZGE05/466568-005	Gilded
ZGE06/466568-006	Paddleboat
ZGE07/466568-007	Stagecoach
ZGE08/466568-008	Waterbuck
ZGE09/466568-009	Earnest
ZGE10/466568-010	Auric
ZGE11/466568-011	Carmine
ZGE12/466568-012	Serape
ZGE13/466568-013	Ferric
ZGE14/466568-014	Canyon
ZGE15/466568-015	Alembic
ZGE16/466568-016	Patio
ZGE17/466568-017	Sorrel
ZGE18/466568-018	Root

Gemma continued	
ZGE19/466568-019	Mansion
ZGE20/466568-020	Buff
ZGE21/466568-021	Starch
ZGE22/466568-022	Dawn
ZGE23/466568-023	Countryside
ZGE24/466568-024	Dewy
ZGE25/466568-025	Reliquary
ZGE26/466568-026	Deluge
ZGE27/466568-027	Overlay
ZGE28/466568-028	Electron
ZGE29/466568-029	Sheath
ZGE30/466568-030	Quietude
ZGE31/466568-031	Jargon
ZGE32/466568-032	Powder
ZGE33/466568-033	Tide
ZGE34/466568-034	Outwash
ZGE35/466568-035	Enamored
ZGE36/466568-036	Smitten
ZGE37/466568-037	Revere
ZGE38/466568-038	Mangosteen
ZGE39/466568-039	Allium
ZGE40/466568-040	Immense
ZGE41/466568-041	Chamber
ZGE42/466568-042	Cosmos
ZGE43/466568-043	Inkling
ZGE44/466568-044	Rainwater
ZGE45/466568-045	Shade
ZGE46/466568-046	Pendant
ZGE47/466568-047	Axial
ZGE48/466568-048	Fervent
ZGE49/466568-049	Legacy
ZGE50/466568-050	Caliber
ZGE51/466568-051	Temple
ZGE52/466568-052	Evenfall

Jasper - Maharam	
Ancillary/Seating	
53" wide	
55% wool	
27% solution-dyed nylon	
18% cotton	
ZJA01/466563-001	Thrill
ZJA02/466563-002	Anise
ZJA03/466563-003	Grapefruit
ZJA04/466563-004	Lifeguard
ZJA05/466563-005	Heartfelt
ZJA06/466563-006	Corsage
ZJA07/466563-007	Earthenware
ZJA08/466563-008	Bear
ZJA09/466563-009	Firelight
ZJA10/466563-010	Dreamcatcher
ZJA11/466563-011	Bobcat
ZJA12/466563-012	Glacial
ZJA13/466563-013	Vaporize
ZJA14/466563-014	Trapdoor
ZJA15/466563-015	Halcyon
ZJA16/466563-016	Observatory
ZJA17/466563-017	Steamboat
ZJA18/466563-018	Aquathlon
ZJA19/466563-019	Cloudless
ZJA20/466563-020	Briny
ZJA21/466563-021	Magical
ZJA22/466563-022	Picnic
ZJA23/466563-023	Herbage
ZJA24/466563-024	Pasture
ZJA25/466563-025	Courtyard
ZJA26/466563-026	Leapfrog

Price category 9 continued on next page

- Maharam textiles are on assigned lead times [A](#).
- Fabric numbers are listed as Herman Miller fabric number/Maharam fabric number.

# Textile Colors

continued

## Price Category 9

continued

Leather	
Ancillary/Seating approx. 50 sq. ft. per hide 100% leather	
2101	Ivory
2109	Black *
2110	Smoke
2111	Graphite
2112	Khaki
2113	Rattan
2114	Truffle
2115	Alpine
2116	Haze
2117	Sable Grey
2118	Dark Mineral **
2119	Dark Carbon ***
2120	Cranberry
2121	Deep Sea

\* Armpad color available on Aeron® Chair, Graphite.

\*\* Armpad color available on Aeron Chair, Mineral.

\*\*\* Armpad color available on Aeron Chair, Carbon.

## Price Category 10

Bristol Leather - Geiger Textile	
Ancillary approx. 55 sq. ft. per hide 100% leather	
5-507	Black
5-511	Putty
5-519	Hunter
5-520	White
5-521	Ivory
5-522	Parchment
5-537	Caribbean
5-546	Pumice
5-547	Smoke
5-548	Charcoal
5-549	Dark Shale
5-556	Downtown Grey
5-557	City Night
5-559	Ash Grey
5-563	Champagne
5-564	Chestnut Brown
5-565	Dark Sienna
5-566	Earthen
5-567	Desert
5-568	British Green
5-579	Paris Blue
5-583	Atlantic
5-592	Camel
5-594	Taupe
5-597	Pure *
5-598	Cream
5-600	Midnight Blue
5-603	Sangria
5-604	Swiss Red
5-605	Nordic Yellow
5-606	Sky Grey
5-608	Natural

\* Color not available on Saiba Chair.

Firma – Maharam	
Ancillary/Seating 55" wide 78% wool 22% nylon	
3KH01/466582-001	Wrath
3KH02/466582-002	Pantomime
3KH03/466582-003	Shaded
3KH04/466582-004	Prologue
3KH05/466582-005	Framework
3KH06/466582-006	Railroad
3KH07/466582-007	Grommet
3KH08/466582-008	Lunisolar
3KH09/466582-009	Snowpack
3KH10/466582-010	Coldsnap
3KH11/466582-011	Sealift
3KH12/466582-012	Brood
3KH13/466582-013	Intertidal
3KH14/466582-014	Confide
3KH15/466582-015	Secluded
3KH16/466582-016	Leisure
3KH17/466582-017	Portfolio
3KH18/466582-018	Strato
3KH19/466582-019	Fogbow
3KH20/466582-020	Snowcone
3KH21/466582-021	Kazoo
3KH22/466582-022	Esteem
3KH23/466582-023	Mackerel
3KH24/466582-024	Brooch
3KH25/466582-025	Caesious
3KH26/466582-026	Islet
3KH27/466582-027	Biosphere
3KH28/466582-028	Hilltop
3KH29/466582-029	Arboreal
3KH30/466582-030	Lineage
3KH31/466582-031	Comfrey
3KH32/466582-032	Circe
3KH33/466582-033	Ecosystem
3KH34/466582-034	Knack
3KH35/466582-035	Watt
3KH36/466582-036	Epiphany
3KH37/466582-037	Gamma
3KH38/466582-038	Taxicab
3KH39/466582-039	Varietal
3KH40/466582-040	Tale

Firma continued	
3KH41/466582-041	Elemental
3KH42/466582-042	Cuff
3KH43/466582-043	Emu
3KH44/466582-044	Tempeh
3KH45/466582-045	Tephra
3KH46/466582-046	Shellac
3KH47/466582-047	Emporium
3KH48/466582-048	Keratin
3KH49/466582-049	Camwood
3KH50/466582-050	Gloam
3KH51/466582-051	Novela
3KH52/466582-052	Fruitpunch
3KH53/466582-053	Decant
3KH54/466582-054	Milkshake
3KH55/466582-055	Metaphysic
3KH56/466582-056	Carafe
3KH57/466582-057	Voyager
3KH58/466582-058	Tenebrous
3KH59/466582-059	Subtext
3KH60/466582-060	Silent

Gemma Multi – Maharam	
Ancillary/Seating 55" wide 85% wool 15% nylon	
ZGF01/466569-001	Andromeda
ZGF02/466569-002	Dappled
ZGF03/466569-003	Lyra
ZGF04/466569-004	Flaunt
ZGF05/466569-005	Celluloid
ZGF06/466569-006	Hydrozoa
ZGF07/466569-007	Firefly
ZGF08/466569-008	Pisces
ZGF09/466569-009	Strath
ZGF10/466569-010	Erosion
ZGF11/466569-011	Cabaret
ZGF12/466569-012	Candytuft
ZGF13/466569-013	Juice
ZGF14/466569-014	Fairground
ZGF15/466569-015	Copperplate
ZGF16/466569-016	Sunbird
ZGF17/466569-017	Cinematic
ZGF18/466569-018	Clairvoyant

- Maharam textiles are on assigned lead times A.
- Fabric numbers are listed as Herman Miller fabric number/Maharam fabric number.

Price category 10 continued on next page

# Textile Colors

continued

## Price Category 10

continued

Appendix: Textile Colors

<b>Gemma Multi continued</b>	<b>Gemma Multi Reverse – Maharam</b>	<b>Gemma Multi Reverse continued</b>	<b>Gemma Multi Reverse continued</b>
ZGF19/466569-019 Crocus	Ancillary/Seating	ZGF78/466569-121 Roulette	ZGFA0/466569-143 Percolate
ZGF20/466569-020 Memoir	55" wide	Reverse	Reverse
ZGF21/466569-021 Roulette	85% wool	ZGF79/466569-122 Voltaic	ZGFA1/466569-144 Motor
ZGF22/466569-022 Voltaic	15% nylon	Reverse	Reverse
ZGF23/466569-023 Compote	ZGF58/466569-101 Andromeda	ZGF80/466569-123 Compote	ZGFA2/466569-145 Unicorn
ZGF24/466569-024 Lambent	Reverse	Reverse	Reverse
ZGF25/466569-025 Twister	ZGF59/466569-102 Dappled	ZGF81/466569-124 Lambent	ZGFA3/466569-146 Lobster
ZGF26/466569-026 Chronicle	Reverse	Reverse	Reverse
ZGF27/466569-027 Sidereal	ZGF60/466569-103 Lyra	ZGF82/466569-125 Twister	ZGFA4/466569-147 Rhododendron
ZGF28/466569-028 Tanzanite	Reverse	Reverse	Reverse
ZGF29/466569-029 Crystalize	ZGF61/466569-104 Flaunt	ZGF83/466569-126 Chronicle	ZGFA5/466569-148 Taffy
ZGF30/466569-030 Chromium	Reverse	Reverse	Reverse
ZGF31/466569-031 Pallium	ZGF62/466569-105 Celluloid	ZGF84/466569-127 Sidereal	ZGFA6/466569-149 Rishi
ZGF32/466569-032 Spectre	Reverse	Reverse	Reverse
ZGF33/466569-033 Courgette	ZGF63/466569-106 Hydrozoa	ZGF85/466569-128 Tanzanite	ZGFA7/466569-150 Backcountry
ZGF34/466569-034 Viper	Reverse	Reverse	Reverse
ZGF35/466569-035 Sunlit	ZGF64/466569-107 Firefly	ZGF86/466569-129 Crystalize	ZGFA8/466569-151 Buckthorn
ZGF36/466569-036 Heavenly	Reverse	Reverse	Reverse
ZGF37/466569-037 Vernal	ZGF65/466569-108 Pisces	ZGF87/466569-130 Chromium	ZGFA9/466569-152 Coniferous
ZGF38/466569-038 Cress	Reverse	Reverse	Reverse
ZGF39/466569-039 Limn	ZGF66/466569-109 Strath	ZGF88/466569-131 Pallium	ZGFB0/466569-153 Delphic
ZGF40/466569-040 Horseradish	Reverse	Reverse	Reverse
ZGF41/466569-041 Shandy	ZGF67/466569-110 Erosion	ZGF89/466569-132 Spectre	ZGFB1/466569-154 Hieroglyph
ZGF42/466569-042 Granary	Reverse	Reverse	Reverse
ZGF43/466569-043 Percolate	ZGF68/466569-111 Cabaret	ZGF90/466569-133 Courgette	ZGFB2/466569-155 Eiderdown
ZGF44/466569-044 Motor	Reverse	Reverse	Reverse
ZGF45/466569-045 Unicorn	ZGF69/466569-112 Candytuft	ZGF91/466569-134 Viper	ZGFB3/466569-157 Tanager
ZGF46/466569-046 Lobster	Reverse	Reverse	Reverse
ZGF47/466569-047 Rhododendron	ZGF70/466569-113 Juice	ZGF92/466569-135 Sunlit	
ZGF48/466569-048 Taffy	Reverse	Reverse	
ZGF49/466569-049 Rishi	ZGF71/466569-114 Fairground	ZGF93/466569-136 Heavenly	<b>Petra - Maharam</b>
ZGF50/466569-050 Backcountry	Reverse	Reverse	Ancillary/Seating
ZGF51/466569-051 Buckthorn	ZGF72/466569-115 Copperplate	ZGF94/466569-137 Vernal	55" wide
ZGF52/466569-052 Coniferous	Reverse	Reverse	70% wool
ZGF53/466569-053 Delphic	ZGF73/466569-116 Sunbird	ZGF95/466569-138 Cress	19% linen
ZGF54/466569-054 Hieroglyph	Reverse	Reverse	11% nylon
ZGF55/466569-055 Eiderdown	ZGF74/466569-117 Cinematic	ZGF96/466569-139 Limn	ZP401/466580-001 Hieroglyph
ZGF56/466569-056 Sandbar	Reverse	Reverse	ZP402/466580-002 Interior
ZGF57/466569-057 Tanager	ZGF75/466569-118 Clairvoyant	ZGF97/466569-140 Horseradish	ZP403/466580-003 Samovar
	Reverse	Reverse	ZP404/466580-004 Calcite
	ZGF76/466569-119 Crocus	ZGF98/466569-141 Shandy	ZP405/466580-005 Silversmith
	Reverse	Reverse	ZP406/466580-006 Rivet
	ZGF77/466569-120 Memoir	ZGF99/466569-142 Granary	ZP407/466580-007 Carpolite
	Reverse	Reverse	ZP408/466580-008 Bonbon

- Maharam textiles are on assigned lead times **A**.
- Fabric numbers are listed as Herman Miller fabric number/Maharam fabric number.

Price category 10 continued on next page



# Textile Colors

continued

## Price Category 10

continued

<b>Petra continued</b>	
ZP409/466580-009	Dreamy
ZP410/466580-010	Bejewel
ZP411/466580-011	Sashimi
ZP412/466580-012	Spirula
ZP413/466580-013	Chalet
ZP414/466580-014	Reindeer
ZP415/466580-015	Nostalgia
ZP416/466580-016	Trove
ZP417/466580-017	Narcissus
ZP418/466580-018	Yurt
ZP419/466580-019	Congee
ZP420/466580-020	Genepy
ZP421/466580-021	Herbaceous
ZP422/466580-022	Paddock
ZP423/466580-023	Precious
ZP424/466580-024	Biome
ZP425/466580-025	Tinted
ZP426/466580-026	Pelagic
ZP427/466580-027	Bluebill
ZP428/466580-028	Chicory
ZP429/466580-029	Eaglet
ZP430/466580-030	Permafrost
ZP431/466580-031	Atlantic
ZP432/466580-032	Airstream
ZP433/466580-033	Debonair

<b>Superweave - Maharam</b>	
Ancillary	
54" wide	
75% polyester	
25% cotton	
Z2203/466241-005	Sienna
Z2204/466241-002	Ochre
Z2207/466241-004	Marine
Z2208/466241-003	Olive
Z2220/466241-001	Orange and Pink

## Price Category 11

<b>Prone Leather - Maharam</b>	
Ancillary	
approx. 50 sq. ft. per hide	
100% leather	
protective top coat	
1NX01/700020-001	Lotus
1NX02/700020-002	Timbre
1NX03/700020-003	Essence
1NX04/700020-004	Script
1NX05/700020-005	Gambit
1NX06/700020-006	Obsidian
1NX07/700020-007	Sail
1NX09/700020-009	Vine
1NX10/700020-010	Yarrow
1NX13/700020-013	Balsa
1NX14/700020-014	Shore
1NX15/700020-015	Bricolage
1NX17/700020-017	Ledge
1NX19/700020-019	Mantra
1NX20/700020-020	Java
1NX21/700020-021	Lute
1NX22/700020-022	Glow
1NX23/700020-023	Hickory

<b>Tenera Leather - Geiger Textile</b>	
Ancillary	
approx. 55 sq. ft. per hide	
100% leather	
17501	Cement
17502	Marzipan
17503	Sunglow
17504	Raw Sienna
17505	Maple
17506	Poppy
17507	Salsa
17508	Cranberry
17509	Burnt Sienna
17510	Dark Chocolate
17511	Black
17512	Carbon
17513	Sapphire

## Price Category 12-13

No fabrics available at this time.

## Price Category 14

<b>Lanalux - Maharam</b>	
Ancillary	
54" wide	
100% wool	
Z1375/466240-005	Black/White
Z1378/466240-006	Olive/Black
Z1380/466240-001	Natural
Z1383/466240-002	Umber
Z1384/466240-007	Natural/Black
Z1386/466240-003	Orange
Z1387/466240-004	Crimson

Appendix: Textile Colors

- Maharam textiles are on assigned lead times [A](#).
- Fabric numbers are listed as Herman Miller fabric number/Maharam fabric number.

# Textile Colors

continued

## Price Category A

No fabrics available at this time.

## Price Category B

### Medium – Maharam

Ancillary/Seating/Workspaces  
54" wide  
100% polyester

VM01/463490-001	Raven
VM02/463490-002	Smoke
VM03/463490-003	Alloy
VM04/463490-004	Flax
VM07/463490-007	Espresso
VM14/463490-014	Laser
VM16/463490-016	Port
VM22/463490-022	Marina
VM29/463490-029	Pistachio
VM32/463490-032	Prospect
VM36/463490-036	Delight
VM39/463490-039	Nautical
VM40/463490-040	Pool
VM44/463490-044	Washed
VM45/463490-045	Sculpture
VM46/463490-046	Thatched
VM47/463490-047	Hike
VM48/463490-048	Tangle
VM49/463490-049	Pacific
VM50/463490-050	Cosmic
VM51/463490-051	Cascade
VM52/463490-052	Blackberry
VM53/463490-053	Nasturtium

### Messenger – Maharam

Ancillary/Seating/Workspaces  
54" wide  
78% post-industrial recycled polyester  
15% polyester, 7% nylon

TI07/458640-007	Shadow
TI08/458640-008	Bayou *
TI24/458640-024	Poppy
TI25/458640-025	Mao
TI29/458640-029	Onyx *
TI31/458640-031	Cloud *
TI38/458640-038	Depth *
TI40/458640-040	Nile *
TI41/458640-041	Azure *
TI45/458640-045	Cactus *
TI46/458640-046	Ice * **
TI48/458640-048	Neon
TI50/458640-050	Hydrangea
TI53/458640-053	Tangelo
TI54/458640-054	Lumine *
TI58/458640-058	Snow ** ***
TI60/458640-060	Peridot
TI61/458640-061	Capri *
TI62/458640-062	Ultramarine
TI63/458640-063	Squall
TI66/458640-066	Cassis
TI67/458640-067	Aster

### Messenger continued

TI69/458640-069	Cherry
TI70/458640-070	Vibrant
TI71/458640-071	Satsuma *
TI72/458640-072	Maize
TI76/458640-076	Fossil
TI77/458640-077	Ash
TI78/458640-078	Tusk
TI79/458640-079	Oyster **
TI81/458640-081	Husk
TI84/458640-084	Robust
TI85/458640-085	Beyond
TI86/458640-086	Voyage *
TI87/458640-087	Everglade
TI89/458640-089	Blanch ***
TI90/458640-090	Longspur
TI91/458640-091	Vireo
TI92/458640-092	Dipper
TI93/458640-093	Gale
TI94/458640-094	Hunter
TI95/458640-095	Lime
TI96/458640-096	Apple
TI97/458640-097	Krill
TI98/458640-098	Catalyst

\* Colors available on 20-day lead time.

\*\* Colors not available on Eames Molded Fiberglass and Molded Plastic Side Chairs.

\*\*\* Colors not available on Valor Seating.

- Maharam textiles are on assigned lead times A.
- Fabric numbers are listed as Herman Miller fabric number/Maharam fabric number.

# Textile Colors

continued

## Price Category C

Manner - Maharam	
Ancillary/Seating/Workspaces	
54" wide	
65% post-industrial recycled polyester	
35% post-consumer recycled polyester	
Z2701/466177-001	Magic
Z2702/466177-002	Carob
Z2703/466177-003	Porpoise
Z2704/466177-004	Flint
Z2705/466177-005	Hush *
Z2706/466177-006	Nuance
Z2711/466177-011	Ember
Z2712/466177-012	Wagon
Z2713/466177-013	Ablaze
Z2714/466177-014	Peel
Z2716/466177-016	Butterscotch
Z2717/466177-017	Harvest
Z2720/466177-020	Parakeet
Z2722/466177-022	Aquatic
Z2723/466177-023	Cottage
Z2724/466177-024	Dahlia
Z2725/466177-025	Vivid
Z2726/466177-026	Basin
Z2727/466177-027	Schooner
Z2728/466177-028	Slope
Z2729/466177-029	Silverpoint
Z2730/466177-030	Lattice
Z2731/466177-031	Smoky
Z2732/466177-032	Magnetic
Z2733/466177-033	Woad
Z2734/466177-034	Resolute
Z2735/466177-035	Cruise
Z2736/466177-036	Atmospheric
Z2737/466177-037	Cloudburst
Z2738/466177-038	Tidewater
Z2739/466177-039	Firth
Z2740/466177-040	Oceanside
Z2741/466177-041	Grandeur
Z2742/466177-042	Comfort
Z2743/466177-043	Dill
Z2744/466177-044	Poplar
Z2745/466177-045	Citronella
Z2746/466177-046	Passerine

Manner continued	
Z2747/466177-047	Southwest
Z2748/466177-048	Roseate
Z2749/466177-049	Charisma
Z2750/466177-050	Siltstone
Z2751/466177-051	Kimono
Z2752/466177-052	Valiant
Z2753/466177-053	Baroness
* Color not available on Eames Aluminum Group, Executive Chairs, Upholstered Molded Plywood Chairs, and Sofa Compact.	

Merit - Maharam	
Ancillary/Seating	
54" wide	
76% post-industrial recycled polyester	
24% polyester	
PFOA-Free stain resistant	
88Z01/466444-001	Trickle
88Z02/466444-002	Beluga
88Z03/466444-003	Gunmetal
88Z04/466444-004	Blackout
88Z05/466444-005	Superior
88Z06/466444-006	Ocean
88Z07/466444-007	Highborn
88Z08/466444-008	Immersed
88Z09/466444-009	Rainfall
88Z10/466444-010	Blizzard
88Z11/466444-011	Poolside
88Z12/466444-012	Steel
88Z13/466444-013	Zircon
88Z14/466444-014	Ripple
88Z15/466444-015	Aegean
88Z16/466444-016	Armada
88Z17/466444-017	Hedera
88Z18/466444-018	Rainforest
88Z19/466444-019	Gator
88Z20/466444-020	Vineyard
88Z21/466444-021	Pine
88Z22/466444-022	Kiwi
88Z23/466444-023	Kookaburra

Merit continued	
88Z24/466444-024	Bellini
88Z25/466444-025	Sunflower
88Z26/466444-026	Sandstorm
88Z27/466444-027	Mudder
88Z28/466444-028	Lynx
88Z29/466444-029	Farro
88Z30/466444-030	Manila
88Z31/466444-031	Starfish
88Z32/466444-032	Brass
88Z33/466444-033	Arrow
88Z34/466444-034	Gelato
88Z35/466444-035	Nectarine
88Z36/466444-036	Macaron
88Z37/466444-037	Alert
88Z38/466444-038	Goji
88Z39/466444-039	Cabernet
88Z40/466444-040	Eggplant
88Z41/466444-041	Hawk
88Z42/466444-042	Stag
88Z43/466444-043	Overcast

Metric - Maharam	
Ancillary/Seating/Workspaces	
54" wide	
51% post-industrial recycled polyester	
49% polyester	
Z302/466014-002	Fog
Z303/466014-003	Fleece
Z312/466014-012	Cardinal
Z313/466014-013	Lava
Z318/466014-018	Pollen
Z320/466014-020	Alligator
Z323/466014-023	Tar
Z324/466014-024	Anchor
Z326/466014-026	Admiral
Z327/466014-027	Seaport
Z328/466014-028	Scuba
Z329/466014-029	Skate
Z330/466014-030	Hopscotch
Z331/466014-031	Film
Z332/466014-032	Whale
Z333/466014-033	Downpour
Z334/466014-034	Midday

Metric continued	
Z335/466014-035	Talisman
Z336/466014-036	Hedgerow
Z337/466014-037	Snorkel
Z338/466014-038	Highway
Z339/466014-039	Canary
Z340/466014-040	Sunny
Z341/466014-041	Aztec
Z342/466014-042	Fruit
Z343/466014-043	Galah
Z344/466014-044	Kiln
Z345/466014-045	Moth

Murmur - Maharam	
Ancillary/Seating	
55" wide	
100% polyester	
PFOA-Free stain resistant	
8EY01/466446-001	Gust
8EY02/466446-002	Harmonica
8EY03/466446-003	Canopy
8EY04/466446-004	Dim
8EY05/466446-005	Peppercorn
8EY06/466446-006	Cauldron
8EY07/466446-007	Conquer
8EY08/466446-008	Rapids
8EY09/466446-009	Seawater
8EY10/466446-010	Baby
8EY11/466446-011	Elderberry
8EY12/466446-012	Iceberg
8EY13/466446-013	Tallgrass
8EY14/466446-014	Underground
8EY15/466446-015	Biome
8EY16/466446-016	Cask
8EY17/466446-017	Argan
8EY18/466446-018	Sundown
8EY19/466446-019	Ignite
8EY20/466446-020	Sultry
8EY21/466446-021	Sangria

- Maharam textiles are on assigned lead times [A](#).
- Fabric numbers are listed as Herman Miller fabric number/Maharam fabric number.

# Textile Colors

continued

Appendix: Textile Colors

## Price Category D

Bluff - Maharam
Ancillary/Seating
54" wide
100% polyurethane
Ink-resistant protective top coat
Polyester backing
81801/466489-001 Loom
81802/466489-002 Helm
81803/466489-003 Cruller
81804/466489-004 Folklore
81805/466489-005 Beguile
81806/466489-006 Sherpa
81807/466489-007 Teleport
81808/466489-008 Annex
81809/466489-009 Lorimer
81810/466489-010 Cinema
81811/466489-011 Zip
81812/466489-012 Coach
81813/466489-013 Supernova
81814/466489-014 Pirate
81815/466489-015 Academy
81816/466489-016 Disco
81817/466489-017 Equator
81818/466489-018 Brink
81819/466489-019 Scene
81820/466489-020 Petrichor
81821/466489-021 Exotic
81822/466489-022 Fauna
81823/466489-023 Calabash
81824/466489-024 Fuscous
81825/466489-025 Wildling
81826/466489-026 Blitz
81827/466489-027 Allspice
81828/466489-028 Lumos
81829/466489-029 Pilot
81830/466489-030 Jukebox
81831/466489-031 Dugout
81832/466489-032 Claret
81833/466489-033 Flamenco

Mode – Maharam
Ancillary/Seating/Workspaces
54" wide
80% post-consumer recycled polyester
20% polyester
PFOA-Free stain resistant finish
ZMD01/466337-001 Stroll
ZMD02/466337-002 Intaglio
ZMD03/466337-003 Ominous
ZMD04/466337-004 Machine
ZMD05/466337-005 Talus
ZMD06/466337-006 Marsh
ZMD07/466337-007 Hollow
ZMD08/466337-008 Sycamore
ZMD09/466337-009 Clavicle
ZMD10/466337-010 Billygoat
ZMD11/466337-011 Spindle
ZMD12/466337-012 Lemon
ZMD13/466337-013 Oxeye
ZMD14/466337-014 Henge
ZMD15/466337-015 Goldenrod
ZMD16/466337-016 Cottontail
ZMD17/466337-017 Lioness
ZMD18/466337-018 Oriole
ZMD19/466337-019 Rust
ZMD20/466337-020 Carotene
ZMD21/466337-021 Blush
ZMD22/466337-022 Vermilion
ZMD23/466337-023 Alder
ZMD24/466337-024 Kermes
ZMD25/466337-025 Barberrry
ZMD26/466337-026 Petal
ZMD27/466337-027 Valley
ZMD28/466337-028 Odyssey
ZMD29/466337-029 Ballpoint
ZMD30/466337-030 Toile
ZMD31/466337-031 Paradise

Mode continued
ZMD32/466337-032 Angelfish
ZMD33/466337-033 Denim
ZMD34/466337-034 Crush
ZMD35/466337-035 Jetty
ZMD36/466337-036 Saltwater
ZMD37/466337-037 Mallard
ZMD38/466337-038 Celtic
ZMD39/466337-039 Eucalyptus
ZMD40/466337-040 Bonsai
ZMD41/466337-041 Sassafras
ZMD42/466337-042 Yucca
ZMD43/466337-043 Lichen

Spiral - Maharam
Workspaces
66" wide
100% polyester
ZS301/901882-001 Chalk
ZS303/901882-003 Wheat
ZS304/901882-004 Mica
ZS305/901882-005 Pavement
ZS306/901882-006 Graphite

## Price Category E

Article – Maharam
Ancillary/Seating
54" wide
100% vinyl
ZAT08/458600-008 Marina
ZAT13/458600-013 Flume
ZAT14/458600-014 Storm
ZAT15/458600-015 Toast
ZAT19/458600-019 Fleece
ZAT22/458600-022 Stone
ZAT26/458600-026 Mercury
ZAT29/458600-029 Bluegrass
ZAT31/458600-031 Truffle
ZAT32/458600-032 Gravel
ZAT33/458600-033 Value
ZAT34/458600-034 Tint
ZAT35/458600-035 Snowflake
ZAT36/458600-036 Chalice
ZAT37/458600-037 Trail
ZAT38/458600-038 Pyramid
ZAT39/458600-039 Desert
ZAT40/458600-040 Lei
ZAT41/458600-041 Rouge
ZAT42/458600-042 Karma
ZAT43/458600-043 Opal
ZAT44/458600-044 Periwinkle
ZAT45/458600-045 Vampire
ZAT46/458600-046 Surf
ZAT47/458600-047 Plumage

Price category E continued on next page

- Maharam textiles are on assigned lead times [A](#).
- Fabric numbers are listed as Herman Miller fabric number/Maharam fabric number.

# Textile Colors

continued

## Price Category E

continued

Flock - Maharam
Workspaces
63" wide
100% polyester
ZF301/901892-001 Calm
ZF302/901892-002 Course
ZF303/901892-003 Highlight
ZF305/901892-005 Poppy
ZF306/901892-006 Briefcase
ZF307/901892-007 Monkstrap
ZF308/901892-008 Quag
ZF309/901892-009 Pistachio
ZF310/901892-010 Froth
ZF311/901892-011 Celadon
ZF312/901892-012 Highsea
ZF313/901892-013 China
ZF314/901892-014 Victorian
ZF315/901892-015 Commander
ZF316/901892-016 Raven
ZF317/901892-017 Aluminum

Micro – Maharam
Ancillary
54" wide
100% vinyl
ZMB01/466099-001 Muslin
ZMB04/466099-004 Basalt
ZMB06/466099-006 Phantom
ZMB07/466099-007 Depth
ZMB08/466099-008 Cottage
ZMB09/466099-009 Hunter
ZMB11/466099-011 Tomatillo
ZMB12/466099-012 Brew
ZMB14/466099-014 Tang
ZMB15/466099-015 Risk

Parallel – Maharam
Workspaces
66" wide
100% recycled polyester
TT03/901180-003 Fog
TT22/901180-022 Sterling
TT23/901180-023 Linen
TT24/901180-024 Pea
TT27/901180-027 Boulder
TT28/901180-028 Stream
TT29/901180-029 Shiitake
TT32/901180-032 Brandy
TT33/901180-033 Crater
TT36/901180-036 Quail

## Price Category F

Apt – Maharam
Ancillary/Seating
54" wide
100% polyurethane/silicone
Ink-resistant protective top coat
Polyester backing
82T12/466392-012 Iris
82T13/466392-013 Nocturnal
82T14/466392-014 Fluid
82T15/466392-015 Eden
82T16/466392-016 Galactic
82T17/466392-017 Shoreline
82T18/466392-018 Jade
82T19/466392-019 Garden
82T20/466392-020 Botanic
82T21/466392-021 Chartreuse
82T23/466392-023 Lyric
82T24/466392-024 Turmeric
82T25/466392-025 Bengal
82T26/466392-026 Core
82T27/466392-027 Mantle
82T28/466392-028 Sorbet
82T32/466392-032 Oak
82T33/466392-033 Castle
82T34/466392-034 Follow
82T35/466392-035 Elixir
82T36/466392-036 Charm
82T37/466392-037 Descend
82T38/466392-009 Sketch
82T39/466392-010 Glacier
82T40/466392-031 Fortress
82T41/466392-030 Lotus
82T42/466392-001 Coconut
82T43/466392-011 Cobblestone
82T44/466392-029 Bloom
82T45/466392-022 Crepe
82T46/466392-006 Hickory
82T47/466392-007 Constellation
82T48/466392-008 Labyrinth
82T49/466392-002 Vibe
82T50/466392-003 Stampede
82T51/466392-004 Lumber
82T52/466392-005 Gingerbread

Brindle - Maharam
Ancillary/Seating
58" wide
100% polyester
PFOA-free stain resistant
Acrylic backing
87101/466418-001 Calico
87102/466418-002 Mauve
87103/466418-003 Torch
87104/466418-004 Burnt
87105/466418-005 Barn
87106/466418-006 Pharaoh
87107/466418-007 Sandbur
87108/466418-008 Jungle
87109/466418-009 Inland
87110/466418-009 Seagrass
87111/466418-009 Watercolor
87112/466418-009 Aquarium
87113/466418-009 Drill

Chime - Maharam
Ancillary
54" wide
100% vinyl
V9M3/465350-003 Morel
V9MB/465350-011 Tranquil
V9M/465350-020 Slate
V9MV/465350-031 Verve
V9MW/465350-032 Understory

Price category F continued on next page

- Maharam textiles are on assigned lead times [A](#).
- Fabric numbers are listed as Herman Miller fabric number/Maharam fabric number.

# Textile Colors

continued

## Price Category F

continued

Appendix: Textile Colors

Conduit - Maharam	
Ancillary/Seating	
58" wide	
100% polyester	
PFOA-free stain resistant	
Acrylic backing	
87Z01/466428-001	Space
87Z02/466428-002	Syrup
87Z03/466428-003	Nimbus
87Z04/466428-004	Greystone
87Z05/466428-005	Fawn
87Z06/466428-006	Ghost
87Z07/466428-007	Caribbean
87Z08/466428-008	Canal
87Z09/466428-009	Bonfire

Emit – Maharam	
Workspaces	
54" wide	
55% post-industrial recycled polyester	
45% post-consumer recycled polyester	
PFOA-free stain resistant	
8EX01/466378-001	Wed
8EX02/466378-002	Zebra
8EX03/466378-003	Chiffon
8EX05/466378-005	Nectar
8EX06/466378-006	Elk
8EX08/466378-008	Goldenrod
8EX09/466378-009	Beached
8EX10/466378-010	Samba
8EX11/466378-011	Nest
8EX14/466378-014	Groove
8EX17/466378-017	Haiku
8EX18/466378-018	Bluefin
8EX19/466378-019	Flow
8EX20/466378-020	Xenon
8EX21/466378-021	Artem
8EX22/466378-022	Zen
8EX25/466378-025	Limeade

Instill – Maharam	
Ancillary/Seating	
54" wide	
100% polyurethane	
Ink-resistant protective top coat	
Polyester backing	
74M01/466351-001	Page
74M02/466351-002	Limestone
74M03/466351-003	Bobwhite
74M04/466351-004	Loafer
74M07/466351-007	Shaker
74M08/466351-008	Doe
74M09/466351-009	Ride
74M10/466351-010	Squire
74M11/466351-011	Tannin
74M12/466351-012	Vitis
74M14/466351-014	Quail
74M15/466351-015	Brittanic
74M16/466351-016	Narwhal
74M18/466351-018	Stowaway
74M19/466351-019	Koala
74M20/466351-020	Dorsal
74M21/466351-021	Stealth

Keen - Maharam	
Ancillary/Seating	
54" wide	
61% polyester	
39% polyolefin	
PFOA-Free stain resistant	
Acrylic backing	
89N01/466433-001	Gaur
89N02/466433-002	Lock
89N03/466433-003	Elk
89N04/466433-004	Oatmeal
89N05/466433-005	Lakefront
89N06/466433-006	Argent
89N07/466433-007	Coyote
89N08/466433-008	Eventide
89N09/466433-009	Canal
89N10/466433-010	Rosemary
89N11/466433-011	Herb
89N12/466433-012	Ruby
89N13/466433-013	Loganberry

Ledger – Maharam	
Ancillary/Seating	
54" wide	
100% polyurethane	
V9G1/463770-001	001
V9G2/463770-002	002
V9G3/463770-003	003
V9G4/463770-004	004
V9GG/463770-017	017
V9GQ/463770-025	025
V9GS/463770-026	026
V9GU/463770-028	028
V9GV/463770-029	029
V9GW/463770-030	030
V9GX/463770-031	031
V9GY/463770-032	032
V9G18/463770-042	042
V9G19/463770-043	043
V9G20/463770-044	044
V9G21/463770-045	045
V9G22/463770-046	046

Loop - Maharam	
Ancillary/Seating	
57" wide	
48% post-industrial recycled polyester	
26% polyester	
26% post-consumer recycled polyester	
PFOA-Free stain resistant	
Acrylic Backing	
ZLL01/466469-001	Opossum
ZLL02/466469-002	Foundation
ZLL03/466469-003	Naval
ZLL04/466469-004	Buoyant
ZLL05/466469-005	Mockingbird
ZLL06/466469-006	Dynasty
ZLL07/466469-007	Zori
ZLL08/466469-008	Wildfire
ZLL09/466469-009	Floral
ZLL10/466469-010	Penguin

Multiply - Maharam	
Ancillary/Seating	
58" wide	
57% post-consumer recycled polyester	
43% post-industrial recycled polyester	
PFOA-Free stain resistant	
Acrylic Backing	
82A01/466341-001	Winter
82A02/466341-002	Encore
82A03/466341-003	Swing
82A04/466341-004	Contrast
82A05/466341-005	Sterling
82A06/466341-006	Daze
82A07/466341-007	Sway
82A08/466341-008	Sailor
82A09/466341-009	Mystique
82A10/466341-010	Deep
82A11/466341-011	Craft
82A12/466341-012	Town
82A13/466341-013	Limit
82A14/466341-014	Tamale

Pitch - Maharam	
Ancillary	
54" wide	
100% vinyl	
ZPC04/466186-004	Pollen
ZPC07/466186-007	Apple
ZPC11/466186-011	Voyage
ZPC12/466186-012	Turquoise
ZPC14/466186-014	Inlet
ZPC15/466186-015	Captain
ZPC16/466186-016	Aura
ZPC17/466186-017	Coastal
ZPC18/466186-018	Fog
ZPC19/466186-019	Coal
ZPC21/466186-021	Mulberry
ZPC24/466186-024	Flame
ZPC26/466186-026	Tumbleweed
ZPC29/466186-029	Subtle
ZPC30/466186-030	Buff

- Maharam textiles are on assigned lead times [A](#).
- Fabric numbers are listed as Herman Miller fabric number/Maharam fabric number.

Price category F continued on next page

# Textile Colors

continued

## Price Category F

continued

Pepper - Maharam
Ancillary/Seating
58" wide
49% polyester
41% post-industrial recycled polyester
10% post-consumer recycled polyester
PFOA-Free stain resistant
Acrylic Backing
8LW01/466486-001 Dojo
8LW02/466486-002 Marengo
8LW03/466486-003 Harlequin
8LW04/466486-004 Pavlova
8LW06/466486-006 Achioté
8LW07/466486-007 Essence
8LW08/466486-008 Genome
8LW09/466486-009 Myriad
8LW10/466486-010 Terrarium

Scuba - Maharam
Ancillary
54" wide
100% polyurethane
V9B1/464930-001 Vanilla
V9B5/464930-005 Chinchilla
V9B6/464930-006 Mahogany
V9B7/464930-007 Jet
V9B8/464930-008 Charcoal
V9B9/464930-009 Dolphin
V9BA/464930-010 Drizzle
V9BC/464930-012 Conifer
V9BD/464930-013 Bottle
V9BF/464930-015 Tourmaline
V9BG/464930-016 Sapphire
V9BH/464930-017 Electric
V9BL/464930-020 Cabernet
V9BM/464930-021 Brick
V9BN/464930-022 Coral
V9BP/464930-023 Autumn

Strum - Maharam
Ancillary/Seating
54" wide
100% polyurethane with silane-based antimicrobial
Z3301/466122-001 Overcast
Z3302/466122-002 Ridge
Z3304/466122-004 Pigeon
Z3307/466122-007 Bur
Z3308/466122-008 Abalone
Z3312/466122-012 Lemongrass

## Price Category G

Compound - Maharam
Ancillary/Seating
54" wide
100% polyurethane with silane-based antimicrobial
ZC201/466196-001 Quartz
ZC203/466196-003 Weathered
ZC204/466196-004 Cliff
ZC205/466196-005 Espresso
ZC206/466196-006 Smolder
ZC207/466196-007 Blaze
ZC208/466196-008 Mandarin
ZC209/466196-009 Maple
ZC210/466196-010 Perennial
ZC211/466196-011 Mountainside
ZC212/466196-012 Tundra
ZC213/466196-013 Manatee
ZC214/466196-014 Marine
ZC215/466196-015 Twilight
ZC216/466196-016 Shelter
ZC217/466196-017 Vessel
ZC218/466196-018 Smoke
ZC219/466196-019 Fog

Fluent Crypton - Maharam
Ancillary
54" wide
52% polyester
31% post-industrial recycled polyester
17% post-consumer recycled polyester
ZFC01/466073-001 Lynx
ZFC12/466073-012 Bayou
ZFC13/466073-013 Bottle
ZFC14/466073-014 Cadet
ZFC22/466073-022 Turf
ZFC24/466073-024 Steady

Fold - Maharam
Seating
54" wide
100% polyurethane
Polyester backing
ZF101/466292-001 Jet
ZF102/466292-002 Chalk
ZF103/466292-003 Smoke
ZF105/466292-005 Fatigue
ZF106/466292-006 Splash
ZF107/466292-007 Apple
ZF108/466292-008 Moss
ZF110/466292-010 Midnight

Gild - Maharam
Ancillary/Seating
54" wide
100% non-phthalate vinyl
Ink-resistant protective top coat
Polyester backing
8AR01/466432-005 Grapevine
8AR02/466432-009 Frosting
8AR03/466432-007 Smokey
8AR04/466432-003 Skylight
8AR05/466432-011 Sandstone
8AR06/466432-004 Hurricane
8AR07/466432-002 Wreath
8AR08/466432-001 Rainforest
8AR09/466432-012 Fudge
8AR10/466432-010 Lantern
8AR11/466432-006 Planet
8AR12/466432-008 Reflection

Price category G continued on next page

- Maharam textiles are on assigned lead times [A](#).
- Fabric numbers are listed as Herman Miller fabric number/Maharam fabric number.

# Textile Colors

continued

## Price Category G

continued

Pare – Maharam	
Ancillary/Seating	
54" wide	
52% wool	
26% polyester	
22% nylon	
PFOA-free stain resistant finish	
ZPR01/466359-001	Polaris
ZPR04/466359-004	Fresco
ZPR06/466359-006	Wink
ZPR07/466359-007	Concord
ZPR08/466359-008	Strawberry
ZPR09/466359-009	Solar
ZPR10/466359-010	Amulet
ZPR11/466359-011	Zest
ZPR12/466359-012	Elmwood
ZPR13/466359-013	Thyme
ZPR17/466359-017	Blueberry

Runner - Maharam	
Ancillary/Seating	
54" wide	
57% post-industrial recycled polyester	
43% post-consumer recycled polyester	
ZRF01/466108-001	Bluff
ZRF03/466108-003	Grove
ZRF04/466108-004	Starboard
ZRF05/466108-005	Plot
ZRF06/466108-006	Carousel

Sudden – Maharam	
Ancillary	
54" wide	
100% polyurethane	
ZSD02/463000-002	002
ZSD03/463000-003	003
ZSD05/463000-005	005
ZSD06/463000-006	006
ZSD07/463000-007	007
ZSD08/463000-008	008
ZSD09/463000-009	009
ZSD10/463000-010	010
ZSD11/463000-011	011
ZSD13/463000-013	013
ZSD15/463000-015	015
ZSD16/463000-016	016
ZSD17/463000-017	017
ZSD18/463000-018	018
ZSD19/463000-019	019
ZSD20/463000-020	020
ZSD24/463000-024	024
ZSD27/463000-027	027
ZSD36/463000-036	036

## Price Category H

Anagram - Maharam	
Ancillary	
54" wide	
42% cotton	
32% polyester	
26% nylon	
ZAN01/466067-001	Quarry
ZAN02/466067-002	Hush
ZAN03/466067-003	Electric
ZAN04/466067-004	Range
ZAN05/466067-005	Settle

Circles – Maharam	
Ancillary/Seating	
55" wide	
70% cotton	
30% polyester	
ZT01/458310-001	Khaki
ZT02/458310-002	Fatigue
ZT03/458310-003	Document
ZT04/458310-004	Engine

Dot Pattern – Maharam	
Ancillary/Seating	
55" wide	
71% cotton	
29% polyester	
ZK01/458300-001	Document
ZK02/458300-002	Taupe
ZK04/458300-004	Red
ZK05/458300-005	Navy

Mechanism – Maharam	
Ancillary	
54" wide	
100% polyester	
ZMC01/465952-001	Mercury
ZMC10/465952-010	Pearl
ZMC11/465952-011	Bronze
ZMC13/465952-013	Titanium
ZMC15/465952-015	Tangerine
ZMC17/465952-017	Sprout

Mister – Maharam	
Ancillary	
54" wide	
67% solution-dyed acrylic	
33% solution-dyed polyester	
ZMG01/466178-001	Breeze
ZMG04/466178-004	Enliven
ZMG05/466178-005	Notice
ZMG06/466178-006	Azurite

Regatta – Maharam	
Ancillary	
54" wide	
65% solution-dyed acrylic	
35% solution-dyed polyester	
ZRT01/466189-001	Drift
ZRT02/466189-002	Parasol
ZRT04/466189-004	Swell

Small Dot Pattern – Maharam	
Ancillary/Seating	
55" wide	
71% cotton	
29% polyester	
ZL01/458320-001	Document
ZL02/458320-002	Sand
ZL03/458320-003	Khaki
ZL04/458320-004	Taupe
ZL05/458320-005	Charcoal
ZL06/458320-006	Document
	Reverse
ZL07/458320-007	Red
ZL08/458320-008	Yellow
ZL09/458320-009	Green

- Maharam textiles are on assigned lead times [A](#).
- Fabric numbers are listed as Herman Miller fabric number/Maharam fabric number.



# Textile Colors

continued

## Price Category I

Colorwheel – Maharam	
Ancillary	
54" wide	
62% cotton	
38% solution-dyed	
post-industrial recycled nylon	
ZCW02/466163-002	Pumice
ZCW03/466163-003	Viridian
ZCW06/466163-006	Charcoal
ZCW07/466163-007	Carbon

Cursive – Maharam	
Ancillary/Seating	
54" wide	
67% solution-dyed acrylic	
33% solution-dyed polyester	
PFOA-Free stain resistant	
7CW01/466335-001	Fast
7CW03/466335-003	Beachcomb
7CW05/466335-005	Swift
7CW07/466335-007	Inkwell
7CW08/466335-008	Rubber

Passage - Maharam	
Ancillary	
54" wide	
100% polyester	
59P01/466614-001	Mirage
59P02/466614-002	Poolside
59P03/466614-003	Cascade
59P04/466614-004	Lacinato
59P05/466614-005	Overstory
59P06/466614-006	Celadon
59P07/466614-007	Echo
59P08/466614-008	Bentonite
59P09/466614-009	Buttercup
59P10/466614-010	Maple
59P11/466614-011	Blossom
59P12/466614-012	Cloudberry
59P13/466614-013	Contessa
59P14/466614-014	Claret
59P15/466614-015	Katana

Study - Maharam	
Ancillary/Seating	
54" wide	
73% solution-dyed acrylic	
27% solution-dyed polyester	
ZSY01/466269-001	001
ZSY02/466269-002	002
ZSY03/466269-003	003
ZSY04/466269-004	004
ZSY05/466269-005	005

Tracery – Maharam	
Ancillary	
52" wide	
34% solution-dyed nylon	
26% wool	
21% polyester	
19% cotton	
acrylic backing	
PFOA-free stain resistant finish	
ZT501/466372-001	Birch
ZT502/466372-002	Sterling
ZT503/466372-003	Flint
ZT504/466372-004	Indigo
ZT505/466372-005	Arctic
ZT506/466372-006	Kelp
ZT507/466372-007	Melon
ZT508/466372-008	Poppy
ZT509/466372-009	Copper
ZT510/466372-010	Papaya
ZT511/466372-011	Sepia

## Price Category J

Fluted Silk – Maharam	
Ancillary	
54" wide	
85% silk	
8% cotton	
7% acrylic	
ZFK02/465982-002	Tarnish
ZFK05/465982-005	Calm
ZFK06/465982-006	Flaxen
ZFK10/465982-010	Noticed
ZFK11/465982-011	Moody
ZFK12/465982-012	Constant
ZFK13/465982-013	Seed
ZFK14/465982-014	Eternal
ZFK15/465982-015	Honor
ZFK17/465982-017	Cranach
ZFK20/465982-020	Discreet

Mikado – Maharam	
Ancillary	
54" wide	
79% cotton	
21% polyester	
V1901/459330-001	Umber
V1902/459330-002	Orange
V1903/459330-003	Ultramarine
V1904/459330-004	Pink
V1905/459330-005	Sepia

Trestle - Maharam	
Ancillary	
54" wide	
36% acrylic	
32% wool	
23% cotton	
9% polyester	
3WG01/466613-001	Loam
3WG02/466613-002	Rift
3WG03/466613-003	Fuse
3WG04/466613-004	Cumulus
3WG05/466613-005	Strand
3WG06/466613-006	Pomelo
3WG07/466613-007	Tawny
3WG08/466613-008	Sunstone
3WG09/466613-009	Kindling
3WG10/466613-010	Sidecar
3WG11/466613-011	Beak
3WG12/466613-012	Ficus
3WG13/466613-013	Hinge
3WG14/466613-014	Bluefish
3WG15/466613-015	Oblivion

- Maharam textiles are on assigned lead times [A](#).
- Fabric numbers are listed as Herman Miller fabric number/Maharam fabric number.

# Textile Colors

continued

Appendix: Textile Colors

## Price Category K

Checker – Maharam	
Ancillary	
55" wide	
77% cotton	
23% polyester	
V1201/459830-001 Emerald Light/ Ivory	
V1204/459830-004 Ultramarine/ Emerald	
V1206/459830-007 Sienna Dark/ Khaki	
V1207/459830-008 Black/White	
V1209/459830-009 Ultramarine/ Turquoise	
V1210/459830-010 Blue Gray/ Emerald	
V1211/459830-011 Olive/Pink	
V1212/459830-012 Magenta/ Orange	
V1213/459830-013 Crimson/ Orange	
Checker Split – Maharam	
Ancillary	
55" wide	
77% cotton	
23% polyester	
V1301/460290-01 Black/White	
Double Triangles – Maharam	
Ancillary	
55" wide	
77% cotton	
23% polyester	
V1401/459840-001 Black/White	
Facets – Maharam	
Ancillary	
55" wide	
77% cotton	
23% polyester	
V1501/459850-001 Black/White	

Isa – Maharam	
Ancillary	
59" wide	
85% wool	
15% nylon	
VKZ01/466624-001 Bashful	
VKZ02/466624-002 Median	
VKZ03/466624-003 Observe	
VKZ04/466624-004 Plains	
VKZ05/466624-005 Drawn	
VKZ06/466624-006 Connect	
VKZ07/466624-007 Fennel	
VKZ08/466624-008 Skyward	
VKZ09/466624-009 Oceanic	
VKZ10/466624-010 Neptune	
VKZ11/466624-011 Sprint	
VKZ12/466624-012 Ledge	
VKZ13/466624-013 Surround	
VKZ14/466624-014 Foretell	
VKZ15/466624-015 Lory	
VKZ16/466624-016 Dear	
VKZ17/466624-017 Foxtrot	
VKZ18/466624-018 Sincere	
VKZ19/466624-019 Begonia	
Optik – Maharam	
Ancillary	
55" wide	
76% cotton	
24% polyester	
ZQP01/459960-001 Sun Yellow/ Orange	
ZQP06/459960-006 White/Black	
Unisol – Maharam	
Ancillary	
55" wide	
61% rayon	
21% polyester	
18% cotton	
ZUN01/461160-001 Black/ White	

## Price Category L

Exaggerated Plaid – Maharam	
Ancillary	
59" wide	
100% wool	
ZEP01/466039-001 Glen	
ZEP02/466039-002 Brae	
ZEP03/466039-003 Firth	
Geometri – Maharam	
Ancillary	
55" wide	
77% cotton	
23% polyester	
ZGM02/459970-002 Red/ Carmine	
ZGM03/459970-003 Lilac/Blue	
ZGM04/459970-004 White/ Black	
Jacobs Coat – Maharam	
Ancillary	
54" wide	
92% wool	
8% nylon	
V1601/462270-001 Multicolored Bright *	
V1602/462270-002 Multicolored Neutral	
* Color available on Girard Color Wheel Ottoman.	
Millerstripe – Maharam	
Ancillary	
54" wide	
92% wool	
8% rayon	
V1701/462250-001 Multicolored Bright	
V1702/462250-002 Multicolored Neutral	

Minicheck - Maharam	
Seating	
55" wide	
78% cotton	
22% polyester	
PFOA-Free stain resistant finish	
ZMK01/466268-001 Black/ White	
Monk's Wool – Maharam	
Ancillary	
54" wide	
96% wool	
4% nylon	
ZMW01/457301-001 Tusk	
ZMW03/457301-003 Slate	
ZMW05/457301-005 Cherokee	
Pebble Wool – Maharam	
Ancillary	
54" wide	
90% wool	
10% nylon	
ZPW01/457401-001 Birch	
ZPW10/457401-010 Cottage	
ZPW13/457401-013 Eggshell	
ZPW14/457401-014 Whisper	
ZPW15/457401-015 Ceramic	
ZPW16/457401-016 Seamist	
ZPW17/457401-017 Armory	
ZPW18/457401-018 Glaze	
ZPW19/457401-019 Cordial	
Pebble Wool Multi – Maharam	
Ancillary	
54" wide	
97% wool	
3% nylon	
ZPM01/461200-001 Fawn	
ZPM02/461200-002 Slate	
ZPM05/461200-005 Moss	
ZPM06/461200-006 Tabasco	

Price category L continued on next page

- Maharam textiles are on assigned lead times A.
- Fabric numbers are listed as Herman Miller fabric number/Maharam fabric number.

# Textile Colors

continued

## Price Category L

continued

Quatrefoil – Maharam	
Ancillary	
54" wide	
75% cotton	
25% nylon	
V2101/459350-001	Silver
V2102/459350-002	Pink
V2103/459350-003	Crimson
V2104/459350-004	Emerald
V2105/459350-005	Violet

Repeat Classic Stripe – Maharam	
Ancillary	
55" wide	
47% cotton	
27% rayon	
26% polyester	
ZRS01/462170-001	Inca
ZRS02/462170-002	Pistachio
ZRS03/462170-003	Poppy
ZRS04/462170-004	Cadet
ZRS05/462170-005	Peacock

Repeat Dot Ring – Maharam	
Ancillary	
55" wide	
75% cotton	
25% polyester	
ZRR01/462150-001	Gold
ZRR04/462150-004	Pink
ZRR05/462150-005	Coral
ZRR07/462150-007	Gold
	Reverse
ZRR10/462150-010	Pink
	Reverse
ZRR11/462150-011	Coral
	Reverse

Stripes - Maharam	
Ancillary	
56" wide	
92% wool	
8% nylon	
ZSP01/463980-001	001
ZSP02/463980-002	002
ZSP03/463980-003	003
ZSP04/463980-004	004
ZSP05/463980-005	005
ZSP06/463980-006	006
ZSP07/463980-007	007
ZSP08/463980-008	008
ZSP09/463980-009	009
ZSP10/463980-010	010

Toostripe – Maharam	
Ancillary	
54" wide	
92% wool	
8% nylon	
V2201/462260-001	Orange Dark/ Crimson Dark
V2202/462260-002	Black/ Raw Umber
V2203/462260-003	Ochre Dark/ Sienna

## Price Category M

Fruit - Maharam	
Seating	
54" wide	
55% cotton	
32% nylon	
13% post-consumer recycled polyester	
PFOA-Free stain resistant finish	
Acrylic backing	
ZF201/466262-001	Opal
ZF202/466262-002	Lime
ZF203/466262-003	Olive
ZF204/466262-004	Sky
ZF207/466262-007	Russet

Names – Maharam	
Ancillary	
55" wide	
73% cotton	
27% polyester	
V1801/462510-001	Crimson On White
V1802/462510-002	Ultramarine On White
V1803/462510-003	Black On White

Ottoman Stripe – Maharam	
Ancillary	
58" wide	
92% wool	
8% nylon	
ZQN01/466142-001	Brass
ZQN02/466142-002	Cocoa
ZQN03/466142-003	Dusk
ZQN04/466142-004	Pistachio
ZQN05/466142-005	Apricot

Pressed Plaid – Maharam	
Ancillary	
54" wide	
100% wool	
T1101/466181-001	001
T1102/466181-002	002
T1103/466181-003	003
T1104/466181-004	004
T1105/466181-005	005
T1106/466181-006	006

Wool Striae – Maharam	
Ancillary	
54" wide	
100% wool	
T1201/466184-001	001
T1202/466184-002	002
T1203/466184-003	003
T1204/466184-004	004
T1205/466184-005	005
T1206/466184-006	006
T1207/466184-007	007

Appendix: Textile Colors

- Maharam textiles are on assigned lead times A.
- Fabric numbers are listed as Herman Miller fabric number/Maharam fabric number.

# Textile Colors

continued

Appendix: Textile Colors

## Price Category N

### Alpaca Epinglé - Maharam

Ancillary
55" wide
100% alpaca
ZAE01/465902-001 Vellum
ZAE02/465902-002 Slate
ZAE06/465902-006 Graphite
ZAE07/465902-007 Beignet

### Alpaca Velvet - Maharam

Ancillary
54" wide
100% alpaca
ZAV01/465901-001 Alpine
ZAV06/465901-006 Charcoal
ZAV07/465901-007 Pewter
ZAV08/465901-008 Squash
ZAV09/465901-009 Wallaby
ZAV10/465901-010 Brunia

### Bespoke Stripe - Maharam

Ancillary
56" wide
100% wool
ZBP01/463540-001 Navy
ZBP02/463540-002 Tobacco
ZBP03/463540-003 Chocolate
ZBP04/463540-004 Charcoal
ZBP05/463540-005 Black
ZBP06/463540-006 Pewter

### Herringbone Stripe - Maharam

Ancillary
57" wide
100% wool
ZKP01/465945-001 Granite
ZKP02/465945-002 Espresso
ZKP03/465945-003 Graphite
ZKP04/465945-004 Indigo
ZKP05/465945-005 Raven

### Point - Maharam

Ancillary
53" wide
97% rayon
3% nylon
ZPT01/466090-001 Ivory and Ember
ZPT02/466090-002 Black and Coral
ZPT03/466090-003 Slate and Khaki
ZPT04/466090-004 Black and Cobalt
ZPT05/466090-005 Black and Khaki
ZPT06/466090-006 Slate and Mandarin
ZPT07/466090-007 Slate and Black
ZPT08/466090-008 Brick and Greige
ZPT09/466090-009 Gold and Black
ZPT10/466090-010 Greige and Peat
ZPT11/466090-011 Peat and Mandarin
ZPT12/466090-012 Crimson
ZPT13/466090-013 Mandarin
ZPT14/466090-014 Citrus
ZPT15/466090-015 Grass
ZPT16/466090-016 Cyan
ZPT17/466090-017 Cobalt

### Wool Velvet - Maharam

Ancillary
54" wide
100% wool
ZWV01/466120-001 Plush
ZWV02/466120-002 Subdue
ZWV03/466120-003 Flagstone
ZWV04/466120-004 Nori
ZWV06/466120-006 Bridle
ZWV07/466120-007 Covert
ZWV08/466120-008 Gateway

## Price Category O

### Bavaria Stripe - Maharam

Ancillary
55" wide
77% polyester
23% cotton
ZBS02/466161-002 Unique

## Price Category P

### Big Stripe - Maharam

Ancillary
55" wide
92% wool
8% nylon
ZBR01/466174-001 Peacock
ZBR02/466174-002 Spring
ZBR03/466174-003 Umber
ZBR04/466174-004 Poppy
ZBR05/466174-005 Cobalt

### Epinglé Stripe - Maharam

Ancillary
50" wide
100% cotton
ZES01/466007-001 Caramel
ZES02/466007-002 Lead
ZES03/466007-003 Violet
ZES04/466007-004 Mahogany
ZES05/466007-005 Olive

### Layers Garden - Maharam

Ancillary
52" wide
96% wool
3% nylon
1% polyester
ZLY01/465916-001 Ivy/Bronze
ZLY02/465916-002 Putty/ Turquoise
ZLY03/465916-003 Pewter/ White
ZLY04/465916-004 Chocolate/ Lilac
ZLY05/465916-005 Peat/Copper

Price category P continued on next page

- Maharam textiles are on assigned lead times. <sup>A</sup>
- Fabric numbers are listed as Herman Miller fabric number/Maharam fabric number.

# Textile Colors

continued

## Price Category P

continued

Layers Park – Maharam
Ancillary
52" wide
95% wool
3% nylon
2% polyester
ZLP01/465918-001 Ash/Snow
ZLP02/465918-002 Mineral/Sky
ZLP03/465918-003 Poppy/ Melon
ZLP04/465918-004 Indigo/ White
ZLP05/465918-005 Earth/Cobalt

Layers Vineyard Large – Maharam
Ancillary
52" wide
95% wool
3% nylon
2% polyester
ZLV01/465921-001 Ivory/Onyx
ZLV02/465921-002 Slate/Azure
ZLV03/465921-003 Loden/Sky
ZLV04/465921-004 Taupe/ Crimson
ZLV05/465921-005 Black/ Mahogany

Layers Vineyard Small – Maharam
Ancillary
52" wide
92% wool
5% polyester
3% nylon
ZLS01/465920-001 Ochre/White
ZLS02/465920-002 Scarlet/ Peony
ZLS03/465920-003 Taupe/Violet
ZLS04/465920-004 Jade/ Turquoise
ZLS05/465920-005 Ginger/Rose

Mohair Supreme - Maharam
Ancillary
54" wide
100% mohair
ZMS02/451801-072 Stonehenge
ZMS06/451801-112 Slate *
ZMS07/451801-113 Rich Chocolate *
ZMS09/451801-126 Cayenne
ZMS10/451801-127 Cognac
ZMS12/451801-129 Peat *
ZMS15/451801-133 Abyss
ZMS16/451801-134 Intrigue
ZMS18/451801-136 Lupine *
ZMS28/451801-146 League
ZMS29/451801-147 Armory *
ZMS32/451801-150 Capiz
ZMS33/451801-151 Underneath
ZMS34/451801-152 Crescent
ZMS35/451801-153 National
ZMS36/451801-154 Rooftop
ZMS37/451801-155 Skewer
ZMS38/451801-156 Party
ZMS39/451801-157 Keepsake
ZMS40/451801-158 Travel
ZMS41/451801-159 Estate
ZMS42/451801-160 Grassland
ZMS43/451801-161 Limoncello
ZMS44/451801-162 Mango
ZMS45/451801-163 Doll
ZMS46/451801-164 Carousel
ZMS47/451801-165 Palette
ZMS48/451801-166 Brandy
ZMS49/451801-167 Aristocrat
ZMS50/451801-168 Soulmate
ZMS51/451801-169 Rosette

\* Colors available on Eames Lounge Chair and Ottoman.

## Price Category Q

A Band Apart – Maharam
Ancillary
56" wide
75% polyester
25% cotton
ZAB01/466000-001 Unique

Brushed Camel – Maharam
Ancillary
58" wide
100% baby camel hair
ZBA01/465977-001 Albino
ZBA02/465977-002 Natural

Deconstructed Rose – Maharam
Ancillary
55" wide
65% polyester
32% cotton
3% rayon
ZDS01/466086-001 Golden
ZDS02/466086-002 Vivid
ZDS03/466086-003 Earthen

Massive Paisley – Maharam
Ancillary
57" wide
76% polyester
24% cotton
ZMV01/465915-001 Ash
ZMV03/465915-003 Cardinal
ZMV06/465915-006 Night

The Firm – Maharam
Ancillary
56" wide
75% polyester
25% cotton
ZTF03/465999-003 Unique

## Price Category R

Borders – Maharam
Ancillary
53" wide
98% wool
2% polyester
ZBB01/466082-001 Natural
ZBB02/466082-002 Greige
ZBB03/466082-003 Charcoal
ZBB04/466082-004 Walnut

Stow Leather - Maharam
Ancillary
approx. 50 sq. ft. per hide
100% leather
protective top coat
ZSV01/700014-001 Opera
ZSV02/700014-002 Japonica
ZSV03/700014-003 Masquerade
ZSV04/700014-004 Laguna
ZSV05/700014-005 Jettison
ZSV06/700014-006 Razor
ZSV07/700014-007 Holiday
ZSV08/700014-008 Patchouli
ZSV09/700014-009 Macrame
ZSV10/700014-010 Grace
ZSV11/700014-011 Seraphim
ZSV12/700014-012 Ricotta
ZSV13/700014-013 Neroli
ZSV14/700014-014 Sultana
ZSV15/700014-015 Sundance
ZSV16/700014-016 Quince
ZSV17/700014-017 Babka
ZSV18/700014-018 Maitake
ZSV19/700014-019 Mercer
ZSV20/700014-020 Gaucho
ZSV21/700014-021 Chia
ZSV22/700014-022 Vanguard
ZSV23/700014-023 Zone
ZSV24/700014-024 Zeppelin

Price category R continued on next page

Appendix: Textile Colors

- Maharam textiles are on assigned lead times. <sup>A</sup>
- Fabric numbers are listed as Herman Miller fabric number/Maharam fabric number.

# Textile Colors

continued

Appendix: Textile Colors

## Price Category R

continued

Stow Leather <i>continued</i>	
ZSV25/700014-025	Clandestine
ZSV26/700014-026	Raven
ZSV27/700014-027	Cabana
ZSV28/700014-028	Rime
ZSV29/700014-029	Forsythia
ZSV30/700014-030	Panthera
ZSV31/700014-031	Dune
ZSV32/700014-032	Madera
ZSV33/700014-033	Russet
ZSV34/700014-034	Gala
ZSV35/700014-035	Heron

## Price Category S

Bavaria – Maharam	
Ancillary	
55" wide	
73% polyester	
27% cotton	
ZBV01/466162-001	Unique

## Price Category T

All Grain Leather – Edelman	
Ancillary	
approx. 50 sq. ft. per hide	
100% full-grain Aniline-dye cowhide	
VB01/AG01	Pitch Brown
VB02/AG02	White
VB03/AG03	Cloud
VB04/AG04	Shadow
VB05/AG05	Black
VB06/AG06	Baked Bean
VB07/AG07	Mildew
VB08/AG08	Soot
VB09/AG09	Blue Jeans
VB10/AG10	Merlot
VB11/AG11	Nutmeg
VB12/AG12	Butter
VB13/AG13	Cherry
VB14/AG14	Burnt Orange
VB15/AG15	Whiskey
VB17/AG17	Raw Silk
VB18/AG18	Balsa
VB19/AG19	Naturale
VB21/AG21	Greige
VB22/AG27	Latte
VB23/AG28	Coral
VB24/AG29	Rose
VB25/AG30	Zinnia
VB26/AG31	Iris
VB27/AG32	Daffodil

Hours – Maharam	
Ancillary	
56" wide	
95% wool	
3% nylon	
2% rayon	
ZKR01/466092-001	Day
ZKR02/466092-002	Night

## Price Category U

Layers Garden Double – Maharam	
Ancillary	
52" wide	
96% wool	
3% nylon	
1% polyester	
ZLD01/465917-001	Ash/ Quartz/ Grass
ZLD02/465917-002	Earth/ Chocolate/ Coral
ZLD03/465917-003	Black/ Navy/ Cobalt

Layers Park Double – Maharam	
Ancillary	
52" wide	
96% wool	
3% nylon	
1% polyester	
ZLB01/465919-001	Mineral/ Taupe/ Lemon
ZLB02/465919-002	Sienna/ Ginger/ Rose
ZLB03/465919-003	Black/ Peat/ Copper

- Maharam textiles are on assigned lead times. <sup>A</sup>
- Fabric numbers are listed as Herman Miller fabric number/Maharam fabric number.

# Textile Colors

continued

Price Category V-W	Price Category X	Price Category Y	Price Category Z
No fabrics available at this time.	<p><b>Eden – Maharam</b></p> <p>Ancillary 56" wide 83% polyester 17% cotton</p> <p>ZED01/466258-001 001 ..... ZED02/466258-002 002 ..... ZED03/466258-003 003 ..... ZED04/466258-004 004 ..... ZED05/466258-005 005 .....</p> <p><b>Foliage – Maharam</b></p> <p>Ancillary 56" wide 75% polyester 25% cotton</p> <p>ZFG02/466257-002 002 ..... ZFG04/466257-004 004 ..... ZFG05/466257-005 005 .....</p>	<p><b>Industry – Maharam</b></p> <p>Ancillary 55" wide 80% polyester 20% cotton</p> <p>ZND01/466255-001 001 .....</p>	<p><b>Agency – Maharam</b></p> <p>Ancillary 55" wide 75% polyester 25% cotton</p> <p>ZAG02/466001-002 002 ..... ZAG04/466001-004 004 ..... ZAG05/466001-005 005 ..... ZAG06/466001-006 006 ..... ZAG07/466001-007 007 ..... ZAG08/466001-008 008 .....</p>

Appendix: Textile Colors

- Maharam textiles are on assigned lead times. A
- Fabric numbers are listed as Herman Miller fabric number/Maharam fabric number.

# Textile Colors

continued

## Price Category 10M

Appendix: Textile Colors

### Pace Leather – Maharam

Ancillary

approx. 50 sq. ft. per hide

100% leather

ZPA01/700011-001	Whisper
ZPA02/700011-002	Shy
ZPA03/700011-003	Granite
ZPA04/700011-004	Misty
ZPA05/700011-005	Studio
ZPA06/700011-006	Throne
ZPA07/700011-007	Proper
ZPA08/700011-008	Huron
ZPA09/700011-009	Darkroom
ZPA10/700011-010	Bark
ZPA11/700011-011	Raspberry
ZPA12/700011-012	Sangria
ZPA13/700011-013	Admiral
ZPA14/700011-014	Juniper
ZPA15/700011-015	Regal
ZPA16/700011-016	Vapor
ZPA17/700011-017	Valley
ZPA18/700011-018	Bushel
ZPA19/700011-019	Heirloom
ZPA20/700011-020	Palomino
ZPA21/700011-021	Bamboo
ZPA22/700011-022	Saffron
ZPA23/700011-023	Tearose
ZPA24/700011-024	Canyon
ZPA25/700011-025	Bistro
ZPA26/700011-026	Toffee
ZPA27/700011-027	Rodeo
ZPA28/700011-028	Mudslide
ZPA29/700011-029	Greige
ZPA30/700011-030	Reflection
ZPA31/700011-031	Pure
ZPA32/700011-032	Desert
ZPA33/700011-033	Griffin
ZPA34/700011-034	Urbane
ZPA35/700011-035	Woodrose

- Maharam textiles are on assigned lead times. <sup>A</sup>
- Fabric numbers are listed as Herman Miller fabric number/Maharam fabric number.





For more information about our products and services or to see a list of dealers, please visit us at [HermanMiller.com](http://HermanMiller.com) or call (800) 851 1196.

© 2024 Herman Miller, Inc., Zeeland, Michigan

#### Distribution Rights

Working together since 1956, Herman Miller and Vitra are the authentic sources of designs by Charles and Ray Eames, Alexander Girard, and George Nelson. All the designs shown in this book are protected by law. Herman Miller has obtained all rights to make and sell these designs. Also, Herman Miller holds exclusive worldwide manufacturing and distribution rights for these products with the following exceptions:

Charles and Ray Eames, George Nelson, and Alexander Girard—Worldwide distribution rights for furniture in all areas except Europe and the Middle East. For those areas, please contact Vitra.

Isamu Noguchi—Worldwide distribution rights for the Noguchi Rudder Table. Distribution rights for the Noguchi Table in North America and Central America only. For all other areas, please contact Vitra.

Magis—Exclusive distribution rights in the US and Canada. For all other areas, please contact Magis.

© **HermanMiller**, 3D Intelligent, 8Z Pellicle, AO, Action Office, Aeron, Aside, Bubble Lamps, Canvas Office Landscape, Caper, Celle, Cosm, Co/Struc, Daisyone, Distil, Eames, Eco-Dematerialized, Embody, Envelop, Ethospace, Exclave, Fine-Tune, FlexFront, Flo, Formcoat, Formwork, Ground Cloth, Intent, Kinemat, Layout Studio, Lino, Live Unframed, Living Office, Maharam, Meridian, Mirra, Motia, Nelson, Pari, Pellicle, Perspectives, Plex, PostureFit, PostureFit SL, Public Office Landscape, Sayl, Setu, Striad, Tu, Ubi, Verus, Wishbone, Y-Tower and Zeph are among the registered trademarks of Herman Miller, Inc., and its owned subsidiaries.

™ About Face, AireWeave, Airia, Ambit, Asari Chair by HermanMiller, Backfit, Bublelactack, Burdick Group, Butterfly Back, Canvas Vista, Cellular Suspension, Commend, Compass, Connect, DOT, Duracare, Durawrap, EnhancedAccess, Everywhere, Flex-Edge, Flute, Harmonic, Headway, Herman Miller Select, Hopsak 2, Iota, Keyless Entry, Latitude, Logic Mini, Logic Power Access Solutions, Lyris, Lyris 2, Made-to-Measure Storage, Mora, Multiscrim, Nevi, OE1, OE1 Workspace Collection, Overlay, Pixelated Support, Pronta, Renew, Sense, Soft Pad, Stackable, Stackable Storage, Swoop, Thrive, Tone, TriFlex, Twist and Wireframe are among the trademarks of Herman Miller, Inc., and its owned subsidiaries.

SM Herman Miller Options is among the service marks of Herman Miller, Inc.

AAP™ is a trademark of Extron Electronics.

Alexander Girard® is a registered trademark of The Alexander Girard Estate.

Chemsurf® is a registered trademark of Wilsonart International.

Corian® is a registered trademark of E. I. du Pont de Nemours and Company Corporation.

Crypton® is a registered trademark of Crypton, Inc.

DACRON® is a registered trademark of INVISTA S.a r.l.

Danzer® is a registered trademark of Danzer Holding AG.

Decora® is a registered trademark of Leviton Manufacturing Co., Inc.

Edelman® Leather is a registered trademark of Edelman Leather, Inc.

Extron® is a registered trademark of RGB Systems, Inc.

FENIX NTM® is a registered trademark of Arpa Industriale S.p.A.

FLEXNET™ is a trademark of Milliken & Company.

Floor Saver Glide® is a registered trademark of Carpin Manufacturing, Inc.

Forest Stewardship Council® is a registered trademark of the Forest Stewardship Council A.C. (FSC). We are FSC® certified (FSC® C102895).

FSC® is a registered trademark of the Forest Stewardship Council A.C. (FSC).

Geiger® is a registered trademark, and Bumper™, Saiba™, and Ward Bennett™ are trademarks, of Geiger International.

Hang-It-All® is a registered trademark of Lucia Eames Demetrios, d.b.a. Eames Office.

Holophane® is a registered trademark of Holophane.

Ingeo™ is a trademark of Cargill Dow LLC.

iPad® and Mac mini® are registered trademarks of Apple Inc.

Leviton® is a registered trademark of Leviton Manufacturing Co., Inc.

LifeSize® is a registered trademark of LifeSize Communications, Inc.

Logitech G® is a registered trademark of Logitech International S.A.

Magis®, Bombo®, and Me Too® are registered trademarks of Magis S.p.A.

MicrobeCare™ is a trademark of Parasol Medical LLC.

Microsoft® and Natural® Keyboard are registered trademarks of Microsoft Corporation.

Noguchi® and the Noguchi table configuration (trade dress) are registered trademarks, and Rudder Table™ is a trademark, of The Isamu Noguchi Foundation and Garden Museum.

Place Textiles® is a registered trademark of Place Textiles.

Sunbrella® is a registered trademark of Glen Raven, Inc.

SuperSeat™ is a trademark of Dahti Seating, a division of ITW.

Valor™ is among the trademarks owned by Nemschoff, Inc.