



Prices effective July 5, 2023

Published October 2023

Setu® Chairs

Introduction	page 2
Setu® Chairs	3
Multipurpose Chair	5
Stools	7
Appendices	
20-Day or Less/Assigned Lead-Time Order Information	
Casters and Glides	
Fire Retardancy-Seating	
Proprietary Textiles Application Chart-Seating	
Proprietary Textile Colors-Seating	
Maharam® Application Chart-Seating	
Maharam Colors-Seating	
For the latest materials information, refer to the Materials pages on HermanMiller.com.	

Introduction

A Note on the Organization of This Book

There are a few signals that will help you understand the organization of this book. Once you know them, you should be able to find your way around easily.

Like a newspaper, this book is formatted with columns of text and illustrations that run vertically.

Information wraps from one column to the next and continues for as many pages as it needs to.

Black bars are clues.

A black bar at the top of a page signals the start of information about a product.

This information is divided into two sections, each signaled by a black bar. Product Information includes a description, additional notes, and dimensional drawings. Specification Information, which always begins at the top of a column, includes a series of steps. Each step represents a decision you need to make in order to complete your product number. Steps must be followed sequentially. The number of pages needed to complete information on a product varies; some will be complete in one page; others may fill three or four pages. Just continue going through the steps until you run into the next product, signaled by the black bar at the top of the page.

Black tabs running along the outside edge of the page help you locate what section you are in or what section you want to go to. You can thumb forwards or backwards to find a section; tabs and text appear on both sides of the page.

The additional pages in the back of the book include the appendices and indices. They are signaled by a long black bar running along the outside edge of the page.

The index is presented two ways.

The first index is in alphabetical order by product name. It can be helpful if you are new to the products and numbering scheme or if you are looking for a type of product, such as work chair or round table.

The second index is by product number. It lists, in alphanumeric order, the base product number, typically a five-digit number.

General Information

This book is effective July 5, 2023, subject to change without notice. Products may be purchased from authorized Herman Miller dealers who will quote prices upon request. For more information about our products and services or to see a list of dealers, visit www.HermanMiller.com.

All prices are list prices. Additional services, such as planning services, design, storage, and installation, are not included and must be added to these prices when the additional services are requested.

Illustrations, specifications, and prices are based on the latest information at the time of publication. The right is reserved to make changes at any time without notice in prices, fabrics, finishes, materials, specifications, and models, and also to discontinue models and finishes.

Dimensions shown in the drawings are engineering drawing dimensions rounded up to the nearest $\frac{1}{8}$ ". Product is shipped set up or knocked down. Products that include "Shipped knocked down" in the description require some assembly. If this statement does not appear in the description, the product is shipped assembled.

Service problems are normally handled by a Herman Miller authorized dealer. Where this cannot be accomplished on a local level, service problems should be referred to the Customer Care Representative for your region, Herman Miller, Inc., Zeeland, Michigan 49464.

20-Day or Less/Assigned Lead-Time Shipments

All products and options in this price book not designated by an Assigned Program icon  will ship in **20 business days or less** after being acknowledged by Herman Miller.

Products and options designated by an  are on the assigned lead-time program and may ship in 20 days, less than 20 days, or more than 20 days from order acknowledgement.

Multipurpose Chair

Lounge Chair and Ottoman

Stools

Multipurpose Chair

CQ51F
 CQ51M
 CQ52F
 CQ52M
 CQ53F
 CQ53M



Product Information

Description

This multipurpose chair has a one-piece Lyris 2™ suspension or suspended upholstery between outer composite polymer frames. The Kinematic Spine™ technology is integrated into the chair's back frames to allow for varying recline positions and continuous support. The silver alloy base material is a durable and anti-corrosive aluminum, eliminating the need for polishing or protective coatings. The chair has a standard-height or high-height pneumatic height adjustment.

Base choices include a 5-star base with casters or a 4-star base with glides.

Arm choices include no arms or fixed-height ribbon arms.

Notes

Refer to Casters and Glides appendix to match caster with appropriate floor type. Hard wheel casters must be used on carpet surfaces only. Optional top corner bumpers are inserted into the left and right top edge of chair to protect Lyris 2™ from rubbing against walls or panels. Top bumpers can also be retrofitted when ordered as a service part. MicrobeCare™ is an antimicrobial coating that can be applied to a wide variety of Herman Miller Group surfaces to protect products from mold, mildew, algae, and bacteria that cause deterioration, discoloration, odors, and stains.

MicrobeCare™ is a US Environmental Protection Agency (EPA) registered nonpublic health antimicrobial.

MicrobeCare™ is applied to the major touchpoints, including the seat, backrest, arms, armrests, frame and adjustment controls.

Dimensions

Standard-Height

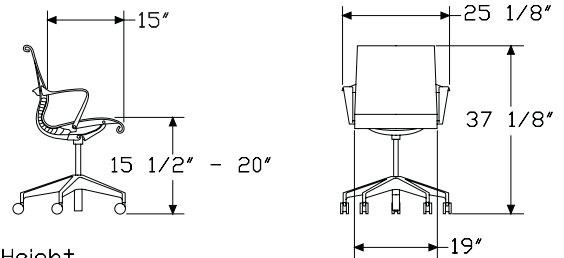

High-Height

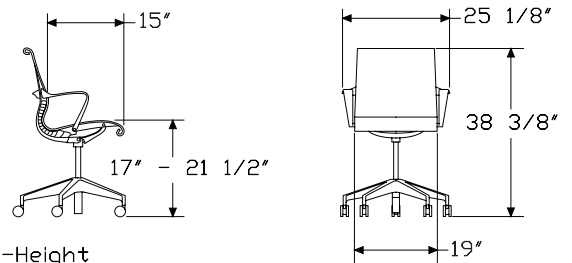

Fixed-Height

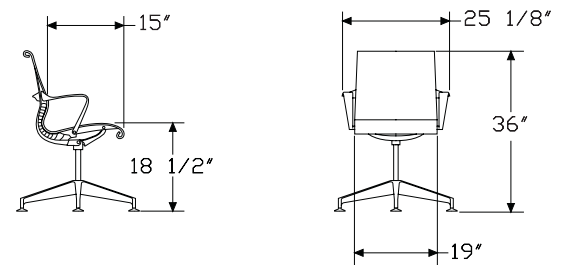

Multipurpose Chair *continued*

Specification Information		
Step 1.		
CQ5		
Step 2. Base Type/Height Adjustment		
1	5-star base, standard-height range	+\$1181
2	5-star base, high-height range	+\$1181
3	4-star base, swivel, fixed height	+\$1142
Step 3. Seat/Back Material		
M	lyris 2™ suspension seat and back	+\$0
F	suspended upholstery seat and back	+\$355
Step 4. Arms		
N	no arms	+\$0
A	ribbon arms	+\$102
Step 5. Frame Finish		
<i>For lyris 2™ suspension seat and back (M)</i>		
G1	graphite	+\$0
5B	java	+\$30
JH	chino	+\$30
SG	slate grey	+\$30
98	studio white	+\$85
MG1	graphite with MicrobeCare™ A	+\$70
M5B	java with MicrobeCare™ A	+\$100
MJH	chino with MicrobeCare™ A	+\$100
MSG	slate grey with MicrobeCare™ A	+\$100
M98	studio white with MicrobeCare™ A	+\$155
<i>For suspended upholstery seat and back (F)</i>		
G1	graphite	+\$0
5B	java	+\$30
JH	chino	+\$30
SG	slate grey	+\$30
98	studio white	+\$85
MG1	graphite with MicrobeCare™ A	+\$70
M5B	java with MicrobeCare™ A	+\$100
MJH	chino with MicrobeCare™ A	+\$100
MSG	slate grey with MicrobeCare™ A	+\$100
M98	studio white with MicrobeCare™ A	+\$155
Step 6. Base Finish		
L7	silver alloy	+\$0
G1	graphite	+\$50
5Y	semi-polished	+\$90

Step 7. Casters/Glides		
<i>For 5-star base, standard-height range (1) or 5-star base, high-height range (2)</i>		
C9	2½" braking caster, black yoke, hard floors or carpet	+\$50
HCC	2½" caster, low roll resistance, black yoke, hard floors or carpet	+\$0
OC	2½" caster, medium roll resistance with quiet roll technology, black yoke, hard floors or carpet	+\$45
<i>For 4-star base, swivel, fixed height (3)</i>		
X8	glide, low profile, hard floors or carpet	+\$0
Step 8. Bumper		
<i>For lyris 2™ suspension seat and back (M)</i>		
NNN	none	+\$0
BMP	top corner bumpers	+\$10
Step 9. Suspension Material		
<i>See application chart and textiles list for material usage and numbers. First 2 digits of number indicate material; remaining 2 digits indicate color.</i>		
<i>For lyris 2™ suspension seat and back (M)</i>		
Price Category 1		+\$0
<i>For suspended upholstery seat and back (F)</i>		
Price Category 1		+\$0
Price Category 2		+\$24
Price Category 3		+\$54
Price Category 4		+\$78
Price Category 5		+\$102
Price Category 7		+\$222
Price Category 8		+\$293
Price Category 9		+\$545
Price Category 10		+\$656
Price Category B		+\$108
Price Category C		+\$126
Price Category F		+\$180
Price Category H		+\$324
Price Category I		+\$390
Price Category J		+\$468

Stool

CQ79F
CQ79M

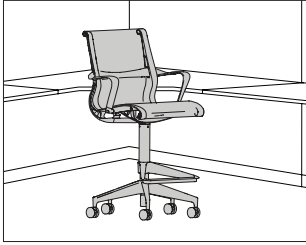

Product Information

Description

This stool has a one-piece Lyris 2™ suspension or suspended upholstery between outer composite polymer frames. The Kinematic Spine™ technology is integrated into the chair's back frames to allow for varying recline positions and continuous support. The silver alloy base material is a durable and anti-corrosive aluminum, eliminating the need for polishing or protective coatings. The stool offers a pneumatic height adjustment with one height option. The stool has a seat height range of 26³/₈" to 34¹/₄", with a height range of 7⁷/₈".

The silver alloy footrest is stationary and travels with the cylinder.

Base choices include a 5-star base with casters or glides.

Arm choices include no arms or fixed-height ribbon arms.

Notes

For information on casters and glides, see Casters and Glides in Appendices.

Optional top corner bumpers are inserted into the left and right top edge of chair to protect Lyris 2™ from rubbing against walls or panels.

Top bumpers can also be retrofitted when ordered as a service part.

MicrobeCare™ is an antimicrobial coating that can be applied to a wide variety of Herman Miller Group surfaces to protect products from mold, mildew, algae, and bacteria that cause deterioration, discoloration, odors, and stains.

MicrobeCare™ is a US Environmental Protection Agency (EPA) registered nonpublic health antimicrobial.

MicrobeCare™ is applied to the major touchpoints, including the seat, backrest, arms, armrests, frame and adjustment controls.

Dimensions

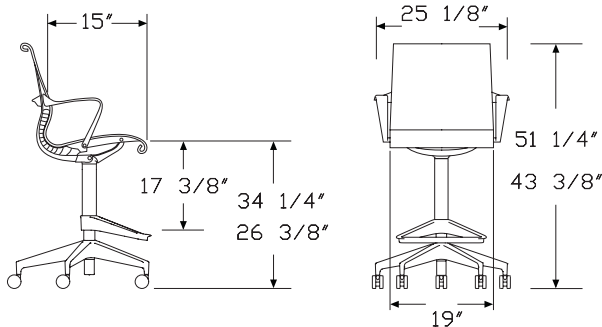

Specification Information

Step 1.

CQ7

Step 2. Base Type/Height Adjustment

9 5-star base, stool-height range +\$1719

Step 3. Seat/Back Material

M lyris 2™ suspension seat and back +\$0

F suspended upholstery seat and back +\$355

Step 4. Arms

N no arms +\$0

A ribbon arms +\$102

Step 5. Frame Finish

For lyris 2™ suspension seat and back (M)

G1 graphite +\$0

5B java +\$30

JH chino +\$30

SG slate grey +\$30

98 studio white +\$85

MG1 graphite with MicrobeCare™ **A** +\$70

M5B java with MicrobeCare™ **A** +\$100

MJH chino with MicrobeCare™ **A** +\$100

MSG slate grey with MicrobeCare™ **A** +\$100

M98 studio white with MicrobeCare™ **A** +\$155

For suspended upholstery seat and back (F)

G1 graphite +\$0

5B java +\$30

JH chino +\$30

SG slate grey +\$30

98 studio white +\$85

MG1 graphite with MicrobeCare™ **A** +\$70

M5B java with MicrobeCare™ **A** +\$100

MJH chino with MicrobeCare™ **A** +\$100

MSG slate grey with MicrobeCare™ **A** +\$100

M98 studio white with MicrobeCare™ **A** +\$155

Step 6. Column Finish

For studio white (98) or studio white with MicrobeCare™ (M98)

98 studio white +\$0

Stool *continued*

Setu® Stools

For graphite (G1) or graphite with MicrobeCare™ (MG1)

G1 graphite +\$0

For java (5B), chino (JH), slate grey (SG), java with MicrobeCare™ (M5B), chino with MicrobeCare™ (MJH), or slate grey with MicrobeCare™ (MSG)

BK black +\$0

Step 7. Base Finish

For studio white (98) or black (BK)

L7 silver alloy +\$0

5Y semi-polished +\$90

For graphite (G1)

L7 silver alloy +\$0

G1 graphite +\$50

5Y semi-polished +\$90

Step 8. Casters/Glides

C9 2½" braking caster, black yoke, hard floors or carpet +\$50

OC 2½" caster, medium roll resistance with quiet roll technology, black yoke, hard floors or carpet +\$45

X8 glide, low profile, hard floors or carpet +\$0

HCC 2½" caster, low roll resistance, black yoke, hard floors or carpet +\$0

Step 9. Bumper

For lyris 2™ suspension seat and back (M)

NNN none +\$0

BMP top corner bumpers +\$10

Step 10. Suspension Material

See application chart and textiles list for material usage and numbers. First 2 digits of number indicate material; remaining 2 digits indicate color.

For lyris 2™ suspension seat and back (M)

Price Category 1 +\$0

For suspended upholstery seat and back (F)

Price Category 1 +\$0

Price Category 2 +\$24

Price Category 3 +\$54

Price Category 4 +\$78

Price Category 5 +\$102

Price Category 7 +\$222

Price Category 8 +\$293

Price Category 9 +\$545

Price Category 10 +\$656

Price Category B +\$82

Price Category C +\$112

Price Category F +\$180

Price Category H +\$324



Price Category I +\$390

Price Category J +\$468

20-Day or Less/Assigned Lead-Time Order Information

20-Day or Less and Assigned Lead-Time Programs

20-day or less and assigned lead-time products are designed for established Herman Miller dealers with pre-approved credit.

Products are distributed from multiple manufacturing facilities across the United States. All products and options not designated by an Assigned Lead-Time icon  will ship in 20 business days or less after being acknowledged by Herman Miller. Products and options designated by an  are on the assigned lead-time program and will ship in 20 days, less than 20 days, or more than 20 days from order acknowledgement.

Ordering Procedure

Please place orders through Order Manager. If this is not available to you, place orders through mail or fax. Verbal purchase orders will not be accepted.

Order Entry fax number for Meridian®

Filing and Storage: (616) 846 9236.

Order Entry fax number for all other products:

(616) 654 3085.

For more information, contact your Customer Care representative at:
(866) 854 3048 ext 3400.

Shipments and Delivery

Per Herman Miller Terms and Conditions.

Changes and Cancellation

Per Herman Miller Terms and Conditions.



Casters and Glides

▲	WARNING	▲
Depending on the floor surface, chair may unexpectedly roll away from user when entering or exiting the chair, possibly leading to unexpected injury. Please refer to descriptions of floor types when selecting casters.		

32 Caster

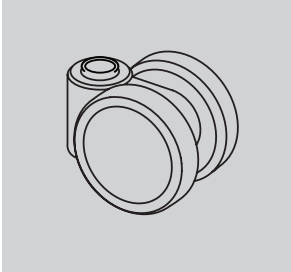

1⁷/₈-inch-diameter hard double-wheel caster; black nylon wheels and yoke; for use on carpet only

Applicable on:
Sayl® Chairs

BB Caster

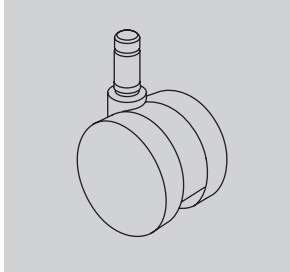

2¹/₂-inch-diameter hard double-wheel caster; black nylon wheels and yoke; for use on carpet only

Applicable on:
Asari Chair by Herman Miller™
New Aeron® Chairs
Caper® Chairs
Embody® Chairs
Fuld Nesting Chairs
Lino™ Chairs
Sayl Chairs
Mirra® 2 Chairs, Verus™ Chairs

BSC Caster

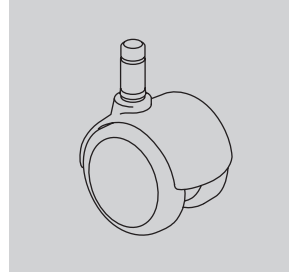

2-inch-diameter double-wheel caster; black nylon wheels and hood; soft polyurethane tread; for use on hard floors or carpet

Applicable on:
Eames® Aluminum Group
Eames Executive Chairs
Eames Soft Pad Group
Eames Task Chairs

C9 Caster

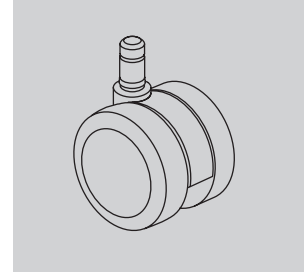

2¹/₂-inch-diameter double-wheel caster; black nylon wheels and yoke; soft polyurethane tread; internal brake; for use on hard floors or carpet

Applicable on:
Caper Chairs
Embody Chairs
Lino Chairs
Mirra 2 Chairs
Sayl Chairs
Setu® Chairs
Verus Chairs

49 Caster

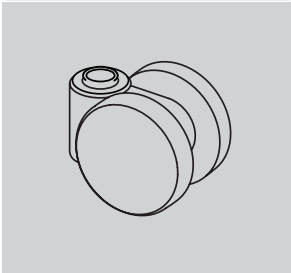

1⁷/₈-inch-diameter soft double-wheel caster; black nylon wheels and yoke; for use on hard floors or carpet

Applicable on:
Sayl Chairs

BKS Caster

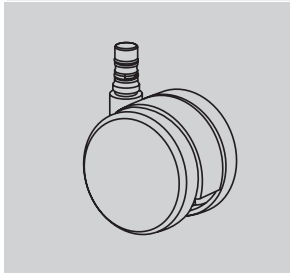

2¹/₂-inch-diameter hard double-wheel caster; black yoke; quiet roll technology; for use on carpet only

Applicable on:
Cosm™ Chairs

C7 Caster

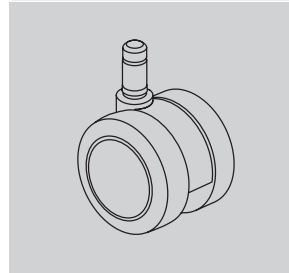

2¹/₂-inch-diameter double-wheel caster; black nylon wheels and yoke; soft polyurethane tread; for use on hard floors or carpet

Applicable on:
Asari Chair by Herman Miller™
New Aeron Chairs
Caper Chairs
Embody Chairs
Fuld Nesting Chairs
Lino Chairs Sayl Chairs
Mirra 2 Chairs Verus Chairs

CSQ Caster

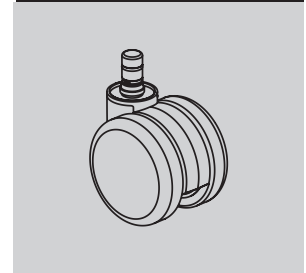

2¹/₂-inch-diameter double-wheel caster; color-matched nylon wheels and yoke; soft polyurethane tread; for use on hard floors or carpet

Applicable on:
Zeph™ Chairs

Casters and Glides

continued

DC1 Caster

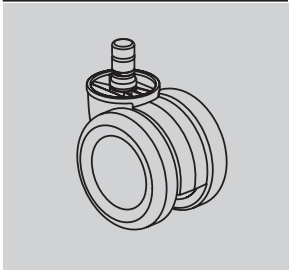

2¹/₂-inch-diameter double-wheel braking caster; black nylon wheels and yoke; for use on hard floors or carpet; quiet roll technology

Applicable on:

New Aeron Chairs

H9 Caster

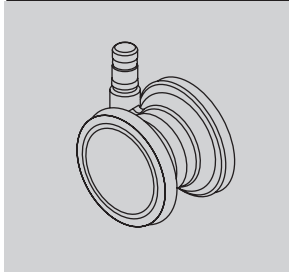

2¹/₂-inch-diameter double-wheel caster; clear polycarbonate wheels; nylon yoke; soft polyurethane tread; for use on carpet only

Applicable on:

Embody Chairs

MD Caster

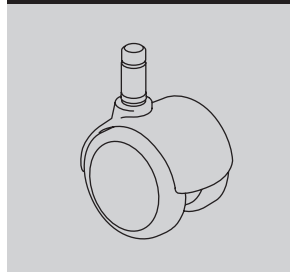

2-inch-diameter double-wheel caster; black nylon wheels with integral chrome hood; soft polyurethane tread; for use on hard floors or carpet

Applicable on:

Eames® Aluminum Group
Eames Executive Chairs
Eames Soft Pad Group
Eames Task Chairs

OC Caster

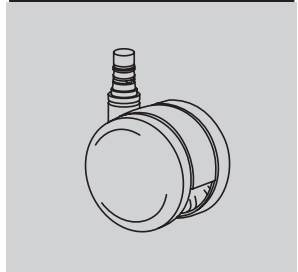

2¹/₂-inch-diameter double-wheel medium roll-resistant caster; black nylon wheels and yoke; soft polyurethane tread; for use on hard floors or carpet; quiet roll technology

Applicable on:

Cosm Chairs
Fuld Nesting Chairs
Setu Chairs

DS Caster

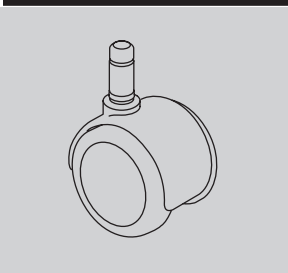

2-inch-diameter soft double-wheel braking caster; black nylon wheels and hood; for use on hard floors only

Applicable on:

Aside® Chairs
Caper Chairs

HCC Caster

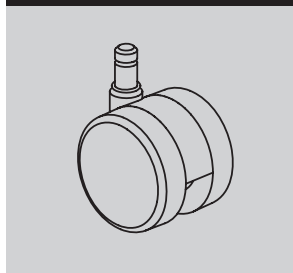

2¹/₂-inch-diameter double-wheel low roll resistance caster; black yoke; for use on hard floors or carpet

Applicable on:

Setu Chairs

O2 Caster



2¹/₂-inch-diameter double-wheel caster; nylon wheels and yoke; soft polyurethane tread; quiet roll technology; for use on hard floors or carpet

Applicable on:

Cosm Chairs

SC8 Caster



2¹/₂-inch-diameter double-wheel caster; black nylon wheels and yoke; soft polyurethane tread; quiet roll technology; for use on hard floors or carpet

Applicable on:

Cosm Chairs
Fuld Nesting Chairs
Lino Chairs
Mirra 2 Chairs
Verus Chairs

Casters and Glides

continued

U4 Caster

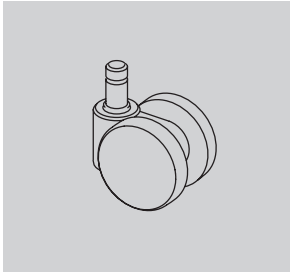

1⁷/₈-inch-diameter hard double-wheel caster; black nylon wheels and yoke; for use on carpet only

Applicable on:

Aside Chairs
Verus Chairs

UD Caster

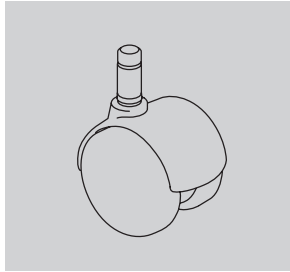

2-inch-diameter hard double-wheel caster; black nylon wheels with painted hood; for use on carpet only

Applicable on:

Eames® Aluminum Group
Eames Executive Chairs
Eames Soft Pad Group
Eames Task Chairs

16 Glide

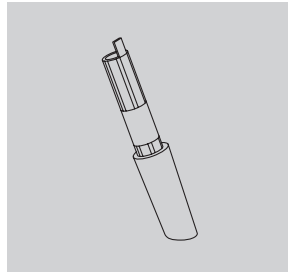

(Front glide shown)

2¹/₈-inch-high glide; black or fog acetal; for use on carpet only

Applicable on:

Sayl Chairs

G4 Glide

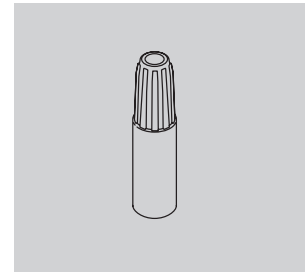

1⁷/₈-inch-high glide; black acetal; for use on carpet only

Applicable on:

Verus Chairs

U5 Caster

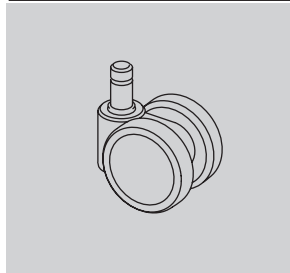

1⁷/₈-inch-diameter soft double-wheel caster; black nylon wheels and yoke; for use on hard floors or carpet

Applicable on:

Aside Chairs
Caper Chairs
Verus Chairs

VD Caster

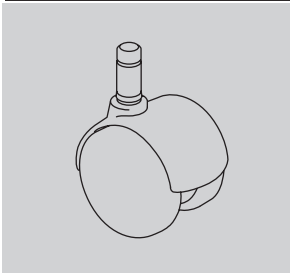

2-inch-diameter hard double-wheel caster; black nylon wheels with integral chrome hood; for use on carpet only

Applicable on:

Eames Aluminum Group
Eames Executive Chairs
Eames Soft Pad Group
Eames Task Chairs

69 Glide

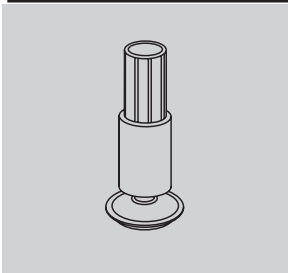

(Front glide shown)

2¹/₈-inch-high glide; black glass-filled nylon stem; steel-plated swivel foot with Floor Saver Glide™ insert; for use on hard floors only

Applicable on:

Sayl Chairs

GD Glide

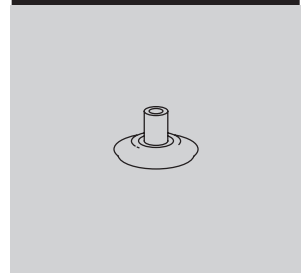

1¹/₂-inch-diameter glide; 1/2 inch in height; black nylon; for use on hard floors or carpet

Applicable on:

Eames Aluminum Group
Eames Executive Chairs
Eames Soft Pad Group
Eames Task Chairs

Casters and Glides

continued

GF Glide

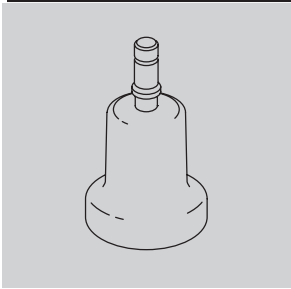

2 1/2-inch-high glide; black nylon; for use on hard floors or carpet

Applicable on:

- New Aeron Chairs
- Caper Chairs
- Cosm Chairs
- Lino Chairs
- Mirra 2 Chairs
- Sayl Chairs
- Verus Chairs

GL Glide

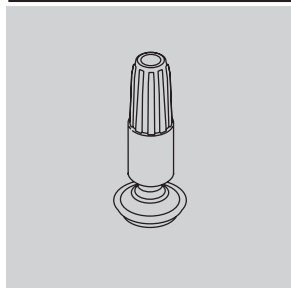

1 7/8-inch-high glide; black nylon stem; steel-plated swivel foot with Floor Saver Glide™ insert; for use on hard floors only

Applicable on:

- Verus chairs

HG Glide

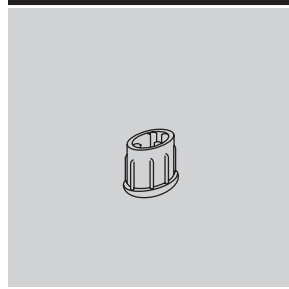

1/2-inch-high glide; black nylon glide with stainless-steel insert; for use on hard floors or carpet

Applicable on:

- Aside Chairs

SG Glide (for Pronta)

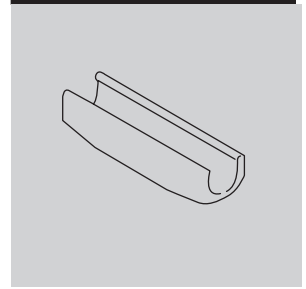

1/2-inch-high glide; clear polycarbonate; for use on hard floors or carpet

Applicable on:

- Pronta Stacking Chairs

GG Glide



1/2-inch-high ganging glide; clear polycarbonate; for use on hard floors or carpet

Applicable on:

- Pronta Stacking Chairs

GLN Glide

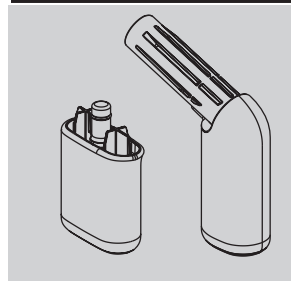

Acetal glide; for use on carpet only

Applicable on:

- Fuld Nesting Chairs

SG Glide (for Aside)

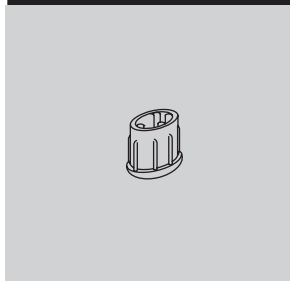

1/2-inch-high glide; black nylon; for use on carpet only

Applicable on:

- Aside Chairs

X8 Glide

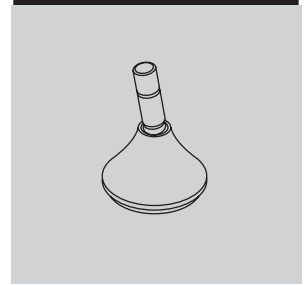

Glide; low profile; for use on hard floors or carpet

Applicable on:

- Setu Chairs

Casters and Glides

continued

XS Glide

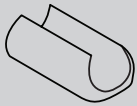

1/8-inch-high glide; polycarbonate in black, fog, clear, and studio white finishes; for use on hard floors or carpet

Applicable on:
Sayl Chairs

YX Glide

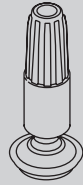

1 7/8-inch-high glide; black nylon stem; steel-plated swivel foot with Floor Saver Glide™ insert; for use on hard floors only

Applicable on:
Caper Chairs

Y7 Glide

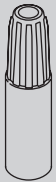

1 7/8-inch-high glide; black acetal; for use on carpet only

Applicable on:
Caper Chairs



Fire Retardancy — Seating

Fire Retardancy

Fire-retardant chairs manufactured in approved fabrics (FR) meet California TB 133 requirements.

All foam and textiles on HermanMiller seating products comply with California TB 117-2013.

State of California
Bureau of Home Furnishings,
Technical Bulletin 133

State of California
Bureau of Home Furnishings,
Technical Bulletin 117-2013

8Z Pellicle		•
Ace		•
AireWeave™ 2		•
Aristo		•
Balance		•
Bento		•
Bingo		•
Crepe		•
Crossing		•
Cygnus™	FR	•
Dex		•
Dialogue		•
Duo		•
Epic		•
Fish Net		•
Flexnet™	FR	•
Gem		•
Hopsak		•
Intercept		•
InterWeave		•
Latitude™		•
Leather		•
Loom		•
Lyris 2™		•
Marvel		•
Medley		•
Mercer		•
Moiré		•
Monologue		•
Noble		•
Pins and Needles		•
Plateau		•
Quilty		•
Rhythm		•
Rivet		•
Sequel		•
Spools		•
Stitches		•
Strata		•
String Plaid		•
Tailored		•
Twist		•
Well Suited		•
Whisper		•

• Fabric meets California TB 117-2013 code requirements.

FR To meet California TB 133 code requirements, fabrics must be applied to approved chairs identified with FR product numbers.



Proprietary Textiles Application Chart — Seating

• Available

[A] Assigned lead-time textile.

[N] Non-woven textile.

See following page for exception notes.

Price Category 1

	Aeron® Chairs	Cosm™ Chairs	Mirra® 2 Chairs/Stools	Embody® Chairs	Fuld Nesting Chairs	Sayl® Work Chairs/Stools	Sayl Side Chairs	Setu® Chairs/Stools	Zeph™ Chairs	Verus™ Work Chairs/Stools Back	Verus Work Chairs/Stools Seat	Verus Side Chairs Back	Verus Side Chairs Seat	Verus Plus Chairs	Aside® Chairs	Caper® Chairs/Stools	Lino™ Chairs Back	Lino Chairs Seat	OE1 Storage Trolley Cushion Top	Public Office Landscape® Back	Public Office Landscape Seat	Plex® Lounge Furniture	Swoop™ Lounge Seating - Fully Upholstered	Swoop Lounge Seating - Plywood	Valor™ Seating	Eames® Tandem Sling Seating	Cushion Tops	Workspaces	
COM Customer's Own Material [A]						1	1			1	1	1	1	1	1			1	1		1	1	1	1	1	1	1	1	1
231__ 8Z Pellicle®	•																												
1A7__ AireWeave™ 2			•																										
8T__ Crossing								•							•				•				•	•			•	•	
3DE__ Dex						•	•	•		•	•	•	•	•	•				•		•	19	•		•		•	•	
4RM__ Duo																	•												
6V__ Flexnet™																•													
95__ Gem								•							•				•			•	•				•	•	
845__ Intercept			•																										
365__ Interweave 2										•		•																	
4W__ Lyris 2™								•																					
1MN__ Monologue						24	22	•		•	•	•						•	•		•	•	•	•	•	•	•	•	
5H2__ Ripple 3D Knit									•																				
5H1__ Splash 3D Knit									•																				
4SC__ Scatter						•	•	•		•	•	•	•	•	•			•	•		•	•	•	•			•	•	
3DN__ Scribe						21	22	•		•		•	•	•	•			•	•		•					•		•	
3DK__ Stretch Knit [A]						21																							
235__ Tailored						•	•	•		•	•	•	•		•			•		•	23				•		7	•	
9NK__ Tuck 3D Knit					•																								
1WS__ Whisper						24	•	•		•	•	•	•	•	•			•	•		•	•	•	•	•	•	•	•	

Price Category 2

3AR__ Aristo						•	•	•		•	•	•	•	•	•			•	•	•	•	•	•	•	•	•	•	•
92__ Crepe						•	•	•		•	•	•	•	•	•			•	•	•	•	•	•	•	•	•	•	•
3EP__ Epic						•	•			•	•	•	•	•	•			•	•	•	•	•	•	•	•	•	•	•
1LM__ Loom						•	•			•	•	•	•	•	•			•	•	•	•	•	•	•	•	•	•	•
1MV__ Marvel [N]						21	22	•										•								•		•
1HA__ Medley				•		•	22			•	•	•	•	•	•			•	•	•	•	•	•	•	•	•	•	•
4ME__ Mellow						•	22	•		•	•	•	•	•	•			•	•	•	•	•	•	•	•	•	•	•
30__ Rhythm					23	•	•			•	•	•	•	•	•			•	•	•	•	•	•	•	•	•	•	•
3SL__ Sequel [N]						•	•	•		•	•	•	•	•	•	8		•	•	•	•	•	•	•	•	•	•	•
4TE__ Terra						•	22			•	•	•	•	•	•			•	•	•	•	•	•	•	•	•	•	•
8R__ Twist						•	•	•		•	•	•	•	•	•			•	•	•	•	•	•	•	•	•	•	•

Price Category 3

3AC__ Ace						21	•			•	•	•	•	•	8			•	•	•	19			•		•		
4LN__ Landing [N]																										•		
8M__ Latitude™					23																							

Price Category 4

3DM__ Daydream						21	•	•		•		•	•	•			•	•		•	•	•			•		•	•
1DL__ Dialogue																				•								
1A9__ Network																				•								
3SY__ Sync				•		•	•	•		•	•	•	•	•	•			•		•	•	•	•	•	•	•	•	•

continued on next page

Proprietary Textiles Application Chart — Seating continued

• Available

[A] Assigned lead-time textile.

[N] Non-woven textile.

See below for exception notes.

	Aeron® Chairs	Cosm™ Chairs	Mirra® 2 Chairs/Stools	Embody® Chairs	Fuld Nesting Chairs	Sayl® Work Chairs/Stools	Sayl Side Chairs	Setu® Chairs/Stools	Zeph™ Chairs	Verus™ Work Chairs/Stools Back	Verus Work Chairs/Stools Seat	Verus Side Chairs Back	Verus Side Chairs Seat	Verus Plus Chairs	Aside® Chairs	Caper® Chairs/Stools	Lino™ Chairs Back	Lino Chairs Seat	OE1 Storage Trolley Cushion Top	Public Office Landscape® Back	Public Office Landscape Seat	Plex® Lounge Furniture	Swoop™ Lounge Seating - Fully Upholstered	Swoop Lounge Seating - Plywood	Valor™ Seating	Eames® Tandem Sling Seating	Cushion Tops	Workspaces
Price Category 5																												
3CY__Cozy						•	•	•		•	•	•	•	•	•			•				•	•	•	•	•	•	•
14A__Hopsak						•	•	•		•	•	•	•	•	•			•	•			•	•	•	•	•	•	•
3SU__Summit [N]						•	•	•		•	•	•	•	•				•				•	•	•	•	•	•	•
Price Category 6																												
35__ Balance				•																								
Price Category 7																												
COL Customer's Own Leather [A]	1														8			1									1	
Price Category 8																												
No fabrics available at this time																												
Price Category 9																												
21__ Leather [N]	23														8		•	•						•			•	

Application Note: Herman Miller cannot guarantee material/pattern alignment in adjacent products. For example, a fabric's pattern may not align from one pedestal cushion top to the next, or from one chair to another.

- 1 Refer to price book appendices and Omni for COM/COL information.
- 7 Available on 1" Cushion Tops only.
- 8 Only available on the Aside nonupholstered outer back option (PB).
- 9 Available on Valor upholstered seat only.
- 19 Available on Plex seat only.
- 21 Not available on Sayl upholstered back work chairs.
- 22 Not available on Sayl side chairs with upholstered backs.
- 23 Available in select colors. Refer to "Proprietary Textile Colors-Seating" for color offering.
- 24 Not available on Sayl upholstered High-Back Work Chairs.

Proprietary Textile Colors — Seating

Price Category 1

Customer's Own Material

See Order Information in Appendices.
Assigned lead-time textile. A

8Z Pellicle®

For New Aeron® Chairs
56% elastomeric
44% polyester

23101 Mineral
23102 Carbon
23103 Graphite

AireWeave™ 2

For Mirra® 2 Chairs
67% elastomeric
33% antimony-free polyester

1A701 Alpine
1A702 Slate Grey
1A703 Graphite
1A704 Lime Green
1A705 Cappuccino
1A706 Urban Orange
1A707 Dark Turquoise
1A708 Twilight

Crossing

54" wide
86% antimony-free polyester
14% polyester

8T03 Wicker
8T04 Porcelain
8T05 Warm Grey
8T10 Tomato
8T13 Green Apple
8T16 Periwinkle
8T17 Cerulean
8T18 Indigo
8T19 Shale
8T22 Tin
8T23 Graphite
8T24 Black

Dex

54" wide
100% recycled polyester

3DE01 Frost
3DE02 Silver Pine
3DE03 Stone
3DE04 Shale
3DE05 Charcoal
3DE06 Gossamer
3DE07 Pine

Duo

For Lino™ Chairs
52% polyester
48% elastomeric

4RM01 Mineral
4RM02 Poppy
4RM03 Green Leaf
4RM04 Jade
4RM05 Shadow
4RM06 Graphite

Flexnet™

For Caper® Chairs
69% elastomeric
31% polyester

6V01 Black
6V02 Silver Grey

Gem

54" wide
100% antimony-free polyester

9502 Tangerine
9503 Red
9507 Twilight
9508 Bayou
9510 Berry Blue
9511 Aqua Green
9512 Green Apple
9514 Black
9515 Slate Grey
9516 Fog

Intercept

For Cosm™ Chairs
60% elastomeric
40% polyester

84501 Graphite
84502 Carbon
84503 Mineral
84504 Nightfall
84505 Glacier
84506 Canyon

Interweave 2

For Verus™ Chairs
65% elastomeric
35% polyester

36501 Iceberg
36502 Poppy
36503 Beachglass
36504 Blue Grotto
36505 Slate
36506 Shale

Lyris 2™

For Setu® Chairs
74% elastomeric
26% polyester

4W21 Alpine
4W22 Mango
4W23 Chartreuse
4W25 Berry Blue
4W26 Slate Grey
4W28 Chino
4W29 Rattan
4W30 Java
4W31 Graphite

Monologue

54" wide
56% recycled polyester
44% polyester

1MN01 Linen
1MN02 Alabaster
1MN03 Truffle
1MN04 Folkstone
1MN05 Silver Pine
1MN06 Slate

Monologue *continued*

1MN07 Seed
1MN08 Yellow Oxide
1MN09 Persimmon
1MN10 Tundra
1MN11 Meadow
1MN12 Blue Sky
1MN13 Blue Spruce
1MN14 Deep Sea

Ripple 3D Knit

Available only on Zeph™ Chairs.
knit to size
51% post-consumer recycled polyester
48% polyester
1% lycra

5H201 Black
5H202 Carbon
5H203 Alpine
5H204 Silt
5H205 Tea Rose
5H206 Cocoa
5H207 Persimmon
5H208 Blaze
5H209 Cayenne
5H210 Falcon
5H211 Mustard Seed
5H212 Patina
5H213 Olive
5H214 Moss
5H215 Aloe
5H216 Glacier
5H217 Ultramarine
5H218 Nightfall
5H219 Bluebell
5H220 Boysenberry
5H221 Nightfall/Bluebell
5H222 Patina/Alpine
5H223 Cayenne/Glacier
5H224 Tea Rose/Olive
5H225 Silt/Blaze

Price category 1 continued on next page

Proprietary Textile Colors — Seating

continued

Price Category 1

continued

Appendix: Proprietary Textile Colors — Seating

Scatter	
54" wide	
100% recycled polyester, with 26% ocean bound plastic	
4SC01	Alpine
4SC02	Fog
4SC03	Shale
4SC04	Persimmon
4SC05	Red Violet
4SC06	Lime Zest
4SC07	Olive
4SC08	Glacier
4SC09	Blue Sky
4SC10	Lagoon
4SC11	Slate Grey
4SC12	Blue Black

Scribe	
54" wide	
100% recycled polyester with 53% ocean bound plastic	
3DN01	Spring Wood
3DN02	Poplar
3DN03	Pewter
3DN04	Deep Sea
3DN05	Fir
3DN06	Nutmeg

Splash 3D Knit	
Available only on Zeph™ Chairs. knit to size	
54% post-consumer recycled polyester 44% polyester 2% lycra	
5H101	Black
5H102	Carbon
5H103	Alpine
5H104	Silt
5H105	Tea Rose
5H106	Cocoa
5H107	Persimmon
5H108	Blaze
5H109	Cayenne
5H110	Falcon

Splash 3D Knit continued	
5H111	Mustard Seed
5H112	Patina
5H113	Olive
5H114	Moss
5H115	Aloe
5H116	Glacier
5H117	Ultramarine
5H118	Nightfall
5H119	Bluebell
5H120	Boysenberry

Stretch Knit	
Assigned lead-time textile. A	
Available only on Sayl® Suspension Back Work Chairs 97% polyester, 3% spandex	

3DK01	Fog
3DK02	Slate Grey
3DK03	Java
3DK04	Black
3DK05	Red
3DK06	Green Apple
3DK07	Berry Blue

Tailored	
54" wide	
56% polyester 44% recycled polyester	
23501	Studio White *
23502	Sugar *
23503	Tomato
23504	Orchid
23505	Boysenberry
23506	Chive
23507	Bluegrass
23508	Cobalt
23509	Cadet
23510	Fog
23511	Graphite
23512	Black
23513	Coffee

* Colors not available on Plex™ Lounge Furniture.

Price Category 2

Aristo	
54" wide	
88% recycled polyester 12% polyester Acrylic backing	
3AR01	Forest Moss
3AR02	Light Brindle
3AR03	Mink
3AR04	Copper
3AR05	Adobe
3AR06	Cherry
3AR07	Lilac
3AR08	Green Apple
3AR09	Surf
3AR10	Waterfall
3AR11	Cadet
3AR12	Tin
3AR13	Pewter
3AR14	Grey Brindle
3AR15	Grey Black

Crepe	
54" wide	
100% recycled polyester, with 43.6% ocean bound plastic	
9201	Licorice
9203	Smoke
9207	Cherry
9223	Cadet
9241	Beachglass
9249	Stone
9251	Fog
9252	Slate Grey
9261	Shale
9262	Graphite
9265	Mineral
9266	Persimmon
9267	Juniper
9268	Glacier
9269	Cascade
9270	Navy

Price category 2 continued on next page

Proprietary Textile Colors — Seating

continued

Price Category 2

continued

Epic	
54" wide	
56% recycled polyester	
44% polyester	
Acrylic backing	
3EP01	Alabaster
3EP02	Smoke
3EP03	Falcon
3EP04	Citrus Spring
3EP05	Copper
3EP06	Urban Orange
3EP07	Poppy
3EP08	Wild Plum
3EP09	Sugar Plum
3EP10	Clover
3EP11	Loden
3EP12	Everglade
3EP13	Mist
3EP14	Peacock
3EP15	Cadet
3EP16	Indigo
3EP17	Spring Wood
3EP18	Grey Brindle
3EP19	Seed
3EP20	Carbon Dark

Loom	
54" wide	
100% polyester	
1LM01	Linen *
1LM03	Brick and Mortar
1LM04	Salt and Pepper
1LM05	Black
1LM08	Wild Berry
1LM09	Loden
1LM10	Jade
1LM11	Deep Sea

* Color not available on Valor™ Seating

Marvel	
54" wide	
100% pvc-free polyurethane	
1MV01	Summer White
1MV02	Sand Dollar
1MV03	Espresso
1MV04	Folkstone Grey
1MV05	Graphite
1MV06	Onyx
1MV07	Polar Blue
1MV08	Blush Grey
1MV09	Woodrose
1MV10	Citrus
1MV11	Adobe
1MV12	Red
1MV13	Kiwi Green
1MV14	Pine
1MV15	Teal Green
1MV16	Twilight

Medley	
54" wide	
100% polyester	
1HA01	Stone
1HA02	Trail
1HA03	Charcoal
1HA04	Cinder
1HA05	Citrus
1HA06	Papaya
1HA07	Chutney
1HA08	Tundra
1HA09	Feather Grey
1HA10	Chartreuse
1HA11	Loden
1HA12	Peacock
1HA13	Bayou
1HA14	Blue Grotto
1HA15	Blueberry
1HA22	Khaki
1HA23	Pewter
1HA24	Yellow Oxide
1HA25	Vintage Rose
1HA26	Raspberry
1HA27	Acai Berry

Mellow	
54" wide	
100% recycled polyester, with 16% ocean bound plastic	
4ME01	Mineral
4ME02	Pewter
4ME03	Wisteria
4ME04	Olive
4ME05	Glacier
4ME06	Oceanside
4ME07	Charcoal

Rhythm	
54" wide	
100% polyester	
3001	Kiwi Green *
3002	Green Apple *
3003	Peacock *
3004	Bayou *
3005	Berry Blue
3006	Iris *
3007	Twilight
3008	Pumpkin *
3009	Poppy *
3010	Molasses *
3011	Mulberry *
3012	Khaki *
3013	Mink *
3014	Black
3015	Charcoal

* Colors not available on Embody® Chair.

Sequel	
54" wide	
100% vinyl	
100% polyester knit backing	
Resilience® finish	
3SL01	White
3SL02	Pebble
3SL03	Mushroom
3SL04	Stone
3SL05	Chestnut
3SL06	Rattan
3SL07	Black Cherry
3SL08	Tundra
3SL09	Seal
3SL10	Blue Fog
3SL11	Folkstone
3SL12	Shale
3SL13	Slate Grey
3SL14	Charcoal
3SL15	Carbon Dark
3SL28	Navy *

* Color available on Eames® Tandem Sling Seating.

Terra	
54" wide	
100% post-consumer recycled biodegradable polyester *	
4TE01	Spring Wood
4TE02	Zinc
4TE03	Pine Cone
4TE04	Charcoal

* 1% biodegradation in 1,278 days under ASTM D5511 conditions. No evidence of further degradation.

Price category 2 continued on next page

Proprietary Textile Colors — Seating

continued

Price Category 2

continued

Twist	
54" wide	
80% antimony-free polyester	
13% recycled polyester	
7% polyester	
8R05	Wicker
8R10	Poppy
8R14	Tin
8R15	Shale
8R16	Graphite
8R17	Birch
8R18	Sepia
8R22	Blueberry
8R23	Green Apple
8R26	Gunmetal
8R27	Cinder
8R28	Citrus
8R29	Pekoe
8R30	Tangerine
8R31	Red Plum
8R32	Wisteria
8R33	Forest
8R34	Jade Dark
8R35	Waterfall
8R36	Midnight Blue
8R37	Carbon Dark

Price Category 3

Ace	
54" wide	
100% polyurethane	
Polyester knit backing	
Stain resistant finish	
3AC01	Summer White
3AC02	White Ash
3AC03	Rye
3AC04	Metal
3AC05	Clay
3AC06	Chestnut
3AC07	Citrus
3AC08	Camelback
3AC09	Chipotle
3AC10	Claret
3AC11	Slate Purple
3AC12	Artichoke
3AC13	Sepia Dark
3AC14	Aloe
3AC15	Flint
3AC16	Blue Sky
3AC17	Oceanside
3AC18	Midnight
3AC19	Spring Wood
3AC20	Frost
3AC21	Lead
3AC22	Black

Landing	
For Eames® Tandem Sling Seating	
54" wide	
100% TPE	
Polyester knit backing	
4LN01	Black

Latitude™	
61" wide	
100% polyester	
8M01	Graphite
8M02	Shadow
8M10	Alpine
8M17	Black
8M21	Slate Grey
8M22	Lime Green
8M23	French Press
8M24	Urban Orange
8M25	Dark Turquoise
8M26	Twilight

Latitude	
Colors for Mirra 2 Chairs	
100% polyester	
8M10	Alpine
8M17	Black
8M21	Slate Grey
8M22	Lime Green
8M23	French Press
8M24	Urban Orange
8M25	Dark Turquoise
8M26	Twilight

Price Category 4

Daydream	
54" wide	
48% wool	
41% recycled polyester	
9% nylon	
2% polyester	
3DM01	Rye Grass
3DM02	Silver Birch
3DM03	Pewter
3DM04	Graphite
3DM05	Black
3DM06	Lemongrass
3DM07	Permission
3DM08	Juniper
3DM09	Sea Grass
3DM10	Nightfall

Dialogue	
For Public Office Landscape®	
Sectional Back/Social Chair Back	
knit to size	
100% polyester	
1DL01	Light Brindle
1DL02	Dark Brindle

Network	
For Public Office Landscape®	
Sectional Back/Social Chair Back	
knit to size	
100% polyester	
1A901	Warm White
1A902	Fog
1A903	Red
1A904	Wildberry
1A905	Green Apple
1A906	Twilight
1A907	Graphite

Price category 4 continued on next page

Proprietary Textile Colors — Seating

continued

Price Category 4

continued

Sync	
55" wide	
100% polyester	
3SY01	Pine Cone
3SY02	Citron
3SY03	Canyon
3SY04	Truffle
3SY05	Wild Berry
3SY06	Everglade
3SY07	Glacier
3SY08	Nightfall
3SY09	Dark Mineral
3SY10	Slate Grey
3SY11	Dark Carbon
3SY12	Black

Price Category 5

Cozy	
54" wide	
100% wool	
3CY01	Heathered Warm Grey
3CY02	Heathered Rye Grass
3CY03	Heathered Cool Grey
3CY04	Heathered Blue Grey
3CY05	Heathered Black
3CY06	Heathered Persimmon
3CY07	Heathered Loden
3CY08	Heathered Jade
3CY09	Heathered Lagoon
3CY10	Heathered Twilight

Hopsak	
56" wide	
100% recycled polyester	
14A20	Black
14A22	Raw Umber Dark
14A26	Grey Blue Dark
14A30	Sepia Dark
14A38	Emerald Dark
14A39	Yellow Dark
14A40	Orange
14A41	Sienna
14A42	Olive Green Dark
14A43	Crimson
14A44	Crimson Dark Dark
14A45	Violet Dark
14A46	Pink Dark Dark
14A47	Ultramarine Dark
14A48	Cobalt Blue
14A49	Terra Cotta
14A50	Ochre Dark

Summit	
54" wide	
100% silicone	
Polyester knit backing	
3SU01	Bright White
3SU02	Oyster
3SU03	Zinc
3SU04	Sparrow
3SU05	Taupe
3SU06	Java
3SU07	Black
3SU08	Cherry
3SU09	Beachglass
3SU10	Midnight

Price Category 6

Balance	
For Embody® chairs	
100% polyester	
3512	Carbon
3513	Black

Appendix: Proprietary Textile Colors — Seating

Proprietary Textile Colors — Seating

continued

Price Category 7

Customer's Own Leather
See Order Information in Appendices. Assigned lead-time textile. [A](#)

Price Category 8

No fabrics available at this time.

Price Category 9

Leather	
approx. 50 sq. ft. per hide	
100% leather	
2101	Ivory
2109	Black *
2110	Smoke
2111	Graphite
2112	Khaki
2113	Rattan
2114	Truffle
2115	Alpine
2116	Haze
2117	Sable Grey
2118	Dark Mineral **
2119	Dark Carbon ***
2120	Cranberry
2121	Deep Sea

* Armpad color available on Aeron® Chair, Graphite.

** Armpad color available on Aeron Chair, Mineral.

*** Armpad color available on Aeron Chair, Carbon.

Maharam® Application Chart — Seating

- Available

[A] Maharam textiles are on assigned lead times.

[N] Non-woven textile.

See below for exception notes.

	Asari Work Chairs by Herman Miller™	Sayl® Work Chairs/Stools	Sayl Side Chairs	Setu® Chairs/Stools	Verus® Work Chairs/Stools Back	Verus Work Chairs/Stools Seat	Verus Side Chairs Back	Verus Side Chairs Seat	Verus Plus Chairs	Aside® Chairs	Caper® Chairs/Stools	Lino® Chairs Seat	OE1 Storage Trolley Cushion Top	Public Office Landscape® Seat	Plex® Lounge Furniture	Swoop™ Lounge Seating - Fully Upholstered	Swoop Lounge Seating - Plywood	Valor™ Seating	Cushion Tops	Workspaces
Price Category 1																				
No fabrics available at this time.																				
Price Category 2																				
ZMA__ Metaphor - Maharam		16	16	•	•	•	•	•	•	•	•	•	•	•	•	•	•	•	•	•
811__ Muse - Maharam		16	16		•	•					•		•				26			•
Price Category 3																				
ZM2__ Meld - Maharam *		•	•	•	•	•	•	•	•	8	•	•	•	•	•	•			•	•
Price Category 4																				
ZLR__ Lariat - Maharam [N]		•	•	•	•	•	•	•	•				•	•	20				•	•
Price Category 5																				
4OG__ Method - Maharam		16	16	•	•	•	•	•	•		•	•	•	•	•	•			•	•
ZNC__ Nico - Maharam		•	•		•	•	•	•	•		•		•	•	•	•	•	•	•	•
Price Category 6																				
No fabrics available at this time.																				
Price Category 7																				
ZB3__ Beck - Maharam		16	16	•	•	•	•	•	•		•		•	•	•	•	•	•	•	•
Price Category 8																				
ZLU__ Luce - Maharam		•	16	16	•	•	•	•	•		•		•	•	•	•	•	•	•	•
Price Category 9																				
ZC0__ Campana - Maharam		16	16		•	•	•	•	•		•		•	•	•	•	•	•	•	•
ZGE__ Gemma - Maharam		•	•	•	•	•	•	•	•		•		•	•	•	•	•	•	•	•
ZJA__ Jasper - Maharam		16	16		•	•	•	•	•		•		•						•	7
Price Category 10																				
3KH__ Firma - Maharam		16		•	•	•	•	•	•		•		•	•	•	•	•	•	•	•
ZGF__ Gemma Multi - Maharam		•	•	•	•	•	•	•	•		•		•	•	•	•	•	•	•	•
ZGF__ Gemma Multi Reverse - Maharam		•	•	•	•	•	•	•	•		•		•	•	•	•	•	•	•	•
ZP4__ Petra - Maharam		16	16		•	•	•	•	•		•		•	•	•	•	•	•	•	•
Price Category A																				
No fabrics available at this time.																				
Price Category B																				
VM__ Medium - Maharam		•	•		•	•		•	•	•	•	•							•	•
TI__ Messenger - Maharam *		•	•	•	•	•	•	•	•		•		•	•				26		•
Price Category C																				
Z27__ Manner - Maharam		•	•		•	•		•	•	•	•	•							•	•
887__ Merit - Maharam		•	•		•	•	•	•	•		•		•	•	•	•	•	•	•	•
Z3__ Metric - Maharam		•	•		•	•	•	•	•		•		•	•	•	•	•	•	•	•
ZML__ Milestone - Maharam		•	•		•	•		•	•		•		•	•	•	•	•	•	•	•
8EY__ Murmur - Maharam		•	16		•	•		•	•		•		•	•	•	•	•	•	•	7
Price Category D																				
818__ Bluff - Maharam [N]		16	16		•	•	•	•	•	8			•	21		•	•	•	•	
ZMD__ Mode - Maharam		18	•	•	•	•	•	•	•			•		•	•	•	•	•	•	•

continued on next page

* Available in select colors on 20-day lead-time. Refer to "Maharam Colors - Seating" for 20-day colors.

Maharam® Application Chart — Seating *continued*

• Available

[A] Maharam textiles are on assigned lead times.

[N] Non-woven textile.

See below for exception notes.

Appendix: Maharam Application Chart — Seating

	Asari Work Chairs by Herman Miller™	Sayl® Work Chairs/Stools	Sayl Side Chairs	Setu® Chairs/Stools	Verus® Work Chairs/Stools Back	Verus Work Chairs/Stools Seat	Verus Side Chairs Back	Verus Side Chairs Seat	Verus Plus Chairs	Aside® Chairs	Caper® Chairs/Stools	Lino® Chairs Seat	OE1 Storage Trolley Cushion Top	Public Office Landscape® Seat	Plex® Lounge Furniture	Swoop™ Lounge Seating - Fully Upholstered	Swoop Lounge Seating - Plywood	Valor™ Seating	Cushion Tops	Workspaces
Price Category E																				
ZAT__ Article - Maharam [N]		16	16		•	•	•	•				•	•					•	7	
ZR2__ Roster - Maharam		16	16			•		•	•			•		•			•			•
Price Category F																				
82T__ Apt - Maharam [N]		18	•			•	•						•			•		•	7	
871__ Brindle - Maharam		16	16			•	•			•		•	•					•	•	
87Z__ Conduit - Maharam		16	16		•	•	•	•		•		•		•					7	
74M__ Instill - Maharam [N]		18	16		•	•	•	•				•		•	•		•	•	7	
89N__ Keen - Maharam		16	16			•	•	•	•			•		•	•	•	•			
V9G__ Ledger - Maharam [N]		18	16		•	•		•	•			•	•					•	•	
ZLL__ Loop - Maharam		16	16			•		•		8		•		•					•	
82A__ Multiply - Maharam		16	16		•	•	•	•		•		•		•			•	•	•	
8LW__ Pepper - Maharam		16	16			•		•		•		•		•	21		•		9	•
Z31__ Sequence - Maharam		•	•		•	•	•	•		•		•				•		•	•	
Z33__ Strum - Maharam [N]			16													•		•	7	
Price Category G																				
ZC2__ Compound - Maharam [N]		16	16		•	•	•	•		8		•			•		•	•	7	
ZF1__ Fold - Maharam [N]		16	16																•	7
8AR__ Gild - Maharam			16		•	•	•	•						•	21		•	•		
ZPR__ Pare - Maharam		18	16			•		•		8		•		•	•	•		•	7	
ZP1__ Pick Crypton - Maharam		16	•		•	•		•		•		•							•	7
ZRF__ Runner - Maharam		16	16										•						•	•
Price Category H																				
ZT__ Circles - Maharam		16	16																	•
ZK__ Dot Pattern - Maharam		•	•	•		•		•		•		•							•	•
ZQF__ Offset - Maharam		16	•							•		•							•	
ZL__ Small Dot Pattern - Maharam		•	•	•		•		•		•		•							•	•
Price Category I																				
7CW__ Cursive - Maharam		16	16		•	•	•	•		8		•	•	•		•		•	•	
ZSY__ Study - Maharam													•						•	

continued on next page

Maharam® Application Chart — Seating *continued*

• Available

[A] Maharam textiles are on assigned lead times.

[N] Non-woven textile.

See below for exception notes.

	Asari Work Chairs by Herman Miller™	Sayl® Work Chairs/Stools	Sayl Side Chairs	Setu® Chairs/Stools	Verus® Work Chairs/Stools Back	Verus Work Chairs/Stools Seat	Verus Side Chairs Back	Verus Side Chairs Seat	Verus Plus Chairs	Aside® Chairs	Caper® Chairs/Stools	Lino® Chairs Seat	OE1 Storage Trolley Cushion Top	Public Office Landscape® Seat	Plex® Lounge Furniture	Swoop™ Lounge Seating - Fully Upholstered	Swoop Lounge Seating - Plywood	Valor™ Seating	Cushion Tops	Workspaces
Price Category J-K	No fabrics available at this time.																			
Price Category L	ZMK_ _ Minicheck - Maharam																			
		•	•			•	•	•		•		•						•		7
Price Category M	ZF2_ _ Fruit - Maharam																			
				16						•										7
Price Category N-Q	No fabrics available at this time.																			
Price Category R	Stow Leather																			
	•																			
Price Category S-Z	No fabrics available at this time.																			

7 Available on 1” Cushion Tops only.

8 Only available on the Aside nonupholstered outer back option (PB).

9 Available on Valor upholstered seat.

16 Available on Sayl Chair seat.

18 Available on Sayl Chair seat and upholstered mid-back.

20 Not available on Plex Club Chair with Headrest.

21 Available on Plex seat and on Ottoman.

26 Available in select colors. Refer to “Maharam Textile Colors - Seating” for color offering.



Maharam® Colors — Seating

Price Category 1

No fabrics available at this time.

Price Category 2

Metaphor – Maharam	
54" wide	
100% polyester	
Acrylic backing	
ZMA01/466553-001 Afterfeather	
ZMA02/466553-002 Moonflower	
ZMA03/466553-003 Handcraft	
ZMA04/466553-004 Crossroad	
ZMA05/466553-005 Chondrite	
ZMA06/466553-006 Detective	
ZMA07/466553-007 Steamship	
ZMA08/466553-008 Electricity	
ZMA09/466553-009 Takeoff	
ZMA10/466553-010 Parachute	
ZMA11/466553-011 Blueshift	
ZMA12/466553-012 Dockyard	
ZMA13/466553-013 Bathe	
ZMA14/466553-014 Icebound	
ZMA15/466553-015 Thermosphere	
ZMA16/466553-016 Aboard	
ZMA17/466553-017 Agateway	
ZMA18/466553-018 Homeland	
ZMA19/466553-019 Rockfall	
ZMA20/466553-020 Undergrowth	
ZMA21/466553-021 Gremolata	
ZMA22/466553-022 Patina	
ZMA23/466553-023 Sylvan	
ZMA24/466553-024 Outfield	
ZMA25/466553-025 Windbreak	
ZMA26/466553-026 Saguaro	
ZMA27/466553-027 Barnwood	
ZMA28/466553-028 Cookshop	
ZMA29/466553-029 Amandine	
ZMA30/466553-030 Bodhran	
ZMA31/466553-031 Centerstage	
ZMA32/466553-032 Focaccia	
ZMA33/466553-033 Bumblebee	
ZMA34/466553-034 Microbrew	
ZMA35/466553-035 Sauna	
ZMA36/466553-036 Gazebo	
ZMA37/466553-037 Pirouette	
ZMA38/466553-038 Heartbeat	
ZMA39/466553-039 Shino	
ZMA40/466553-040 Sunrise	
ZMA41/466553-041 Florist	

Metaphor <i>continued</i>	
ZMA42/466553-042 Beadwork	
ZMA43/466553-043 Framboise	
ZMA44/466553-044 Wisteria	
ZMA45/466553-045 Warrior	

Muse – Maharam	
54" wide	
100% post-consumer recycled polyester	
81101/466487-001 Crescendo	
81102/466487-002 Resonate	
81103/466487-003 Runway	
81104/466487-004 Ascend	
81105/466487-005 Veil *	
81106/466487-006 Refresh *	
81107/466487-007 Clear *	
81108/466487-008 Fantasy	
81109/466487-009 Miso	
81110/466487-010 Compass	
81111/466487-011 Bergamot *	
81112/466487-012 Grasshopper	
81113/466487-013 Goal	
81114/466487-014 Mistletoe	
81115/466487-015 Seaglass *	
81116/466487-016 Frigid	
81117/466487-017 Riverbend	
81118/466487-018 Noble	
81119/466487-019 Pulsar	
81120/466487-020 Velella	
81121/466487-021 Sailboat	
81122/466487-022 Sparse	
81123/466487-023 Vase	
81124/466487-024 Haven	
81125/466487-025 Mead	
81126/466487-026 Neat	
81127/466487-027 Jovial	
81128/466487-028 Theater	
81129/466487-029 Poinsettia	
81130/466487-030 Celebrate	
81131/466487-031 Spectacle	

* Colors not available on Valor Seating.

Price Category 3

Meld – Maharam	
54" wide	
68% post-consumer recycled polyester	
32% polyester	
PFOA-Free stain resistant	
ZM201/466387-201 Vast	
ZM202/466387-202 Panda **	
ZM203/466387-203 Skyline *	
ZM204/466387-204 Knight **	
ZM205/466387-205 Quill **	
ZM206/466387-206 Pipe	
ZM207/466387-207 Grate *	
ZM208/466387-208 Gloss	
ZM209/466387-209 Bulb	
ZM210/466387-210 Bride	
ZM211/466387-211 Stark	
ZM212/466387-212 Seashell	
ZM213/466387-213 Antler	
ZM214/466387-214 Crater *	
ZM215/466387-215 Perennial	
ZM216/466387-216 Mulberry	
ZM217/466387-217 Fuchsia *	
ZM218/466387-218 Amethyst *	
ZM219/466387-219 Merlot	
ZM220/466387-220 Magma *	
ZM221/466387-221 Rooster	
ZM222/466387-222 Heat *	
ZM223/466387-223 Clementine	
ZM224/466387-224 Fox	
ZM225/466387-225 Kiss *	
ZM226/466387-226 Bare	
ZM227/466387-227 Blonde	
ZM228/466387-228 Mimosa	
ZM229/466387-229 Comet *	
ZM230/466387-230 Honeydew	
ZM231/466387-231 Wild *	
ZM232/466387-232 Vine	
ZM233/466387-233 Seed	
ZM234/466387-234 Kale *	

* Colors available on 20-day lead time.

** Colors available on 10-day lead time.

Price category 3 continued on next page

- Maharam textiles are on assigned lead times A unless otherwise noted.
- Fabric numbers are listed as Herman Miller fabric number/Maharam fabric number.

Maharam® Colors — Seating

continued

Price Category 3

continued

Meld continued	
ZM235/466387-235	Waterfall *
ZM236/466387-236	Nordic *
ZM237/466387-237	Reef *
ZM238/466387-238	Wave
ZM239/466387-239	Isle **
ZM240/466387-240	Creek
ZM241/466387-241	Mariner *
ZM242/466387-242	Globe
ZM243/466387-243	Spa

* Colors available on
20-day lead time.

** Colors available on
10-day lead time.

Price Category 4

Lariat – Maharam	
54" wide	
100% vinyl	
ZLR01/440401-001	001
ZLR02/440401-002	002
ZLR03/440401-003	003
ZLR04/440401-004	004
ZLR06/440401-006	006
ZLR07/440401-007	007
ZLR08/440401-008	008
ZLR10/440401-010	010
ZLR11/440401-011	011
ZLR12/440401-012	012
ZLR13/440401-013	013
ZLR14/440401-014	014
ZLR15/440401-015	015
ZLR16/440401-016	016
ZLR18/440401-018	018
ZLR20/440401-020	020
ZLR21/440401-021	021
ZLR23/440401-023	023
ZLR24/440401-024	024
ZLR25/440401-025	025
ZLR26/440401-026	026
ZLR27/440401-027	027

Lariat continued	
ZLR28/440401-028	028
ZLR29/440401-029	029
ZLR30/440401-030	030
ZLR31/440401-031	031
ZLR32/440401-032	032
ZLR33/440401-033	033
ZLR34/440401-034	034
ZLR36/440401-036	036
ZLR37/440401-037	037
ZLR38/440401-038	038
ZLR39/440401-039	Granite
ZLR40/440401-040	Linen
ZLR41/440401-041	Stella
ZLR42/440401-042	Saddle
ZLR43/440401-043	Holly
ZLR44/440401-044	Maroon
ZLR45/440401-045	Siren
ZLR46/440401-046	Reseda
ZLR47/440401-047	Purslane
ZLR48/440401-048	Spire
ZLR49/440401-049	Papyrus
ZLR50/440401-050	Chickadee
ZLR51/440401-051	Requiem

Price Category 5

Method - Maharam	
54" wide	
100% recycled polyester with 9% ocean-bound plastic	
40G01/466579-001	Inspire
40G02/466579-002	Rhea
40G03/466579-003	Noise
40G04/466579-004	Speedway
40G05/466579-005	Villanelle
40G06/466579-006	Maestro
40G07/466579-007	Destiny
40G08/466579-008	Possess
40G09/466579-009	Waterside
40G10/466579-010	Relax
40G11/466579-011	Delightful
40G12/466579-012	Parrotlet
40G13/466579-013	Verdurous
40G14/466579-014	Bosky
40G15/466579-015	Acreage
40G16/466579-016	Allude
40G17/466579-017	Tweed
40G18/466579-018	Korma
40G19/466579-019	Fossilize
40G20/466579-020	Cattail
40G21/466579-021	Shortcake
40G22/466579-022	Racecar
40G23/466579-023	Courtship
40G24/466579-024	Jam
40G25/466579-025	Sparrow

Price category 5 continued on
next page

- Maharam textiles are on assigned lead times **A** unless otherwise noted.
- Fabric numbers are listed as Herman Miller fabric number/Maharam fabric number.

Maharam® Colors — Seating

continued

Price Category 5

continued

Nico - Maharam	
54" wide	
63% wool	
21% polyester	
16% solution-dyed nylon	
ZNC01/466564-001	Alcazar
ZNC02/466564-002	Ironclad
ZNC03/466564-003	Tune
ZNC04/466564-004	Bridegroom
ZNC05/466564-005	Diode
ZNC06/466564-006	Jest
ZNC07/466564-007	Sanctuary
ZNC08/466564-008	Aquarius
ZNC09/466564-009	Houseboat
ZNC10/466564-010	Olympian
ZNC11/466564-011	Tennis
ZNC12/466564-012	Dressage
ZNC13/466564-013	Zing
ZNC14/466564-014	Bitterroot
ZNC15/466564-015	Gemini
ZNC16/466564-016	Posh
ZNC17/466564-017	Sizzle
ZNC18/466564-018	Cheerful
ZNC19/466564-019	Watermelon
ZNC20/466564-020	Toucan
ZNC21/466564-021	Rosin
ZNC22/466564-022	Jousting
ZNC23/466564-023	Jobja
ZNC24/466564-024	Dromedary
ZNC25/466564-025	Toasty
ZNC26/466564-026	Casaba
ZNC27/466564-027	Greenhouse
ZNC28/466564-028	Sibyl
ZNC29/466564-029	Spearmint
ZNC30/466564-030	Pothos
ZNC31/466564-031	Calathea
ZNC32/466564-032	Landscape
ZNC33/466564-033	Espalier
ZNC34/466564-034	Gecko
ZNC35/466564-035	Meditation

Price Category 6

No fabrics available at this time.

Price Category 7

Beck - Maharam	
55" wide	
78% wool	
22% nylon	
ZB301/466571-001	Overshadow
ZB302/466571-002	Molecule
ZB303/466571-003	Zeitgeist
ZB304/466571-004	Blacksmith
ZB305/466571-005	Cornerstone
ZB306/466571-006	Chainmail
ZB307/466571-007	Buckram
ZB308/466571-008	Callisto
ZB309/466571-009	Interlude
ZB310/466571-010	Letterpress
ZB311/466571-011	Memoir
ZB312/466571-012	Litmus
ZB313/466571-013	Stoic
ZB314/466571-014	Inkpad
ZB315/466571-015	Praxis
ZB316/466571-016	Astute
ZB317/466571-017	Percolate
ZB318/466571-018	Halocline
ZB319/466571-019	Semblance
ZB320/466571-020	Loch
ZB321/466571-021	Lido
ZB322/466571-022	Underwater
ZB323/466571-023	Tetrapod

Beck <i>continued</i>	
ZB324/466571-024	Nymph
ZB325/466571-025	Appalachian
ZB326/466571-026	Menthol
ZB327/466571-027	Woodruff
ZB328/466571-028	Malachite
ZB329/466571-029	Botanist
ZB330/466571-030	Woodlet
ZB331/466571-031	Katydid
ZB332/466571-032	Exuberant
ZB333/466571-033	Retrospect
ZB334/466571-034	Lambic
ZB335/466571-035	Argil
ZB336/466571-036	Brushstroke
ZB337/466571-037	Candescent
ZB338/466571-038	Reedbuck
ZB339/466571-039	Clayware
ZB340/466571-040	Curio
ZB341/466571-041	Whimsy
ZB342/466571-042	Effervescent
ZB343/466571-043	Lingonberry
ZB344/466571-044	Resplendent
ZB345/466571-045	Hollyhock
ZB346/466571-046	Filigree
ZB347/466571-047	Plutonic
ZB348/466571-048	Foundry
ZB349/466571-049	Patisserie

Appendix: Maharam Colors — Seating

- Maharam textiles are on assigned lead times A unless otherwise noted.
- Fabric numbers are listed as Herman Miller fabric number/Maharam fabric number.

Maharam® Colors — Seating

continued

Price Category 8

Luce - Maharam
59" wide
75% post-consumer recycled wool
20% polyester
5% nylon
ZLU01/466566-001 Brioche
ZLU02/466566-002 Blanched
ZLU03/466566-003 Relic
ZLU04/466566-004 Sinter
ZLU05/466566-005 Scoria
ZLU06/466566-006 Austere
ZLU07/466566-007 Pigment
ZLU08/466566-008 Alkali
ZLU09/466566-009 Tidal
ZLU10/466566-010 Imbue
ZLU11/466566-011 Reservoir
ZLU12/466566-012 Brine
ZLU13/466566-013 Undertone
ZLU14/466566-014 Prelude
ZLU15/466566-015 Submerge
ZLU16/466566-016 Cypress
ZLU17/466566-017 Awash
ZLU18/466566-018 Adriatic
ZLU19/466566-019 Province
ZLU20/466566-020 Virescent
ZLU21/466566-021 Nettle
ZLU22/466566-022 Agrarian
ZLU23/466566-023 Serpentine
ZLU24/466566-024 Laurel
ZLU25/466566-025 Clarion
ZLU26/466566-026 Gooseberry
ZLU27/466566-027 Swelter
ZLU28/466566-028 Etruscan
ZLU29/466566-029 Coulis
ZLU30/466566-030 Rubescent
ZLU31/466566-031 Akoya
ZLU32/466566-032 Radiant
ZLU33/466566-033 Regent
ZLU34/466566-034 Spectral
ZLU35/466566-035 Thistle

Price Category 9

Campana – Maharam
59" wide
85% wool
15% nylon
ZC001/466571-001 Viverine
ZC002/466571-002 Lithograph
ZC003/466571-003 Moonscape
ZC004/466571-004 Brevity
ZC005/466571-005 Linear
ZC006/466571-006 Hinterland
ZC007/466571-007 Mural
ZC008/466571-008 Sloe
ZC009/466571-009 Interstellar
ZC010/466571-010 Mythology
ZC011/466571-011 Scintillate
ZC012/466571-012 Succession
ZC013/466571-013 Visceral
ZC014/466571-014 Hemisphere
ZC015/466571-015 Troposphere
ZC016/466571-016 Skye
ZC017/466571-017 Seaward
ZC018/466571-018 Nemorous
ZC019/466571-019 Allegory
ZC020/466571-020 Olivine
ZC021/466571-021 Reptilian
ZC022/466571-022 Basil
ZC023/466571-023 Fanleaf
ZC024/466571-024 Beachgrass
ZC025/466571-025 Hayfield
ZC026/466571-026 Freesia
ZC027/466571-027 Rhodium
ZC028/466571-028 Undercoat
ZC029/466571-029 Airbrush
ZC030/466571-030 Shellfish
ZC031/466571-031 Mojave
ZC032/466571-032 Renaissance
ZC033/466571-033 Decoupage
ZC034/466571-034 Outback
ZC035/466571-035 Millipede

Gemma – Maharam
55" wide
85% wool
15% nylon
ZGE01/466568-001 Crinoline
ZGE02/466568-002 Angelic
ZGE03/466568-003 Savory
ZGE04/466568-004 Honeycomb
ZGE05/466568-005 Gilded
ZGE06/466568-006 Paddleboat
ZGE07/466568-007 Stagecoach
ZGE08/466568-008 Waterbuck
ZGE09/466568-009 Earnest
ZGE10/466568-010 Auric
ZGE11/466568-011 Carmine
ZGE12/466568-012 Serape
ZGE13/466568-013 Ferric
ZGE14/466568-014 Canyon
ZGE15/466568-015 Alembic
ZGE16/466568-016 Patio
ZGE17/466568-017 Sorrel
ZGE18/466568-018 Root
ZGE19/466568-019 Mansion
ZGE20/466568-020 Buff
ZGE21/466568-021 Starch
ZGE22/466568-022 Dawn
ZGE23/466568-023 Countryside
ZGE24/466568-024 Dewy
ZGE25/466568-025 Reliquary
ZGE26/466568-026 Deluge
ZGE27/466568-027 Overlay
ZGE28/466568-028 Electron
ZGE29/466568-029 Sheath
ZGE30/466568-030 Quietude
ZGE31/466568-031 Jargon
ZGE32/466568-032 Powder
ZGE33/466568-033 Tide
ZGE34/466568-034 Outwash
ZGE35/466568-035 Enamored
ZGE36/466568-036 Smitten
ZGE37/466568-037 Revere
ZGE38/466568-038 Mangosteen
ZGE39/466568-039 Allium
ZGE40/466568-040 Immense
ZGE41/466568-041 Chamber

Gemma continued
ZGE42/466568-042 Cosmos
ZGE43/466568-043 Inklings
ZGE44/466568-044 Rainwater
ZGE45/466568-045 Shade
ZGE46/466568-046 Pendant
ZGE47/466568-047 Axial
ZGE48/466568-048 Fervent
ZGE49/466568-049 Legacy
ZGE50/466568-050 Caliber
ZGE51/466568-051 Temple
ZGE52/466568-052 Evenfall

Jasper - Maharam
53" wide
55% wool
27% solution-dyed nylon
18% cotton
ZJA01/466563-001 Thrill
ZJA02/466563-002 Anise
ZJA03/466563-003 Grapefruit
ZJA04/466563-004 Lifeguard
ZJA05/466563-005 Heartfelt
ZJA06/466563-006 Corsage
ZJA07/466563-007 Earthenware
ZJA08/466563-008 Bear
ZJA09/466563-009 Firelight
ZJA10/466563-010 Dreamcatcher
ZJA11/466563-011 Bobcat
ZJA12/466563-012 Glacial
ZJA13/466563-013 Vaporize
ZJA14/466563-014 Trapdoor
ZJA15/466563-015 Halcyon
ZJA16/466563-016 Observatory
ZJA17/466563-017 Steamboat
ZJA18/466563-018 Aquathlon
ZJA19/466563-019 Cloudless
ZJA20/466563-020 Briny
ZJA21/466563-021 Magical
ZJA22/466563-022 Picnic
ZJA23/466563-023 Herbage
ZJA24/466563-024 Pasture
ZJA25/466563-025 Courtyard
ZJA26/466563-026 Leapfrog

- Maharam textiles are on assigned lead times A unless otherwise noted.
- Fabric numbers are listed as Herman Miller fabric number/Maharam fabric number.

Maharam® Colors – Seating

continued

Price Category 10

Firma – Maharam

55" wide
78% wool
22% nylon
3KH01/466582-001 Wrath
3KH02/466582-002 Pantomime
3KH03/466582-003 Shaded
3KH04/466582-004 Prologue
3KH05/466582-005 Framework
3KH06/466582-006 Railroad
3KH07/466582-007 Grommet
3KH08/466582-008 Lunisolar
3KH09/466582-009 Snowpack
3KH10/466582-010 Coldsnap
3KH11/466582-011 Sealift
3KH12/466582-012 Brood
3KH13/466582-013 Intertidal
3KH14/466582-014 Confide
3KH15/466582-015 Secluded
3KH16/466582-016 Leisure
3KH17/466582-017 Portfolio
3KH18/466582-018 Strato
3KH19/466582-019 Fogbow
3KH20/466582-020 Snowcone
3KH21/466582-021 Kazoo
3KH22/466582-022 Esteem
3KH23/466582-023 Mackerel
3KH24/466582-024 Brooch
3KH25/466582-025 Caesious
3KH26/466582-026 Islet
3KH27/466582-027 Biosphere
3KH28/466582-028 Hilltop
3KH29/466582-029 Arboreal
3KH30/466582-030 Lineage
3KH31/466582-031 Comfrey
3KH32/466582-032 Circe
3KH33/466582-033 Ecosystem
3KH34/466582-034 Knack
3KH35/466582-035 Watt
3KH36/466582-036 Epiphany
3KH37/466582-037 Gamma
3KH38/466582-038 Taxicab
3KH39/466582-039 Varietal
3KH40/466582-040 Tale

Firma continued

3KH41/466582-041 Elemental
3KH42/466582-042 Cuff
3KH43/466582-043 Emu
3KH44/466582-044 Tempeh
3KH45/466582-045 Tephra
3KH46/466582-046 Shellac
3KH47/466582-047 Emporium
3KH48/466582-048 Keratin
3KH49/466582-049 Camwood
3KH50/466582-050 Gloam
3KH51/466582-051 Novela
3KH52/466582-052 Fruitpunch
3KH53/466582-053 Decant
3KH54/466582-054 Milkshake
3KH55/466582-055 Metaphysic
3KH56/466582-056 Carafe
3KH57/466582-057 Voyager
3KH58/466582-058 Tenebrous
3KH59/466582-059 Subtext
3KH60/466582-060 Silent

Gemma Multi – Maharam

55" wide
85% wool
15% nylon
ZGF01/466569-001 Andromeda
ZGF02/466569-002 Dappled
ZGF03/466569-003 Lyra
ZGF04/466569-004 Flaunt
ZGF05/466569-005 Celluloid
ZGF06/466569-006 Hydrozoa
ZGF07/466569-007 Firefly
ZGF08/466569-008 Pisces
ZGF09/466569-009 Strath
ZGF10/466569-010 Erosion
ZGF11/466569-011 Cabaret
ZGF12/466569-012 Candytuft
ZGF13/466569-013 Juice
ZGF14/466569-014 Fairground
ZGF15/466569-015 Copperplate
ZGF16/466569-016 Sunbird
ZGF17/466569-017 Cinematic
ZGF18/466569-018 Clairvoyant
ZGF19/466569-019 Crocus

Gemma Multi continued

ZGF20/466569-020 Memoir
ZGF21/466569-021 Roulette
ZGF22/466569-022 Voltaic
ZGF23/466569-023 Compote
ZGF24/466569-024 Lambent
ZGF25/466569-025 Twister
ZGF26/466569-026 Chronicle
ZGF27/466569-027 Sidereal
ZGF28/466569-028 Tanzanite
ZGF29/466569-029 Crystalize
ZGF30/466569-030 Chromium
ZGF31/466569-031 Pallium
ZGF32/466569-032 Spectre
ZGF33/466569-033 Courgette
ZGF34/466569-034 Viper
ZGF35/466569-035 Sunlit
ZGF36/466569-036 Heavenly
ZGF37/466569-037 Vernal
ZGF38/466569-038 Cress
ZGF39/466569-039 Limn
ZGF40/466569-040 Horseradish
ZGF41/466569-041 Shandy
ZGF42/466569-042 Granary
ZGF43/466569-043 Percolate
ZGF44/466569-044 Motor
ZGF45/466569-045 Unicorn
ZGF46/466569-046 Lobster
ZGF47/466569-047 Rhododendron
ZGF48/466569-048 Taffy
ZGF49/466569-049 Rishi
ZGF50/466569-050 Backcountry
ZGF51/466569-051 Buckthorn
ZGF52/466569-052 Coniferous
ZGF53/466569-053 Delphic
ZGF54/466569-054 Hieroglyph
ZGF55/466569-055 Eiderdown
ZGF56/466569-056 Sandbar
ZGF57/466569-057 Tanager

Gemma Multi Reverse – Maharam

55" wide
85% wool
15% nylon
ZGF58/466569-101 Andromeda
Reverse
ZGF59/466569-102 Dappled
Reverse
ZGF60/466569-103 Lyra
Reverse
ZGF61/466569-104 Flaunt
Reverse
ZGF62/466569-105 Celluloid
Reverse
ZGF63/466569-106 Hydrozoa
Reverse
ZGF64/466569-107 Firefly
Reverse
ZGF65/466569-108 Pisces
Reverse
ZGF66/466569-109 Strath
Reverse
ZGF67/466569-110 Erosion
Reverse
ZGF68/466569-111 Cabaret
Reverse
ZGF69/466569-112 Candytuft
Reverse
ZGF70/466569-113 Juice
Reverse
ZGF71/466569-114 Fairground
Reverse
ZGF72/466569-115 Copperplate
Reverse
ZGF73/466569-116 Sunbird
Reverse
ZGF74/466569-117 Cinematic
Reverse
ZGF75/466569-118 Clairvoyant
Reverse
ZGF76/466569-119 Crocus
Reverse

Price category 10 continued on next page

- Maharam textiles are on assigned lead times **A** unless otherwise noted.
- Fabric numbers are listed as Herman Miller fabric number/Maharam fabric number.

Maharam® Colors — Seating

continued

Price Category 10

continued

Price Category A

Appendix: Maharam Colors — Seating

Gemma Multi Reverse *continued*

ZGF77/466569-120	Memoir
	Reverse
ZGF78/466569-121	Roulette
	Reverse
ZGF79/466569-122	Voltaic
	Reverse
ZGF80/466569-123	Compote
	Reverse
ZGF81/466569-124	Lambent
	Reverse
ZGF82/466569-125	Twister
	Reverse
ZGF83/466569-126	Chronicle
	Reverse
ZGF84/466569-127	Sidereal
	Reverse
ZGF85/466569-128	Tanzanite
	Reverse
ZGF86/466569-129	Crystalize
	Reverse
ZGF87/466569-130	Chromium
	Reverse
ZGF88/466569-131	Pallium
	Reverse
ZGF89/466569-132	Spectre
	Reverse
ZGF90/466569-133	Courgette
	Reverse
ZGF91/466569-134	Viper
	Reverse
ZGF92/466569-135	Sunlit
	Reverse
ZGF93/466569-136	Heavenly
	Reverse
ZGF94/466569-137	Vernal
	Reverse
ZGF95/466569-138	Cress
	Reverse
ZGF96/466569-139	Limn
	Reverse

Gemma Multi Reverse *continued*

ZGF97/466569-140	Horseradish
	Reverse
ZGF98/466569-141	Shandy
	Reverse
ZGF99/466569-142	Granary
	Reverse
ZGFA0/466569-143	Percolate
	Reverse
ZGFA1/466569-144	Motor
	Reverse
ZGFA2/466569-145	Unicorn
	Reverse
ZGFA3/466569-146	Lobster
	Reverse
ZGFA4/466569-147	Rhododendron
	Reverse
ZGFA5/466569-148	Taffy
	Reverse
ZGFA6/466569-149	Rishi
	Reverse
ZGFA7/466569-150	Backcountry
	Reverse
ZGFA8/466569-151	Buckthorn
	Reverse
ZGFA9/466569-152	Coniferous
	Reverse
ZGFB0/466569-153	Delphic
	Reverse
ZGFB1/466569-154	Hieroglyph
	Reverse
ZGFB2/466569-155	Eiderdown
	Reverse
ZGFB3/466569-157	Tanager
	Reverse

Petra - Maharam

55" wide	
70% wool	
19% linen	
11% nylon	
ZP401/466580-001	Hieroglyph
ZP402/466580-002	Interior
ZP403/466580-003	Samovar
ZP404/466580-004	Calcite
ZP405/466580-005	Silversmith
ZP406/466580-006	Rivet
ZP407/466580-007	Carpolite
ZP408/466580-008	Bonbon
ZP409/466580-009	Dreamy
ZP410/466580-010	Bejewel
ZP411/466580-011	Sashimi
ZP412/466580-012	Spirula
ZP413/466580-013	Chalet
ZP414/466580-014	Reindeer
ZP415/466580-015	Nostalgia
ZP416/466580-016	Trove
ZP417/466580-017	Narcissus
ZP418/466580-018	Yurt
ZP419/466580-019	Congee
ZP420/466580-020	Genepy
ZP421/466580-021	Herbaceous
ZP422/466580-022	Paddock
ZP423/466580-023	Precious
ZP424/466580-024	Biome
ZP425/466580-025	Tinted
ZP426/466580-026	Pelagic
ZP427/466580-027	Bluebill
ZP428/466580-028	Chicory
ZP429/466580-029	Eaglet
ZP430/466580-030	Permafrost
ZP431/466580-031	Atlantic
ZP432/466580-032	Airstream
ZP433/466580-033	Debonair

No fabrics available at this time.

- Maharam textiles are on assigned lead times A unless otherwise noted.
- Fabric numbers are listed as Herman Miller fabric number/Maharam fabric number.

Maharam® Colors — Seating

continued

Price Category B

Medium – Maharam

54" wide
100% polyester
VM01/463490-001 Raven
VM02/463490-002 Smoke
VM03/463490-003 Alloy
VM04/463490-004 Flax
VM07/463490-007 Espresso
VM14/463490-014 Laser
VM16/463490-016 Port
VM22/463490-022 Marina
VM29/463490-029 Pistachio
VM32/463490-032 Prospect
VM36/463490-036 Delight
VM39/463490-039 Nautical
VM40/463490-040 Pool
VM44/463490-044 Washed
VM45/463490-045 Sculpture
VM46/463490-046 Thatched
VM47/463490-047 Hike
VM48/463490-048 Tangle
VM49/463490-049 Pacific
VM50/463490-050 Cosmic
VM51/463490-051 Cascade
VM52/463490-052 Blackberry
VM53/463490-053 Nasturtium

Messenger – Maharam

54" wide
78% recycled polyester
15% polyester, 7% nylon
TI07/458640-007 Shadow
TI24/458640-024 Poppy
TI25/458640-025 Mao
TI29/458640-029 Onyx *
TI31/458640-031 Cloud *
TI38/458640-038 Depth *
TI40/458640-040 Nile *

Messenger continued

TI41/458640-041 Azure *
TI45/458640-045 Cactus *
TI46/458640-046 Ice *
TI48/458640-048 Neon
TI50/458640-050 Hydrangea
TI53/458640-053 Tangelo
TI54/458640-054 Lumine *
TI58/458640-058 Snow **
TI60/458640-060 Peridot
TI61/458640-061 Capri *
TI62/458640-062 Ultramarine
TI63/458640-063 Squall
TI66/458640-066 Cassis
TI67/458640-067 Aster
TI69/458640-069 Cherry
TI70/458640-070 Vibrant
TI71/458640-071 Satsuma *
TI72/458640-072 Maize
TI76/458640-076 Fossil
TI77/458640-077 Ash
TI78/458640-078 Tusk
TI79/458640-079 Oyster
TI81/458640-081 Husk
TI84/458640-084 Robust
TI85/458640-085 Beyond
TI86/458640-086 Voyage *
TI87/458640-087 Everglade
TI89/458640-089 Blanch **
TI90/458640-090 Longspur
TI91/458640-091 Vireo
TI92/458640-092 Dipper
TI93/458640-093 Gale
TI94/458640-094 Hunter
TI95/458640-095 Lime
TI96/458640-096 Apple
TI97/458640-097 Krill
TI98/458640-098 Catalyst

* Colors available on 20-day lead time.

** Colors not available on Valor Seating.

Price Category C

Manner - Maharam

54" wide
100% recycled polyester
Z2701/466177-001 Magic
Z2702/466177-002 Carob
Z2703/466177-003 Porpoise
Z2704/466177-004 Flint
Z2705/466177-005 Hush
Z2706/466177-006 Nuance
Z2711/466177-011 Ember
Z2712/466177-012 Wagon
Z2713/466177-013 Ablaze
Z2714/466177-014 Peel
Z2716/466177-016 Butterscotch
Z2717/466177-017 Harvest
Z2720/466177-020 Parakeet
Z2722/466177-022 Aquatic
Z2723/466177-023 Cottage
Z2724/466177-024 Dahlia
Z2725/466177-025 Vivid
Z2726/466177-026 Basin
Z2727/466177-027 Schooner
Z2728/466177-028 Slope
Z2729/466177-029 Silverpoint
Z2730/466177-030 Lattice
Z2731/466177-031 Smoky
Z2732/466177-032 Magnetic
Z2733/466177-033 Woad
Z2734/466177-034 Resolute
Z2735/466177-035 Cruise
Z2736/466177-036 Atmospheric
Z2737/466177-037 Cloudburst
Z2738/466177-038 Tidewater
Z2739/466177-039 Firth
Z2740/466177-040 Oceanside
Z2741/466177-041 Grandeur
Z2742/466177-042 Comfort
Z2743/466177-043 Dill
Z2744/466177-044 Poplar
Z2745/466177-045 Citronella
Z2746/466177-046 Passerine

Manner continued

Z2747/466177-047 Southwest
Z2748/466177-048 Roseate
Z2749/466177-049 Charisma
Z2750/466177-050 Siltstone
Z2751/466177-051 Kimono
Z2752/466177-052 Valiant
Z2753/466177-053 Baroness

Merit - Maharam

54" wide
76% post-industrial recycled polyester
24% polyester
PFOA-Free stain resistant
88Z01/466444-001 Trickle
88Z02/466444-002 Beluga
88Z03/466444-003 Gunmetal
88Z04/466444-004 Blackout
88Z05/466444-005 Superior
88Z06/466444-006 Ocean
88Z07/466444-007 Highborn
88Z08/466444-008 Immersed
88Z09/466444-009 Rainfall
88Z10/466444-010 Blizzard
88Z11/466444-011 Poolside
88Z12/466444-012 Steel
88Z13/466444-013 Zircon
88Z14/466444-014 Ripple
88Z15/466444-015 Aegean
88Z16/466444-016 Armada
88Z17/466444-017 Hedera
88Z18/466444-018 Rainforest
88Z19/466444-019 Gator
88Z20/466444-020 Vineyard
88Z21/466444-021 Pine
88Z22/466444-022 Kiwi
88Z23/466444-023 Kookaburra
88Z24/466444-024 Bellini
88Z25/466444-025 Sunflower
88Z26/466444-026 Sandstorm

Price category C continued on next page

Appendix: Maharam Colors — Seating

- Maharam textiles are on assigned lead times A unless otherwise noted.
- Fabric numbers are listed as Herman Miller fabric number/Maharam fabric number.

Maharam® Colors – Seating

continued

Price Category C

continued

Merit continued

88Z27/466444-027	Mudder
88Z28/466444-028	Lynx
88Z29/466444-029	Farro
88Z30/466444-030	Manila
88Z31/466444-031	Starfish
88Z32/466444-032	Brass
88Z33/466444-033	Arrow
88Z34/466444-034	Gelato
88Z35/466444-035	Nectarine
88Z36/466444-036	Macaron
88Z37/466444-037	Alert
88Z38/466444-038	Goji
88Z39/466444-039	Cabernet
88Z40/466444-040	Eggplant
88Z41/466444-041	Hawk
88Z42/466444-042	Stag
88Z43/466444-043	Overcast

Metric – Maharam

54" wide	
51% recycled polyester	
49% polyester	
Z302/466014-002	Fog
Z303/466014-003	Fleece
Z312/466014-012	Cardinal
Z313/466014-013	Lava
Z318/466014-018	Pollen
Z320/466014-020	Alligator
Z323/466014-023	Tar
Z324/466014-024	Anchor
Z326/466014-026	Admiral
Z327/466014-027	Seaport
Z328/466014-028	Scuba
Z329/466014-029	Skate
Z330/466014-030	Hopscotch
Z331/466014-031	Film
Z332/466014-032	Whale
Z333/466014-033	Downpour
Z334/466014-034	Midday
Z335/466014-035	Talisman

Metric continued

Z336/466014-036	Hedgerow
Z337/466014-037	Snorkel
Z338/466014-038	Highway
Z339/466014-039	Canary
Z340/466014-040	Sunny
Z341/466014-041	Aztec
Z342/466014-042	Fruit
Z343/466014-043	Galah
Z344/466014-044	Kiln
Z345/466014-045	Moth

Milestone – Maharam

54" wide	
78% post-industrial recycled polyester	
15% polyester	
7% nylon	
ZML22/403901-022	Pewter
ZML26/403901-026	Ebony
ZML47/403901-047	Rush
ZML55/403901-055	Embrace
ZML57/403901-057	Coffee
ZML58/403901-058	Bison
ZML61/403901-061	Tiger Lily
ZML71/403901-071	Daffodil
ZML78/403901-078	Spruce
ZML79/403901-079	Fountain

Murmur - Maharam

55" wide	
100% polyester	
PFOA-Free stain resistant	
8EY01/466446-001	Gust
8EY02/466446-002	Harmonica
8EY03/466446-003	Canopy
8EY04/466446-004	Dim
8EY05/466446-005	Peppercorn
8EY06/466446-006	Cauldron
8EY07/466446-007	Conquer
8EY08/466446-008	Rapids
8EY09/466446-009	Seawater
8EY10/466446-010	Baby
8EY11/466446-011	Elderberry
8EY12/466446-012	Iceberg
8EY13/466446-013	Tallgrass
8EY14/466446-014	Underground
8EY15/466446-015	Biome
8EY16/466446-016	Cask
8EY17/466446-017	Argan
8EY18/466446-018	Sundown
8EY19/466446-019	Ignite
8EY20/466446-020	Sultry
8EY21/466446-021	Sangria

Price Category D

Bluff - Maharam

54" wide	
100% polyurethane	
Ink-resistant protective top coat	
Polyester backing	
8I801/466489-001	Loom
8I802/466489-002	Helm
8I803/466489-003	Cruller
8I804/466489-004	Folklore
8I805/466489-005	Beguile
8I806/466489-006	Sherpa
8I807/466489-007	Teleport
8I808/466489-008	Annex
8I809/466489-009	Lorimer
8I810/466489-010	Cinema
8I811/466489-011	Zip
8I812/466489-012	Coach
8I813/466489-013	Supernova
8I814/466489-014	Pirate
8I815/466489-015	Academy
8I816/466489-016	Disco
8I817/466489-017	Equator
8I818/466489-018	Brink
8I819/466489-019	Scene
8I820/466489-020	Petrichor
8I821/466489-021	Exotic
8I822/466489-022	Fauna
8I823/466489-023	Calabash
8I824/466489-024	Fuscous
8I825/466489-025	Wildling
8I826/466489-026	Blitz
8I827/466489-027	Allspice
8I828/466489-028	Lumos
8I829/466489-029	Pilot
8I830/466489-030	Jukebox
8I831/466489-031	Dugout
8I832/466489-032	Claret
8I833/466489-033	Flamenco

Mode – Maharam

54" wide
80% post-consumer recycled polyester
20% polyester
PFOA-Free stain resistant finish

- Maharam textiles are on assigned lead times **A** unless otherwise noted.
- Fabric numbers are listed as Herman Miller fabric number/Maharam fabric number.

Price category D continued on next page

Maharam® Colors – Seating

continued

Price Category D

continued

Mode continued
ZMD01/466337-001 Stroll
ZMD02/466337-002 Intaglio
ZMD03/466337-003 Ominous
ZMD04/466337-004 Machine
ZMD05/466337-005 Talus
ZMD06/466337-006 Marsh
ZMD07/466337-007 Hollow
ZMD08/466337-008 Sycamore
ZMD09/466337-009 Clavicle
ZMD10/466337-010 Billygoat
ZMD11/466337-011 Spindle
ZMD12/466337-012 Lemon
ZMD13/466337-013 Oxeve
ZMD14/466337-014 Henge
ZMD15/466337-015 Goldenrod
ZMD16/466337-016 Cottontail
ZMD17/466337-017 Lioness
ZMD18/466337-018 Oriole
ZMD19/466337-019 Rust
ZMD20/466337-020 Carotene
ZMD21/466337-021 Blush
ZMD22/466337-022 Vermilion
ZMD23/466337-023 Alder
ZMD24/466337-024 Kermes
ZMD25/466337-025 Barberry
ZMD26/466337-026 Petal
ZMD27/466337-027 Valley
ZMD28/466337-028 Odyssey
ZMD29/466337-029 Ballpoint
ZMD30/466337-030 Toile
ZMD31/466337-031 Paradise
ZMD32/466337-032 Angelfish
ZMD33/466337-033 Denim
ZMD34/466337-034 Crush
ZMD35/466337-035 Jetty
ZMD36/466337-036 Saltwater
ZMD37/466337-037 Mallard
ZMD38/466337-038 Celtic
ZMD39/466337-039 Eucalyptus
ZMD40/466337-040 Bonsai
ZMD41/466337-041 Sassafras
ZMD42/466337-042 Yucca
ZMD43/466337-043 Lichen

Price Category E

Article – Maharam
54" wide
100% vinyl
ZAT08/458600-008 Marina
ZAT13/458600-013 Flume
ZAT14/458600-014 Storm
ZAT15/458600-015 Toast
ZAT19/458600-019 Fleece
ZAT22/458600-022 Stone
ZAT26/458600-026 Mercury
ZAT29/458600-029 Bluegrass
ZAT31/458600-031 Truffle
ZAT32/458600-032 Gravel
ZAT33/458600-033 Value
ZAT34/458600-034 Tint
ZAT35/458600-035 Snowflake
ZAT36/458600-036 Chalice
ZAT37/458600-037 Trail
ZAT38/458600-038 Pyramid
ZAT39/458600-039 Desert
ZAT40/458600-040 Lei
ZAT41/458600-041 Rouge
ZAT42/458600-042 Karma
ZAT43/458600-043 Opal
ZAT44/458600-044 Periwinkle
ZAT45/458600-045 Vampire
ZAT46/458600-046 Surf
ZAT47/458600-047 Plumage

Roster - Maharam
54" wide
68% post-consumer recycled polyester
32% polyester
PFOA-Free stain resistant
Acrylic backing
ZR201/466445-001 Jacana
ZR202/466445-002 Wythe
ZR203/466445-003 Grosgrain
ZR204/466445-004 Ceremony
ZR205/466445-005 Breton
ZR206/466445-006 Frigate

Price Category F

Apt – Maharam
54" wide
100% polyurethane/silicone
Ink-resistant protective top coat
Polyester backing
82T12/466392-012 Iris
82T13/466392-013 Nocturnal
82T14/466392-014 Fluid
82T15/466392-015 Eden
82T16/466392-016 Galactic
82T17/466392-017 Shoreline
82T18/466392-018 Jade
82T19/466392-019 Garden
82T20/466392-020 Botanic
82T21/466392-021 Chartreuse
82T23/466392-023 Lyric
82T24/466392-024 Turmeric
82T25/466392-025 Bengal
82T26/466392-026 Core
82T27/466392-027 Mantle
82T28/466392-028 Sorbet
82T32/466392-032 Oak
82T33/466392-033 Castle
82T34/466392-034 Follow
82T35/466392-035 Elixir
82T36/466392-036 Charm
82T37/466392-037 Descend
82T38/466392-009 Sketch
82T39/466392-010 Glacier
82T40/466392-031 Fortress
82T41/466392-030 Lotus
82T42/466392-001 Coconut
82T43/466392-011 Cobblestone
82T44/466392-029 Bloom
82T45/466392-022 Crepe
82T46/466392-006 Hickory
82T47/466392-007 Constellation
82T48/466392-008 Labyrinth
82T49/466392-002 Vibe
82T50/466392-003 Stampede
82T51/466392-004 Lumber
82T52/466392-005 Gingerbread

Price category F continued on next page

- Maharam textiles are on assigned lead times A unless otherwise noted.
- Fabric numbers are listed as Herman Miller fabric number/Maharam fabric number.

Maharam® Colors — Seating

continued

Price Category F

continued

<p>Brindle - Maharam</p> <p>58" wide</p> <p>100% polyester</p> <p>PFOA-free stain resistant</p> <p>Acrylic backing</p> <p>87101/466418-001 Calico</p> <p>87102/466418-002 Mauve</p> <p>87103/466418-003 Torch</p> <p>87104/466418-004 Burnt</p> <p>87105/466418-005 Barn</p> <p>87106/466418-006 Pharaoh</p> <p>87107/466418-007 Sandbur</p> <p>87108/466418-008 Jungle</p> <p>87109/466418-009 Inland</p> <p>87110/466418-009 Seagrass</p> <p>87111/466418-009 Watercolor</p> <p>87112/466418-009 Aquarium</p> <p>87113/466418-009 Drill</p>	<p>Instill – Maharam</p> <p>54" wide</p> <p>100% polyurethane</p> <p>Ink-resistant protective top coat</p> <p>Polyester backing</p> <p>74M01/466351-001 Page</p> <p>74M02/466351-002 Limestone</p> <p>74M03/466351-003 Bobwhite</p> <p>74M04/466351-004 Loafer</p> <p>74M05/466351-005 Moor</p> <p>74M06/466351-006 Barley</p> <p>74M07/466351-007 Shaker</p> <p>74M08/466351-008 Doe</p> <p>74M09/466351-009 Ride</p> <p>74M10/466351-010 Squire</p> <p>74M11/466351-011 Tannin</p> <p>74M12/466351-012 Vitis</p> <p>74M14/466351-014 Quail</p> <p>74M15/466351-015 Brittanica</p> <p>74M16/466351-016 Narwhal</p> <p>74M17/466351-017 Synth</p> <p>74M18/466351-018 Stowaway</p> <p>74M19/466351-019 Koala</p> <p>74M20/466351-020 Dorsal</p> <p>74M21/466351-021 Stealth</p>	<p>Keen - Maharam</p> <p>54" wide</p> <p>61% polyester</p> <p>39% polyolefin</p> <p>PFOA-Free stain resistant</p> <p>Acrylic backing</p> <p>89N01/466433-001 Gaur</p> <p>89N02/466433-002 Lock</p> <p>89N03/466433-003 Elk</p> <p>89N04/466433-004 Oatmeal</p> <p>89N05/466433-005 Lakefront</p> <p>89N06/466433-006 Argent</p> <p>89N07/466433-007 Coyote</p> <p>89N08/466433-008 Eventide</p> <p>89N09/466433-009 Canal</p> <p>89N10/466433-010 Rosemary</p> <p>89N11/466433-011 Herb</p> <p>89N12/466433-012 Ruby</p> <p>89N13/466433-013 Loganberry</p>	<p>Loop - Maharam</p> <p>57" wide</p> <p>48% post-industrial recycled polyester</p> <p>26% polyester</p> <p>26% post-consumer recycled polyester</p> <p>PFOA-Free stain resistant</p> <p>Acrylic Backing</p> <p>ZLL01/466469-001 Opossum</p> <p>ZLL02/466469-002 Foundation</p> <p>ZLL03/466469-003 Naval</p> <p>ZLL04/466469-004 Buoyant</p> <p>ZLL05/466469-005 Mockingbird</p> <p>ZLL06/466469-006 Dynasty</p> <p>ZLL07/466469-007 Zori</p> <p>ZLL08/466469-008 Wildfire</p> <p>ZLL09/466469-009 Floral</p> <p>ZLL10/466469-010 Penguin</p>	<p>Conduit - Maharam</p> <p>58" wide</p> <p>100% polyester</p> <p>PFOA-free stain resistant</p> <p>Acrylic backing</p> <p>87Z01/466428-001 Space</p> <p>87Z02/466428-002 Syrup</p> <p>87Z03/466428-003 Nimbus</p> <p>87Z04/466428-004 Greystone</p> <p>87Z05/466428-005 Fawn</p> <p>87Z06/466428-006 Ghost</p> <p>87Z07/466428-007 Caribbean</p> <p>87Z08/466428-008 Canal</p> <p>87Z09/466428-009 Bonfire</p>	<p>Ledger – Maharam</p> <p>54" wide</p> <p>100% polyurethane</p> <p>V9G1/463770-001 001</p> <p>V9G2/463770-002 002</p> <p>V9G3/463770-003 003</p> <p>V9G4/463770-004 004</p> <p>V9GG/463770-017 017</p> <p>V9GQ/463770-025 025</p> <p>V9GS/463770-026 026</p> <p>V9GU/463770-028 028</p> <p>V9GV/463770-029 029</p> <p>V9GW/463770-030 030</p> <p>V9GX/463770-031 031</p> <p>V9GY/463770-032 032</p> <p>V9G18/463770-042 042</p> <p>V9G19/463770-043 043</p> <p>V9G20/463770-044 044</p> <p>V9G21/463770-045 045</p> <p>V9G22/463770-046 046</p>	<p>Multiply - Maharam</p> <p>58" wide</p> <p>57% post-consumer recycled polyester</p> <p>43% post-industrial recycled polyester</p> <p>PFOA-Free stain resistant</p> <p>Acrylic Backing</p> <p>82A01/466341-001 Winter</p> <p>82A02/466341-002 Encore</p> <p>82A03/466341-003 Swing</p> <p>82A04/466341-004 Contrast</p> <p>82A05/466341-005 Sterling</p> <p>82A06/466341-006 Daze</p> <p>82A07/466341-007 Sway</p> <p>82A08/466341-008 Sailor</p> <p>82A09/466341-009 Mystique</p> <p>82A10/466341-010 Deep</p> <p>82A11/466341-011 Craft</p> <p>82A12/466341-012 Town</p> <p>82A13/466341-013 Limit</p> <p>82A14/466341-014 Tamale</p>
--	--	--	---	---	---	---

Price category F continued on next page

- Maharam textiles are on assigned lead times A unless otherwise noted.
- Fabric numbers are listed as Herman Miller fabric number/Maharam fabric number.

Maharam® Colors — Seating

continued

Price Category F

continued

Pepper - Maharam
58" wide
49% polyester
41% post-industrial recycled polyester
10% post-consumer recycled polyester
PFOA-Free stain resistant
Acrylic Backing
8LW01/466486-001 Dojo
8LW02/466486-002 Marengo
8LW03/466486-003 Harlequin
8LW04/466486-004 Pavlova
8LW06/466486-006 Achioté
8LW07/466486-007 Essence
8LW08/466486-008 Genome
8LW09/466486-009 Myriad
8LW10/466486-010 Terrarium

Sequence - Maharam
54" wide
100% solution-dyed polyolefin
with silver-based antimicrobial
Z3104/466179-004 Alfresco
Z3105/466179-005 Plunge
Z3107/466179-007 Veranda
Z3109/466179-009 Flare

Strum - Maharam
54" wide
100% polyurethane
with silver-based antimicrobial
Z3301/466122-001 Overcast
Z3302/466122-002 Ridge
Z3304/466122-004 Pigeon
Z3307/466122-007 Bur
Z3308/466122-008 Abalone
Z3311/466122-011 Wheat
Z3312/466122-012 Lemongrass

Price Category G

Compound - Maharam
54" wide
100% polyurethane
silane-based antimicrobial
ZC201/466196-001 001
ZC203/466196-003 003
ZC204/466196-004 004
ZC205/466196-005 005
ZC206/466196-006 006
ZC207/466196-007 007
ZC208/466196-008 008
ZC209/466196-009 009
ZC210/466196-010 010
ZC211/466196-011 011
ZC212/466196-012 012
ZC213/466196-013 013
ZC214/466196-014 014
ZC215/466196-015 015
ZC216/466196-016 016
ZC217/466196-017 017
ZC218/466196-018 018
ZC219/466196-019 019

Fold - Maharam
54" wide
100% polyurethane
Polyester backing
ZF101/466292-001 Jet
ZF102/466292-002 Chalk
ZF103/466292-003 Smoke
ZF105/466292-005 Fatigue
ZF106/466292-006 Splash
ZF107/466292-007 Apple
ZF108/466292-008 Moss
ZF110/466292-010 Midnight

Gild - Maharam
54" wide
100% non-phthalate vinyl
Ink-resistant protective top coat
Polyester backing
8AR01/466432-005 Grapevine
8AR02/466432-009 Frosting
8AR03/466432-007 Smokey
8AR04/466432-003 Skylight
8AR05/466432-011 Sandstone
8AR06/466432-004 Hurricane
8AR07/466432-002 Wreath
8AR08/466432-001 Rainforest
8AR09/466432-012 Fudge
8AR10/466432-010 Lantern
8AR11/466432-006 Planet
8AR12/466432-008 Reflection

Pare - Maharam
54" wide
52% wool
26% polyester
22% nylon
PFOA-free stain resistant finish
ZPR01/466359-001 Polaris
ZPR02/466359-002 Mountain
ZPR04/466359-004 Fresco
ZPR06/466359-006 Wink
ZPR07/466359-007 Concord
ZPR08/466359-008 Strawberry
ZPR09/466359-009 Solar
ZPR10/466359-010 Amulet
ZPR11/466359-011 Zest
ZPR12/466359-012 Elmwood
ZPR13/466359-013 Thyme
ZPR17/466359-017 Blueberry

Price category G continued on next page

Appendix: Maharam Colors — Seating

- Maharam textiles are on assigned lead times **A** unless otherwise noted.
- Fabric numbers are listed as Herman Miller fabric number/Maharam fabric number.

Maharam® Colors — Seating

continued

Price Category G

continued

Pick Crypton - Maharam
54" wide
100% polyester
Crypton finish and backing
ZP107/466235-007 Fresh
ZP108/466235-008 Cool

Runner - Maharam
54" wide
57% post-industrial recycled polyester
43% post-consumer recycled polyester
ZRF01/466108-001 Bluff
ZRF03/466108-003 Grove
ZRF04/466108-004 Starboard
ZRF05/466108-005 Plot
ZRF06/466108-006 Carousel

Price Category H

Circles — Maharam
55" wide
70% cotton
30% polyester
ZT01/458310-001 Khaki
ZT02/458310-002 Fatigue
ZT03/458310-003 Document
ZT04/458310-004 Engine

Dot Pattern — Maharam
55" wide
71% cotton
29% polyester
ZK01/458300-001 Document
ZK02/458300-002 Taupe
ZK04/458300-004 Red
ZK05/458300-005 Navy

Offset — Maharam
54" wide
40% cotton
36% nylon
24% wool
ZQF03/465951-003 Coast
ZQF05/465951-005 Oasis

Small Dot Pattern — Maharam
55" wide
71% cotton
29% polyester
ZL01/458320-001 Document
ZL02/458320-002 Sand
ZL03/458320-003 Khaki
ZL04/458320-004 Taupe
ZL05/458320-005 Charcoal
ZL06/458320-006 Document
Reverse
ZL07/458320-007 Red
ZL08/458320-008 Yellow
ZL09/458320-009 Green

Price Category I

Cursive — Maharam
54" wide
67% solution-dyed acrylic
33% solution-dyed polyester
PFOA-Free stain resistant
7CW01/466335-001 Fast
7CW03/466335-003 Beachcomb
7CW05/466335-005 Swift
7CW07/466335-007 Inkwell
7CW08/466335-008 Rubber

Study - Maharam
54" wide
73% solution-dyed acrylic
27% solution-dyed polyester
ZSY01/466269-001 001
ZSY02/466269-002 002
ZSY03/466269-003 003
ZSY04/466269-004 004
ZSY05/466269-005 005

- Maharam textiles are on assigned lead times A unless otherwise noted.
- Fabric numbers are listed as Herman Miller fabric number/Maharam fabric number.

Maharam® Colors — Seating

continued

Price Category J-K

No fabrics available at this time.

Price Category L

Minicheck - Maharam

55" wide
 78% cotton
 22% polyester
 PFOA-Free stain resistant finish
 ZMK01/466268-001 Black/
 White

Price Category M

Fruit - Maharam

54" wide
 55% cotton
 32% nylon
 13% post-consumer recycled
 polyester
 PFOA-Free stain resistant finish
 Acrylic backing
 ZF201/466262-001 Opal
 ZF202/466262-002 Lime
 ZF203/466262-003 Olive
 ZF204/466262-004 Sky
 ZF207/466262-007 Russet

Price Category N-Z

No fabrics available at this time.

- Maharam textiles are on assigned lead times **A** unless otherwise noted.
- Fabric numbers are listed as Herman Miller fabric number/Maharam fabric number.

For more information about our products and services or to see a list of dealers, please visit us at HermanMiller.com or call (800) 851 1196.

© 2023 Herman Miller, Inc., Zeeland, Michigan

Distribution Rights

Working together since 1956, Herman Miller and Vitra are the authentic sources of designs by Charles and Ray Eames, Alexander Girard, and George Nelson. All the designs shown in this book are protected by law. Herman Miller has obtained all rights to make and sell these designs. Also, Herman Miller holds exclusive worldwide manufacturing and distribution rights for these products with the following exceptions:

Charles and Ray Eames, George Nelson, and Alexander Girard—Worldwide distribution rights for furniture in all areas except Europe and the Middle East. For those areas, please contact Vitra.

Isamu Noguchi—Worldwide distribution rights for the Noguchi Rudder Table. Distribution rights for the Noguchi Table in North America and Central America only. For all other areas, please contact Vitra.

Magis—Exclusive distribution rights in the US and Canada. For all other areas, please contact Magis.

© **HermanMiller**, 3D Intelligent, 8Z Pellicle, AO, Action Office, Aeron, Aside, Bubble Lamps, Canvas Office Landscape, Caper, Celle, Cosm, Co/Struc, Daisyone, Distil, Eames, Eco-Dematerialized, Embody, Envelop, Ethospace, Exclave, Fine-Tune, FlexFront, Flo, Formcoat, Formwork, Ground Cloth, Intent, Kinemat, Layout Studio, Lino, Live Unframed, Living Office, Maharam, Meridian, Mirra, Motia, Nelson, Pari, Pellicle, Perspectives, Plex, PostureFit, PostureFit SL, Public Office Landscape, Sayl, Setu, Striad, Tu, Ubi, Verus, Wishbone, and Y-Tower are among the registered trademarks of Herman Miller, Inc., and its owned subsidiaries.

™ About Face, AireWeave, Airia, Ambit, Asari Chair by HermanMiller, Backfit, Bubbletack, Burdick Group, Butterfly Back, Canvas Vista, Cellular Suspension, Commend, Compass, Connect, DOT, Duracare, Durawrap, EnhancedAccess, Everywhere, Flex-Edge, Flute, Harmonic, Headway, Herman Miller Select, Hopsak 2, Iota, Keyless Entry, Latitude, Logic Mini, Logic Power Access Solutions, Lyris, Lyris 2, Made-to-Measure Storage, Mora, Multiscrim, Nevi, OE1, OE1 Workspace Collection, Overlay, Pixelated Support, Pronta, Renew, Sense, Soft Pad, Stackable, Stackable Storage, Swoop, Thrive, Tone, TriFlex, Twist, Wireframe, and Zeph are among the trademarks of Herman Miller, Inc., and its owned subsidiaries.

SM Herman Miller Options is among the service marks of Herman Miller, Inc.

AAP™ is a trademark of Extron Electronics.

Alexander Girard® is a registered trademark of The Alexander Girard Estate.

Chemsurf® is a registered trademark of Wilsonart International.

Corian® is a registered trademark of E. I. du Pont de Nemours and Company Corporation.

Crypton® is a registered trademark of Crypton, Inc.

DACRON® is a registered trademark of INVISTA S.a r.l.

Danzer® is a registered trademark of Danzer Holding AG.

Decora® is a registered trademark of Leviton Manufacturing Co., Inc.

Edelman® Leather is a registered trademark of Edelman Leather, Inc.

Extron® is a registered trademark of RGB Systems, Inc.

FENIX NTM® is a registered trademark of Arpa Industriale S.p.A.

FLEXNET™ is a trademark of Milliken & Company.

Floor Saver Glide® is a registered trademark of Carpin Manufacturing, Inc.

Forest Stewardship Council® is a registered trademark of the Forest Stewardship Council A.C. (FSC). We are FSC® certified (FSC® C102895).

FSC® is a registered trademark of the Forest Stewardship Council A.C. (FSC).

Geiger® is a registered trademark, and Bumper™, Saiba™, and Ward Bennett™ are trademarks, of Geiger International.

Hang-It-All® is a registered trademark of Lucia Eames Demetrios, d.b.a. Eames Office.

Holophane® is a registered trademark of Holophane.

Ingeo™ is a trademark of Cargill Dow LLC.

iPad® and Mac mini® are registered trademarks of Apple Inc.

Leviton® is a registered trademark of Leviton Manufacturing Co., Inc.

LifeSize® is a registered trademark of LifeSize Communications, Inc.

Logitech G® is a registered trademark of Logitech International S.A.

Magis®, Bombo®, and Me Too® are registered trademarks of Magis S.p.A.

MicrobeCare™ is a trademark of Parasol Medical LLC.

Microsoft® and Natural® Keyboard are registered trademarks of Microsoft Corporation.

Noguchi® and the Noguchi table configuration (trade dress) are registered trademarks, and Rudder Table™ is a trademark, of The Isamu Noguchi Foundation and Garden Museum.

Place Textiles® is a registered trademark of Place Textiles.

Sunbrella® is a registered trademark of Glen Raven, Inc.

SuperSeat™ is a trademark of Dahti Seating, a division of ITW.

Valor™ is among the trademarks owned by Nemschoff, Inc.