



GSA prices effective January 30, 2023  
(based on October 3, 2022, commercial price list)  
Published January 2024

## Multipurpose Seating Embody® Chairs

### **General Services Administration Federal Supply Service Authorized Federal Supply Schedule Price List**

Online access to contract ordering information, terms and conditions, up-to-date pricing, and the option to create an electronic delivery order is available through GSA Advantage!®, a menu-driven database system.

The Internet address for GSA Advantage! is [www.gsaadvantage.gov](http://www.gsaadvantage.gov).

Office Furniture  
FSC/PSC 7110/7125  
Contract Number: GS-03F-036DA  
UEI: Q2K3MSZ843D8  
Contract Period: December 21, 2015—December 20, 2025

MillerKnoll, Inc.  
855 East Main Avenue  
Zeeland, Michigan 49464  
(616) 654 3000 Phone  
(616) 654 8278 Fax  
[www.HermanMiller.com/government](http://www.HermanMiller.com/government)

Business Size: Large



# Contract Information

## 1a. Special Item Numbers (SIN)

SIN 33721

Furniture Systems, Computer Furniture, Filing and Storage, Tables and Accessories, Upholstered Seating and Multi-Purpose Seating, Project Management, Reconfiguration and Relocation Services, Design/Layout and Installation Services

SIN 33721P

Packaged Offices

SIN 337127

Modular Laboratory Furniture Systems

SIN 339113H

Healthcare Furniture

SIN OLM

Order-Level Materials (OLMs)

This SIN is only for products and/or services used in direct support of the purchase of new furniture. It requires approval from the ordering Contract Officer. Please contact your local MillerKnoll Inc. representative to discuss the appropriate use of this SIN.

SIN 532289

Leasing

Contact MillerKnoll Inc participating government dealer for current leasing information.

## 1b. Lowest Priced Model

SIN 33721:	BVP3.S	\$7.27
SIN 33127:	TW113	\$5.81
SIN 339113H:	CR900NR	\$483.80

## 1c. Service Rates

Project Management

Furniture Project Manager: \$64.75 per hour  
 Furniture Project Coordinator: \$49.00 per hour  
 Build-Out Project Manager: \$80.00 per hour

Reconfiguration and Relocation Services

Not to exceed \$55 per hour.

See \* Additional Notes for Installation & Reconfiguration and Relocation Services.

Design/Layout

Not to exceed \$65 per hour.

Installation Services

Not to exceed \$55 per hour (\$82.50 per hour for after-hours Installation).

See \* Additional Notes for Installation & Reconfiguration and Relocation Services.

## 2. Maximum Order

SIN 33721, 337127, NEW, OLM

\$250,000 net product value

SIN 33721P

\$250,000 net value

SIN 339113H

\$500,000 net product value

## 3. Minimum Order

\$100 net

## 4. Geographic Coverage

Continental U.S.

Orders for Alaska, Hawaii, and Puerto Rico will be shipped F.O.B. inland carrier point of exportation.

## 5. Point of Production

Zeeland, Ottawa County, Michigan

Spring Lake, Ottawa County, Michigan

## 6. Pricing

Prices shown are list. Discounts include Industrial Funding Fee.

SIN 33721

Standard Lead Time, Single Order Net Purchase \$100 - 250,000, includes approved Herman Miller Options Products.

Product Line	Discount From List
Action Office 1	73.8%
Action Office 2	73.8%
Aeron	64.5%
Ambit Workspace Solutions	74.3%
Aside	64.2%
C-Style Overhead Storage	73.8%
Canvas Office Landscape Channel	74.8%
Canvas Office Landscape Dock	74.8%
Canvas Metal Desk	74.8%
Canvas Office Landscape Metal Storage	74.8%
Canvas Office Landscape Private Office	74.8%
Canvas Office Landscape Wood Storage	74.8%
Canvas Office Landscape Vista	74.8%
Canvas Office Landscape Wall	74.8%
Caper	61.5%
Commend Nurses Station	73.3%
Cosm	61.7%
Eames® Conference & Dining Tables	73.6%
Easton Family	54.91%
Embody	59.7%
Energy Distribution Systems	73.8%
Ethospace System	73.8%
Everywhere™ Tables	73.8%
Exclave	61.7%
Fuld	59.7%
Headway™ Tables	73.8%
Intent Solution	58.7%

# Contract Information

continued

Layout Studio®	60.7%
Lighting	73.8%
Lino	63.7%
Meridian Laterals	67.3%
Meridian Pedestals	64.2%
Meridian Towers	62.7%
Meridian Storage	62.7%
Mirra 2	61.7%
Motia Tables	73.8%
Nemschoff	54.91%
Nevi™ Tables	73.8%
Nevi Link	73.8%
OE1 Boundary	72.8%
OE1 Micro Packs	73.8%
OE1 Storage	72.8%
OE1 Tables and Benching	73.8%
Overlay™	62.7%
Plex® Lounge Furniture	59.5%
Public Office Landscape	61.7%
Renew™ Tables	73.8%
Renew Link	73.8%
Sayl	62.2%
Setu	59.7%
Swoop Lounge Furniture	60.7%
Thrive Portfolio	62.0%
Thrive Portfolio-CBS Products Extension	62.0%
Tu Lateral Files	74.3%
Tu Pedestals	73.8%
Tu Storage	74.3%
Tu Towers	74.3%
Tu Wood Cases	74.3%
Tu Wood Cubbies	74.3%
Tu Wood Credenzas	74.3%
Tu Wood Pedestals	74.3%
Tu Wood Towers	74.3%
Valor™ Family	54.91%
Verus	63.7%
Zeph	60.2%

## Services

Please refer to section 19 for Terms and Conditions of Installation/ Reconfiguration and Relocation Services.

## Project Management

Services under this SIN may be used only in conjunction with the purchase of new furniture. Please contact your local MillerKnoll Inc. representative to discuss the available labor categories (listed below). The hourly rates listed are “Not To Exceed” or “NTE” values.

Furniture Project Manager: \$64.75 per hour  
 Furniture Project Coordinator: \$49.00 per hour  
 Build-Out Project Manager: \$80.00 per hour

## Reconfiguration and Relocation Services

Reconfiguration and Relocation Services will be provided by MillerKnoll Inc. or its participating dealer based on a fee not to exceed \$55 per hour.

See \* Additional Notes for Installation & Reconfiguration and Relocation Services.

## Design/Layout

Design service will be provided by MillerKnoll Inc. or its participating dealer based on a fee not to exceed \$65 per hour.

## Installation Services

Installation Services will be provided by MillerKnoll Inc. or its participating dealer based on a fee not to exceed \$55 per hour (\$82.50 per hour for after-hours Installation).

See \* Additional Notes for Installation & Reconfiguration and Relocation Services.

## SIN 337127

Standard Lead Time, Single Order Net Purchase \$100 - 250,000, includes approved Herman Miller Options Products.

<b>Product Line</b>	<b>Discount From List</b>
Action Lab	58.5%
Compass System	58.5%
Co/Struc System	58.5%
Healthcare Carts	18.0%
Mora System	58.5%
Bedside Cabinets	58.5%

## SIN 33721P

Packaged Office Furniture - Maximum Order \$250,000 (net).

Includes packaged furniture solutions for customers needing to furnish an office.

## SIN 339113H

Standard Lead Time, Single Order Net Purchase \$100 - 500,000, includes approved Herman Miller Options Products.

<b>Product Line</b>	<b>Discount From List</b>
Nemschoff Healthcare Furniture	54.91%

## 7. Quantity Discounts

Reference item #6.

## 8. Payment Terms

Net 30 days

## 9. Foreign Items

None

## 10. Time of Delivery

- a. 90 day ARO
- b. Expedited delivery: Items listed in the 10-Day section of the catalogs are available for expedited delivery.
- c. Overnight/2-day delivery: Select items may be available for overnight or 2-day delivery. Contact MillerKnoll Inc. or a participating dealer for availability and rates.
- d. Urgent requirements: Agencies may contact contractor or participating dealer to request faster delivery.

## 11. F.O.B.

F.O.B. destination except Alaska, Hawaii, and Puerto Rico, which will be shipped F.O.B. inland carrier point of exportation.

# Contract Information

continued

## 12. Ordering Address

- a. MillerKnoll Inc.  
Government Customer Care 0161  
855 East Main Avenue  
Zeeland MI 49464.
- b. For supplies and services, the ordering procedures information on Blanket Purchase Agreements (BPA's) are found in Federal Acquisition Regulation (FAR) 8.405-3.

## 13. Payment Address.

MillerKnoll Inc.  
22764 Network Place  
Chicago, IL 60673-1227

## 14. Warranty

MillerKnoll Inc. commercial warranty applies.

## 15. Export Packing Charge

Prices supplied on request.

## 16. Rental Maintenance and Repair Terms

Not applicable

## 17. Terms and Conditions of Installation/Reconfiguration and Relocation Services

\* Additional Notes for Installation & Reconfiguration and Relocation Services:

FOB Destination (Drop Ship): Price includes product delivery to the site, brought to the tailgate of the truck. The purchaser is responsible for unloading.

Prices effective up to the maximum order by SIN only. Above the MO, pricing shall be negotiated on a case-by-case basis between the client and local dealer.

Standard Services are Subject to the Following Conditions:

Installation will be performed during normal weekday working hours.

Adequate facilities for delivery, unloading, moving and staging/ storing the product during the installation process shall be provided.

Service work will not be hindered by other trades.

Electric, heat, and adequate elevator service will be furnished without charge.

The immediate installation area shall be complete and free of debris including the carpet/flooring before installation commences.

Any work requiring a licensed electrician is the responsibility of the buyer.

Additional Charges May Apply For:

Major Metro Markets and any non-ground floor installation.

Major Metro Markets include large population centers and urban environments.

Installation in a clinical/medical environment.

Special restrictions or limits established by local laws, ordinances or the directions of the buyer, including but not limited to restrictions on transportations of materials, street access to the job site and/or dock facilities.  
Installations outside of a 50 mile radius of the servicing dealer.  
Local Prevailing Wage and/or Union Labor Rates.  
Any additional charges shall be quoted by the dealer and approved by the buyer prior to performance of the work.

## 18. Terms and Conditions of Repair Parts

Not applicable

## 19. Service and Distribution Points

For service and distribution points nearest you, call (800) 851 1196.

## 20. Participating Dealers

Access Herman Miller web site for current list of participating dealers: [www.HermanMiller.com/where-to-buy/contact-a-dealer/](http://www.HermanMiller.com/where-to-buy/contact-a-dealer/). Select your market by using the filter.

## 21. Preventive Maintenance

Not applicable

## 22a. Special Attributes.

2022

MillerKnoll earns its 15th consecutive perfect score in Human Rights Campaign Foundation's 2022 Corporate Equality Index.

2021

The OE1 Trolley and Micro Packs are both winners of the 2021 Archiproducts international design competition in the Office Category.

MillerKnoll is named to Michigan's Best and Brightest in Wellness List for 2021.

MillerKnoll is awarded Platinum Rating in CSR by EcoVadis.

OE1 is named winner of Wallpaper's "Most Futuristic Furniture" Category as part of their first-ever Smart Space Awards.

OE1 receives the Workplace category award from Fast Company's 2021 Innovation by Design Awards.

MillerKnoll is named to Fast Company's Annual List of the World's Most Innovative Companies for 2021.

MillerKnoll is recognized as a "Disclosure Leader" by the Chemical Footprint Project (CFP).

MillerKnoll earns its 14th consecutive perfect score in Human Rights Campaign Foundation's 2021 Corporate Equality Index.

# Contract Information

*continued*

MillerKnoll is named to Newsweek's List of America's Most Responsible Companies 2021.

Great Lakes Women's Business Council awards MillerKnoll for "Excellence in Supplier Diversity" in the Best In Class category.

2020

Herman Miller is recognized with a 2020 FSC® Leadership Award for our commitment to responsible forestry management.

Herman Miller is named one of Investor's Business Daily Top 50 Best ESG (Environmental, Social, and Corporate Governance) Companies.

Working Mother names Herman Miller as one of the Best Companies for Dads.

Herman Miller is awarded Platinum Rating in CSR by EcoVadis.

Herman Miller is named Diversity Inc 2020 Noteworthy Company for recruitment efforts, employee development opportunities, leadership accountability, and supplier diversity.

Cosm, by Studio 7.5, receives an iF Gold Award in the Office and Industry category at the iF World Design Awards 2020.

Herman Miller earns its 13th consecutive perfect score in Human Rights Campaign Foundation's 2020 Corporate Equality Index.

2019

Mora System casework, designed by Collective Ten for Herman Miller, receives silver in the Industrial and Life Science Design/Medical Furniture category at the European Product Design Awards.

Mora System casework is awarded GOOD DESIGN Award 2019, selected for design excellence and innovation.

National Minority Supplier Diversity Council (NMSDC) names Herman Miller as the 2019 Class 1 Corporation of the Year for leadership in supplier diversity.

TIME Magazine names Cosm to its list of 100 Best Inventions of 2019.

Herman Miller is named #12 Overall and #2 in Manufacturing on Investor's Business Daily Best ESG (Environmental, Social, Governance) Companies.

Herman Miller is recognized as a silver level Certified Veteran-Friendly Employer by the Michigan Veterans Affairs Agency for a commitment to veteran hiring, retention, and development.

For the second year in a row, Herman Miller receives a Gold Medal from EcoVadis in recognition of Corporate Social Responsibility achievement measured in categories of environment, labor and human rights, ethics, and sustainable procurement.

Herman Miller is named "Frontrunner" in Chemical Footprint Project by Clean Production Action for our chemical management policies and practices.

Herman Miller receives International Interior Design Association and Contract's best showroom design award in the "Large Showroom" category at NeoCon.

Herman Miller earns its 12th consecutive perfect score in Human Rights Campaign Foundation's 2019 Corporate Equality Index.

Cosm, designed by Studio 7.5 for Herman Miller, receives a Red Dot Best of the Best Product Design Award in the "Office Chairs" category.

Lino, designed by Sam Hecht and Kim Colin for Herman Miller, receives an iF Design Award in the Product Design category.

2018

Overlay, designed by Birsell+Seck, receives Interior Design Best of Year Award in the Partitions and Wall Systems category.

Herman Miller receives the "Corporation of the Year" in consumer products award from the Michigan Minority Supplier Development Council.

Herman Miller achieves the Advanced Excellence in Supplier Diversity Award from the Great Lakes Women's Business Council for doing business with women-owned suppliers.

Great Lakes Women's Business Council awards Herman Miller for "Excellence in Supplier Diversity" in the Advanced category.

WEConnect awards Herman Miller an Honorable Mention for global supplier diversity initiatives.

As one of the top-scoring companies in the industry for the 14th consecutive year, Herman Miller has qualified for inclusion in RobecoSAM's 2018 Sustainability Yearbook and receives the Silver Class distinction for excellent sustainability performance—economic, environmental, and social.

For the 11th consecutive year, Herman Miller receives a perfect score on the Human Rights Campaign Foundation's Corporate Equality Index and is designated as Best Place to Work for LGBT equality. This report evaluates U.S. companies in terms of diversity, particularly LGBT-related policies and practices.

# Contract Information

*continued*

Herman Miller receives Gold Medal from EcoVadis in recognition of Corporate Social Sustainability achievement measured in categories of environment, labor and human rights, ethics, and sustainable procurement. EcoVadis operates the first web-based collaborative platform that allows companies to assess the environmental and social performance of their global suppliers.

Aeron receives Good Design Award from The Chicago Athenaeum Museum of Architecture and Design.

The Cosm Chair wins Mix Interiors “Product of the Year—Task” award.

2017

Herman Miller receives “Rising Star Award” from the Michigan Veterans Affairs Agency (MVAA) for exhibiting new and novel approaches to veteran recruitment and hiring.

Herman Miller is named the 2017 “Corporation of the Year” in the consumer products sector by the Michigan Minority Supplier Development Council (MMSDC).

Herman Miller receives a 2017 SEAL (Sustainability, Environmental Achievement and Leadership) Business Sustainability Award. SEAL Award winners are determined by a holistic methodology measuring applicants against established benchmarks that demonstrate impact and progress toward creating a healthy planet and a sustainable future.

Herman Miller earns the 4 Star Diversity Visionary Award. This award celebrates the diversity, equality, and inclusion work of Herman Miller. The award is presented at the annual Diversity Equity Inclusion Summit, held by the Grand Rapids Area Chamber of Commerce.

Herman Miller is named one of the Best and Brightest in Wellness for the 5th year in a row.

Herman Miller earns its 10th consecutive perfect score in Human Rights Campaign Foundation’s 2017 Corporate Equality Index.

As one of the top-scoring companies in the industry for the 13th consecutive year, Herman Miller has qualified for inclusion in RobecoSAM’s 2017 Sustainability Yearbook and receives the Bronze Class distinction for excellent economic, environmental, and social sustainability performance. The selection criteria for inclusion in the Yearbook becomes more rigorous each year, and only the top 15 percent of companies within each industry are selected.

Herman Miller once again earns the WorldatWork Seal of Distinction, a unique standard of excellence in work-life effectiveness that shows we provide a distinct, mutually beneficial workplace experience. Herman Miller is the only furniture manufacturer among the 160 companies across the U.S. and Canada honored with the award.

Herman Miller’s Mora wins Nightingale Silver Award in the “Furniture Collections” category at the 2017 Healthcare Design Conference.

2016

Herman Miller earns 9th consecutive perfect score in Human Rights Campaign Foundation’s Corporate Equality Index and is designated as Best Place to Work for LGBT equality.

Herman Miller is recognized as the Business of the Year at the Annual Meeting of the West Michigan Environmental Action Council (WMEAC) for being an outstanding partner in support of the growth of WMEAC’s programs. WMEAC’s award goes to the business with the greatest depth and breadth of support, unwavering dedication to environmental action in West Michigan, and a strong corporate commitment to environmental advocacy.

The 101 Best and Brightest Sustainable Companies once again (5th consecutive year) recognizes Herman Miller as an organization in Michigan (and for the first time, in the nation) that exhibits leadership and innovation in its approach to sustainability. This award celebrates those companies that are making their businesses more sustainable, the lives of their employees better, and the community, both locally and globally, more responsible as a whole.

Herman Miller is recognized by the Michigan Minority Supplier Development Council (MMSDC) as a “Corporation of the Year”. Additionally, we are the only West Michigan company this year to receive an “Ambassadors Championing Excellence” Award from the MMSDC.

Herman Miller is recognized with “2016 Excellence in Supplier Diversity Award” from the Great Lakes Women’s Business Council.

Herman Miller is recognized as a 2016 Healthiest 100 Workplace in America, ranking 49th in the country for our commitment to health and exceptional corporate wellness programming.

Herman Miller receives the Best and Brightest in Wellness Award for the 4th year in a row. This program is an innovative initiative that recognizes and celebrates quality and excellence in health awareness.

The Michigan Occupational Safety and Health Administration renews Herman Miller’s “Star” status, the highest workplace safety and health designation, for the Hickory facility in Spring Lake.

Plex Lounge Furniture from Herman Miller receives #MetropolisLikes award at NeoCon 2016.

Plex Lounge Furniture from Herman Miller receives Interior Design HIP Award for Workplace Seating/Lounge at NeoCon 2016.

Herman Miller is named a 2016 Women on Boards Winning Company. Companies selected for this recognition are considered champions of board diversity as 20 percent or more of their board seats are occupied by women.

Herman Miller is selected for inclusion in the 2016 RobecoSAM Sustainability Yearbook for the 12th consecutive year.

# Contract Information

*continued*

Herman Miller again earns the WorldatWork Work-Life 2016 Seal of Distinction. This award identifies organizations that focus on programs that promote work-life balance and overall well-being.

## **22b. Section 508 Compliance**

Not applicable

## **23. Unique Entity ID: Q2K3MSZ843D8**

## **24. Registered in System for Award Management (www.SAM.gov) Database**

## **25. Cancellation**

Prior to production, no cancellation charge will apply. After production, only actual cost incurred that the contractor can demonstrate if items are sold after 3 months.

## **26. Restocking Charges**

Agencies must notify the contractor for authorization prior to returning any items. The customer agency will be required to pay all packaging and return freight charges. A restocking fee of 50% for Systems Furniture and 35% for all other product lines will be charged for any returned items.

Returns and restocking policy is not applicable to Options products, products under SIN 337127, 339113H and Nemschoff products.

## **MillerKnoll Inc. Miscellaneous Information:**

Federal ID Number: 38-0837640

Commercial and Government Entity Code (CAGE): 40636

Data Universal Numbering System (DUNS) 00-601-2801

Commercial Entity Code (CEC): 00702290J



---

<b>Introduction</b>	<b>page 2</b>
<b>Embody® Chairs</b>	<b>3</b>
Work Chair	5
<b>Appendices</b>	
20-Day or Less/Assigned Lead-Time Order Information	
Casters and Glides	
Textiles Application Chart-Seating	
Textile Colors	
<b>For the latest materials information, refer to the Materials pages on <a href="http://HermanMiller.com">HermanMiller.com</a>.</b>	

---

# Introduction

## A Note on the Organization of This Book

There are a few signals that will help you understand the organization of this book. Once you know them, you should be able to find your way around easily.

### Like a newspaper, this book is formatted with columns of text and illustrations that run vertically.

Information wraps from one column to the next and continues for as many pages as it needs to.

### Black bars are clues.

A black bar at the top of a page signals the start of information about a product.

This information is divided into two sections, each signaled by a black bar. Product Information includes a description, additional notes, and dimensional drawings. Specification Information, which always begins at the top of a column, includes a series of steps. Each step represents a decision you need to make in order to complete your product number. Steps must be followed sequentially. The number of pages needed to complete information on a product varies; some will be complete in one page; others may fill three or four pages. Just continue going through the steps until you run into the next product, signaled by the black bar at the top of the page.

Black tabs running along the outside edge of the page help you locate what section you are in or what section you want to go to. You can thumb forwards or backwards to find a section; tabs and text appear on both sides of the page.

The additional pages in the back of the book include the appendices and indices. They are signaled by a long black bar running along the outside edge of the page.

### The index is presented two ways.

The first index is in alphabetical order by product name. It can be helpful if you are new to the products and numbering scheme or if you are looking for a type of product, such as work chair or round table.

The second index is by product number. It lists, in alphanumeric order, the base product number, typically a five-digit number.

## General Information

This book is effective January 30, 2023, subject to change without notice. Products may be purchased from authorized Herman Miller dealers who will quote prices upon request. For more information about our products and services or to see a list of dealers, visit [www.HermanMiller.com](http://www.HermanMiller.com).

All prices are list prices. Additional services, such as planning services, design, storage, and installation, are not included and must be added to these prices when the additional services are requested.

Illustrations, specifications, and prices are based on the latest information at the time of publication. The right is reserved to make changes at any time without notice in prices, fabrics, finishes, materials, specifications, and models, and also to discontinue models and finishes.

Dimensions shown in the drawings are engineering drawing dimensions rounded up to the nearest  $\frac{1}{8}$ ". Product is shipped set up or knocked down. Products that include "Shipped knocked down" in the description require some assembly. If this statement does not appear in the description, the product is shipped assembled.

Service problems are normally handled by a Herman Miller authorized dealer. Where this cannot be accomplished on a local level, service problems should be referred to the Customer Care Representative for your region, Herman Miller, Inc., Zeeland, Michigan 49464.

### 20-Day or Less/Assigned Lead-Time Shipments

All products and options in this price book not designated by an Assigned Program icon  will ship in **20 business days or less** after being acknowledged by Herman Miller.

Products and options designated by an  are on the assigned lead-time program and may ship in 20 days, less than 20 days, or more than 20 days from order acknowledgement.

**Work Chair**





# Work Chair

CN112  
CN122  
CN132



## Product Information

### Description

This chair has a pixelated seat and back that is textile-covered on the chair's front side. This construction provides support and comfort by spontaneously conforming to the user's shape and postural movements, while simultaneously moving heat away from the body. The Instinctive Back design mimics the human spine, providing passive support to the sacral, lumbar, and thoracic regions of the user's back, while the frameless, narrow back shape allows freedom of movement through the arms, neck and shoulders. The seat depth adjusts from 15" to 18" in 6 locking positions. The tilt supports the thoracic spine and stabilizes the pelvis through the deep, balanced recline. The tilt limiter allows the user to limit the amount of recline. The chair has a 5-star base and low-, standard-, or high-height range options.

Fully adjustable arms adjust 6" vertically and 6" horizontally.  
Textile on chair's front side is replaceable.

### Notes

For chairs with 3014, 3512, 3513, 21310, 1HA03, 1HA04, 1HA15, 1HA27, or 3SY12 textile color and graphite (G1) frame finish, the back mat is graphite. For all other options, the back mat is translucent.  
For information on casters, see Casters and Glides in Appendices.  
Customer's Own Material (COM) and Customer's Own Leather (COL) are not available on this chair.

MicrobeCare™ is an antimicrobial coating that can be applied to a wide variety of Herman Miller Group surfaces to protect products from mold, mildew, algae, and bacteria that cause deterioration, discoloration, odors, and stains.

MicrobeCare™ is a US Environmental Protection Agency (EPA) registered nonpublic health antimicrobial.

MicrobeCare™ is applied to the major touchpoints, including the seat, backrest, arms, armrests, frame and adjustment controls.

## Dimensions

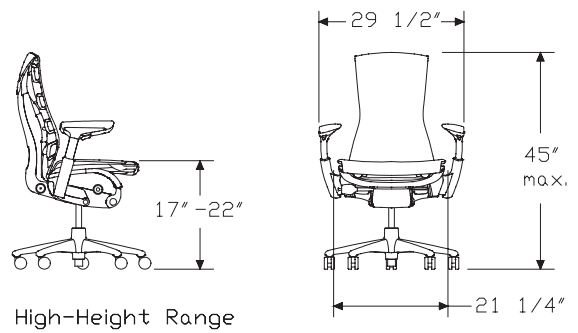
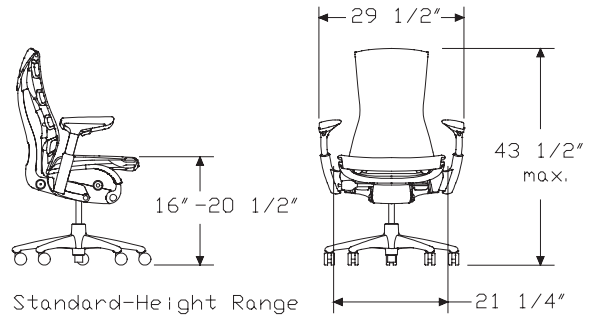
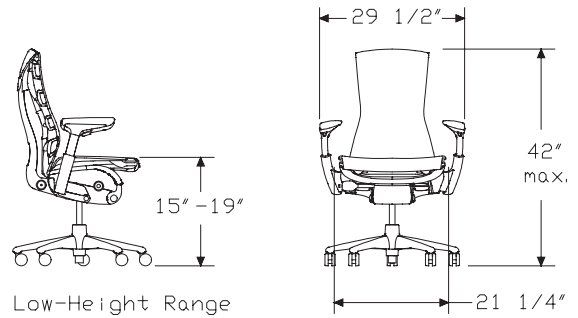

# Work Chair *continued*

## Specification Information

### Step 1.

**CN1**  A

### Step 2. Height Range

<b>12</b>	low-height range	+\$1899
<b>22</b>	standard-height range <input type="checkbox"/> A	+\$1899
<b>32</b>	high-height range	+\$1959

### Step 3. Arms

**AWAA** fully adjustable arms +\$213

### Step 4. Base Finish

<b>G1</b>	graphite	+\$0
<b>XT</b>	titanium	+\$40
<b>CD</b>	polished aluminum	+\$300

### Step 5. Frame Finish

<b>G1</b>	graphite <input type="checkbox"/> A	+\$0
<b>91</b>	white	+\$45
<b>MG1</b>	graphite with MicrobeCare™ <input type="checkbox"/> A	+\$70
<b>M91</b>	white with MicrobeCare™ <input type="checkbox"/> A	+\$115

### Step 6. Casters

<b>BB</b>	2½" hard caster, black yoke, carpet only <input type="checkbox"/> A	+\$0
<b>C7</b>	2½" caster, black yoke, hard floors or carpet	+\$50
<b>C9</b>	2½" braking caster, black yoke, hard floors or carpet	+\$50
<b>H9</b>	2½" translucent caster, hard floors or carpet	+\$70

### Step 7. Fabric

*See application chart and textiles list for fabric usage and numbers.  
First 2 digits of number indicate fabric line; remaining digit(s) indicate fabric color.*



Price Category 2	+\$72
Price Category 4	+\$147
Price Category 6	+\$363

# 20-Day or Less/Assigned Lead-Time Order Information

GSA

## 20-Day or Less and Assigned Lead-Time Programs

20-day or less and assigned lead-time products are designed for established Herman Miller dealers with pre-approved credit.

Products are distributed from multiple manufacturing facilities across the United States. All products and options not designated by an Assigned Lead-Time icon  will ship in 20 business days or less after being acknowledged by Herman Miller. Products and options designated by an  are on the assigned lead-time program and will ship in 20 days, less than 20 days, or more than 20 days from order acknowledgement.

## Ordering Procedure

Please place orders through Order Manager. If this is not available to you, place orders through mail or fax. Verbal purchase orders will not be accepted.

Order Entry fax number for Meridian® Filing and Storage:

(616) 846 9236.

Order Entry fax number for all other products:

(616) 654 3085.

For more information, contact your Customer Care representative at:

(866) 854 3048 ext 3400.

## Shipments and Delivery

Per Herman Miller Terms and Conditions.

## Changes and Cancellation

Per Herman Miller Terms and Conditions.





# Casters and Glides

## GSA

⚠	WARNING	⚠
Depending on the floor surface, chair may unexpectedly roll away from user when entering or exiting the chair, possibly leading to unexpected injury. Please refer to descriptions of floor types when selecting casters.		



**32 Caster**

1 7/8-inch-diameter hard double-wheel caster; black nylon wheels and yoke; for use on carpet only  
 Applicable on:  
 Sayl® Chairs

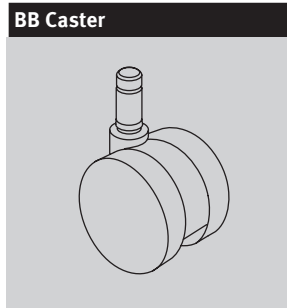

**BB Caster**

2 1/2-inch-diameter hard double-wheel caster; black nylon wheels and yoke; for use on carpet only  
 Applicable on:  
 New Aeron® Chairs  
 Capex® Chairs  
 Embody® Chairs  
 Fuld Nesting Chairs  
 Lino™ Chairs  
 Mirra® 2 Chairs  
 Sayl Chairs  
 Verus™ Chairs

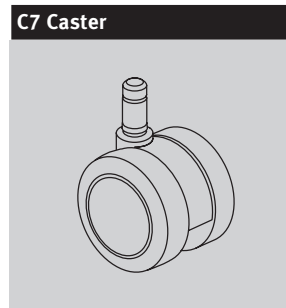

**C7 Caster**

2 1/2-inch-diameter double-wheel caster; black nylon wheels and yoke; soft polyurethane tread; for use on hard floors or carpet  
 Applicable on:  
 New Aeron Chairs  
 Capex Chairs  
 Embody Chairs  
 Fuld Nesting Chairs  
 Lino Chairs  
 Mirra 2 Chairs  
 Sayl Chairs      Verus Chairs

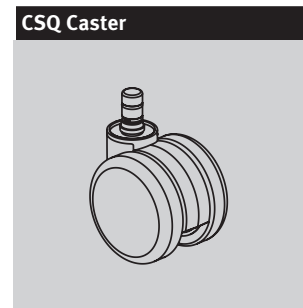

**CSQ Caster**

2 1/2-inch-diameter double-wheel caster; color-matched nylon wheels and yoke; soft polyurethane tread; for use on hard floors or carpet  
 Applicable on:  
 Zeph® Chairs

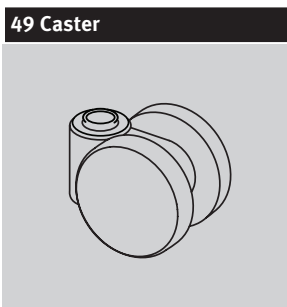

**49 Caster**

1 7/8-inch-diameter soft double-wheel caster; black nylon wheels and yoke; for use on hard floors or carpet  
 Applicable on:  
 Sayl Chairs



**BKS Caster**

2 1/2-inch-diameter hard double-wheel caster; black yoke; quiet roll technology; for use on carpet only  
 Applicable on:  
 Cosm™ Chairs

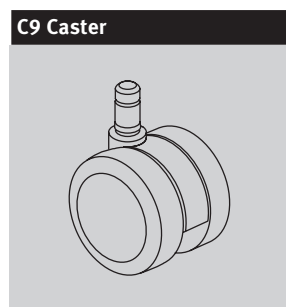

**C9 Caster**

2 1/2-inch-diameter double-wheel caster; black nylon wheels and yoke; soft polyurethane tread; internal brake; for use on hard floors or carpet  
 Applicable on:  
 Capex Chairs  
 Embody Chairs  
 Lino Chairs  
 Mirra 2 Chairs  
 Sayl Chairs  
 Setu Chairs      Verus Chairs

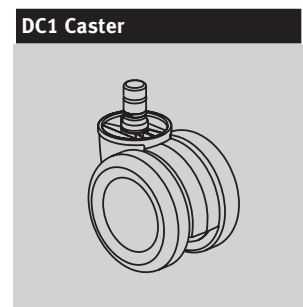

**DC1 Caster**

2 1/2-inch-diameter double-wheel braking caster; black nylon wheels and yoke; for use on hard floors or carpet; quiet roll technology  
 Applicable on:  
 New Aeron Chairs

# Casters and Glides

continued

## GSA

Appendix: Casters and Glides

**DS Caster**

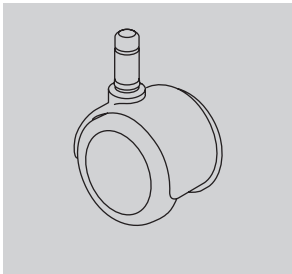

2-inch-diameter soft double-wheel braking caster; black nylon wheels and hood; for use on hard floors only

Applicable on:

Aside® Chairs  
Caper Chairs

**HCC Caster**

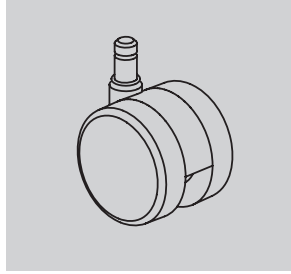

2<sup>1</sup>/<sub>2</sub>-inch-diameter double-wheel low roll resistance caster; black yoke; for use on hard floors or carpet.

Applicable on:

Setu Chairs

**SC8 Caster**

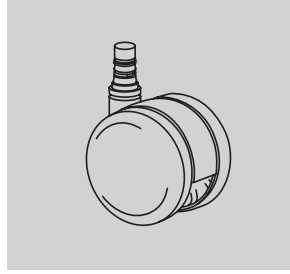

2<sup>1</sup>/<sub>2</sub>-inch-diameter double-wheel caster; black nylon wheels and yoke; soft polyurethane tread; quiet roll technology; for use on hard floors or carpet

Applicable on:

Cosm Chairs  
Fuld Nesting Chairs  
Lino Chairs  
Mirra 2 Chairs  
Verus Chairs

**U5 Caster**

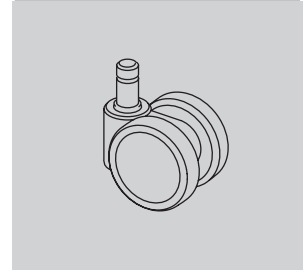

1<sup>7</sup>/<sub>8</sub>-inch-diameter soft double-wheel caster; black nylon wheels and yoke; for use on hard floors or carpet

Applicable on:

Aside Chairs  
Caper Chairs  
Verus Chairs

**H9 Caster**

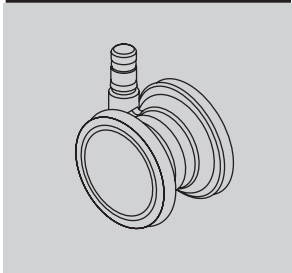

2<sup>1</sup>/<sub>2</sub>-inch-diameter double-wheel caster; clear polycarbonate wheels; nylon yoke; soft polyurethane tread; for use on carpet only.

Applicable on:

Embody Chairs

**OC Caster**

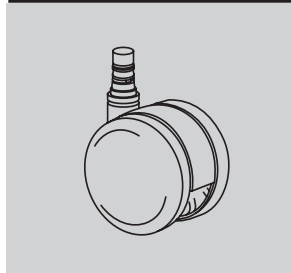

2<sup>1</sup>/<sub>2</sub>-inch-diameter double-wheel medium roll-resistant caster; black nylon wheels and yoke; soft polyurethane tread; for use on hard floors or carpet; quiet roll technology

Applicable on:

Cosm Chairs  
Fuld Nesting Chairs  
Setu Chairs

**U4 Caster**

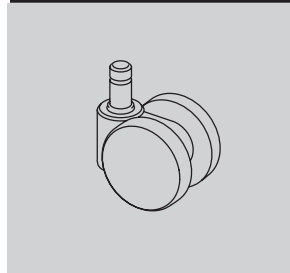

1<sup>7</sup>/<sub>8</sub>-inch-diameter hard double-wheel caster; black nylon wheels and yoke; for use on carpet only

Applicable on:

Aside Chairs  
Verus Chairs

**16 Glide**

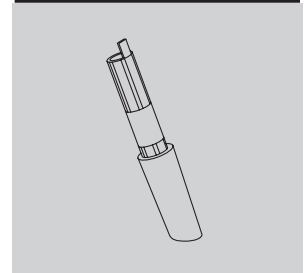

(Front glide shown)

2<sup>1</sup>/<sub>8</sub>-inch-high glide; black or fog acetal; for use on carpet only

Applicable on:

Sayl Chairs

# Casters and Glides

continued

## GSA

**69 Glide**

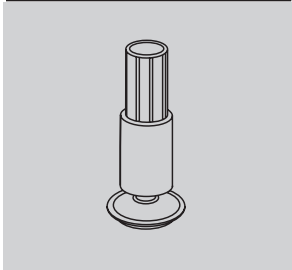

(Front glide shown)  
2<sup>1</sup>/<sub>8</sub>-inch-high glide; black glass-filled nylon stem; steel-plated swivel foot with Floor Saver Glide® insert; for use on hard floors only  
Applicable on:  
Sayl Chairs

**GF Glide**

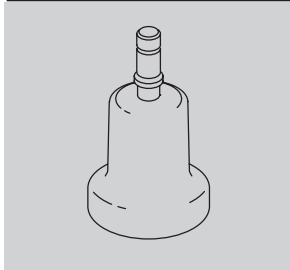

2<sup>1</sup>/<sub>2</sub>-inch-high glide; black nylon; for use on hard floors or carpet  
Applicable on:  
New Aeron Chairs  
Caper Chairs  
Cosm Chairs  
Lino Chairs  
Mirra 2 Chairs  
Sayl Chairs  
Verus Chairs

**GLN Glide**

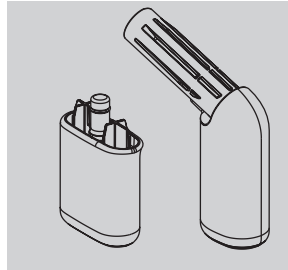

Acetal glide; for use on carpet only  
Applicable on:  
Fuld Nesting Chairs

**SG Glide (for Aside)**

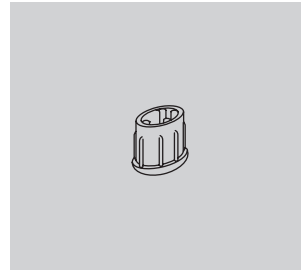

1/2-inch-high glide; black nylon; for use on carpet only  
Applicable on:  
Aside Chairs

**G4 Glide**

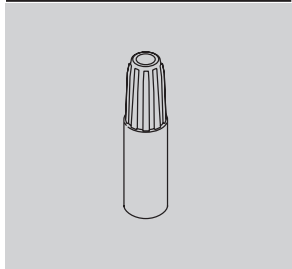

1<sup>7</sup>/<sub>8</sub>-inch-high glide; black acetal; for use on carpet only  
Applicable on:  
Verus Chairs

**GL Glide**

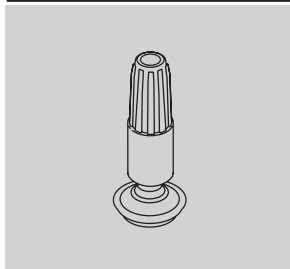

1<sup>7</sup>/<sub>8</sub>-inch-high glide; black nylon stem; steel-plated swivel foot with Floor Saver Glide® insert; for use on hard floors only  
Applicable on:  
Verus Chairs

**HG Glide**



1/2-inch-high glide; black nylon glide with stainless-steel insert; for use on hard floors or carpet  
Applicable on:  
Aside Chairs

**X8 Glide**

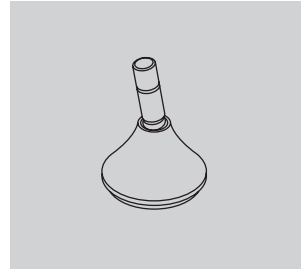

Glide; low profile; for use on hard floors or carpet  
Applicable on:  
Setu Chairs

# Casters and Glides

continued

## GSA

### XS Glide

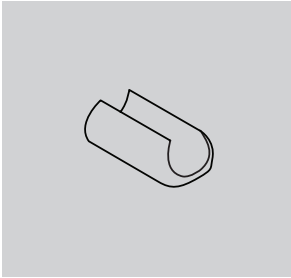

1/8-inch-high glide; polycarbonate in black, fog, clear, and studio white finishes; for use on hard floors or carpet

Applicable on:  
Sayl Chairs

### YX Glide

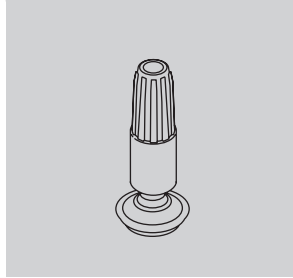

1 7/8-inch-high glide; black nylon stem; steel-plated swivel foot with Floor Saver Glide® insert; for use on hard floors only

Applicable on:  
Caper Chairs

### Y7 Glide

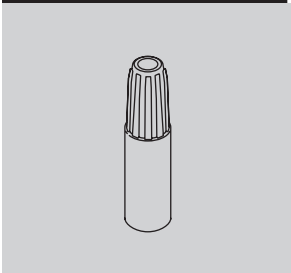

1 7/8-inch-high glide; black acetal; for use on carpet only

Applicable on:  
Caper Chairs

# Textiles Application Chart — Seating

## GSA

• Available

[A] Assigned lead-time textile.

[A] Maharam textiles are on assigned lead times.

See following page for exception notes.

[N] Non-woven textile.

	Aeron® Chairs	Cosm™ Chairs	Mirra® 2 Chairs/Stools	Embody® Chairs	Fuld Nesting Chairs	Sayl® Work Chairs/Stools	Sayl Side Chairs	Setu® Chairs/Stools	Zeph® Chairs	Verus™ Work Chairs/Stools Back	Verus Work Chairs/Stools Seat	Verus Side Chairs Back	Verus Side Chairs Seat	Verus Plus Chairs	Aside® Chairs	Caper® Chairs/Stools	Lino™ Chairs Back	Lino Chairs Seat	OE1 Storage Trolley Cushion Top	Public® Office Landscape Back	Public Office Landscape Seat	Plex™ Lounge Furniture	Swoop™ Lounge Seating - Fully Upholstered	Swoop Lounge Seating - Plywood	Valor™ Seating	Cushion Tops	Workspaces	
<b>Price Category 1</b>																												
COM Customer's Own Material [A]						1	1			1	1	1	1	1	1			1	1		1	1	1	1	1	1	1	1
231__ 8Z Pellicle®	•																											
1A7__ AireWeave 2			•																									
8T__ Crossing								•							•				•									
3DE__ Dex						•	•	•		•	•	•	•	•	•				•									
4RM__ Duo																	•				•	19	•		•	•	•	•
6V__ Flexnet™																•												
845__ Intercept		•																										
4W__ Lyris 2™								•																				
1MN__ Monologue						25	23	•		•	•	•						•	•		•	•	•	•	•	•	•	•
5H2__ Ripple 3D Knit									•																			
4SC__ Scatter						•	•	•		•	•	•	•	•	•			•	•		•	•	•	•		•	•	•
5H1__ Splash 3D Knit									•									•	•		•	•	•	•		•	•	•
3DK__ Stretch Knit						22																						
235__ Tailored						•	•	•		•	•	•	•	•	•			•			•	24		•	7	•	•	•
9NK__ Tuck 3D Knit					•																							
1WS__ Whisper						25	•	•		•	•	•	•	•	•			•	•		•	•	•	•	•	•	•	•
<b>Price Category 2</b>																												
3AR__ Aristo						•	•	•		•	•	•	•	•	•			•	•		•	•	•	•	•	•	•	•
92__ Crepe						•	•	•		•	•	•	•	•	•			•	•		•	•	•	•	•	•	•	•
3EP__ Epic						•	•			•	•	•	•	•	•			•	•		•	•	•	•	•	•	•	•
3DP__ Hint						•	•			•	•	•	•	•	•			•	•		•	•	•	•	•	•	•	•
1MV__ Marvel [N]						22	23	•										•										
1HA__ Medley			•			•	23			•	•	•	•	•	•			•	•		•	•	•	•	•	•	•	•
4ME__ Mellow						•	23	•		•	•	•	•	•	•			•	•		•	•	•	•	•	•	•	•
ZMA__ Metaphor - Maharam [A]						16	16	•		•	•	•	•	•	•			•	•		•	•	•	•	•	•	•	•
8I1__ Muse - Maharam [A]						16	16			•	•	•	•	•	•			•	•		•	•	•	•	•	•	•	•
30__ Rhythm						24	•	•		•	•	•	•	•	•			•	•		•	•	•	•	•	•	•	•
3SL__ Sequel [N]						•	•	•		•	•	•	•	•	•	8		•	•		•	•	•	•	•	•	•	•
4TE__ Terra						•	23			•	•	•	•	•	•			•	•		•	•	•	•	•	•	•	•
8R__ Twist						•	•	•		•	•	•	•	•	•			•	•		•	•	•	•	•	•	•	•
<b>Price Category 3</b>																												
3AC__ Ace						22	•			•	•	•	•	•	8			•	•		•	19		•	•	•	•	•
43Z__ Fractal						•	•	•		•	•	•	•	•	•			•				•	•	•	•	•	•	•
8M__ Latitude™						24																						
4GE__ Parcel						•	•	•		•	•	•	•	•	•			•				•	•	•	•	•	•	•
<b>Price Category 4</b>																												
3DM__ Daydream						22	•	•		•	•	•	•	•	•			•	•		•	•	•	•	•	•	•	•
3SY__ Sync						•	•	•		•	•	•	•	•	•			•			•	•	•	•	•	•	•	•
<b>Price Category 5</b>																												
3CY__ Cozy						•	•	•		•	•	•	•	•	•			•			•	•	•	•	•	•	•	•
14A__ Hopsak						•	•	•		•	•	•	•	•	•			•	•		•	•	•	•	•	•	•	•
40G__ Method - Maharam [A]						16	16	•		•	•	•	•	•	•			•	•		•	•	•	•	•	•	•	•
ZNC__ Nico - Maharam [A]						•	•			•	•	•	•	•	•			•			•	•	•	•	•	•	•	•
3SU__ Summit						•	•	•		•	•	•	•	•	•			•			•	•	•	•	•	•	•	•

Continued on next page

# Textiles Application Chart — Seating

## GSA continued

• Available

[A] Assigned lead-time textile.

[A] Maharam textiles are on assigned lead times.

See following page for exception notes.

[N] Non-woven textile.

	Aeron® Chairs	Cosm™ Chairs	Mirra® 2 Chairs/Stools	Embody® Chairs	Fuld Nesting Chairs	Sayl® Work Chairs/Stools	Sayl Side Chairs	Setu® Chairs/Stools	Zeph® Chairs	Verus™ Work Chairs/Stools Back	Verus Work Chairs/Stools Seat	Verus Side Chairs Back	Verus Side Chairs Seat	Verus Plus Chairs	Aside® Chairs	Caper® Chairs/Stools	Lino™ Chairs Back	Lino Chairs Seat	OE1 Storage Trolley Cushion Top	Public® Office Landscape Back	Public Office Landscape Seat	Plex™ Lounge Furniture	Swoop™ Lounge Seating - Fully Upholstered	Swoop Lounge Seating - Plywood	Valor™ Seating	Cushion Tops	Workspaces
<b>Price Category 6</b>																											
35__ Balance				•																							
<b>Price Category 7</b>																											
COL Customer's Own Leather [A]	1														8				1								1
<b>Price Category 8</b>																											
No fabrics available at this time																											
<b>Price Category 9</b>																											
ZGE__ Gemma - Maharam [A]						•	•	•		•	•	•	•	•	•			•			•	•	•	•	•	•	•
ZJA__ Jasper - Maharam [A]						16	16				•		•	•	•			•			•					•	7
21__ Leather [N]	24														8			•	•						•	•	
<b>Price Category 10</b>																											
3KH__ Firma - Maharam [A]						16		•		•	•	•	•	•	•			•			•	•	•	•	•	•	•
ZGF__ Gemma Multi - Maharam [A]								•	•	•		•	•	•	•			•			•	•	•	•	•	•	•
ZGF__ Gemma Multi Reverse - Maharam [A]								•	•	•		•	•	•	•			•			•	•	•	•	•	•	•
ZP4__ Petra - Maharam [A]						16	16				•		•	•	•			•			•	•	•	•	•	•	•
<b>Price Category A</b>																											
No fabrics available at this time.																											
<b>Price Category B</b>																											
TI__ Messenger - Maharam [A] *								•	•	•		•	•	•	•			•	•			•	•	•	•	26	•
<b>Price Category C</b>																											
Z27__ Manner - Maharam [A]								•	•			•		•				•	•			•	•	•	•	•	•
887__ Merit - Maharam [A]								•	•			•	•	•	•			•	•			•	•	•	•	•	•
Z3__ Metric - Maharam [A]								•	•			•	•	•	•			•	•			•	•	•	•	•	•
8EY__ Murmur - Maharam [A]								•	16			•		•				•			•	•	•		•	7	
<b>Price Category D</b>																											
8I8__ Bluff - Maharam [N] [A]						16	16			•	•	•	•	•	8						•	21		•	•	•	
<b>Price Category E</b>																											
No fabrics available at this time.																											
<b>Price Category F</b>																											
82T__ Apt [N] - Maharam [A]						18	•				•	•								•	•			•	7		
74M__ Instill [N] - Maharam [A]						18	16			•	•	•	•					•			•	•		•	•	7	
89N__ Keen - Maharam [A]						16	16				•	•	•	•				•			•	•	•	•			
V9G__ Ledger - Maharam [A]						18	16			•	•	•	•					•	•						•	•	
ZLL__ Loop - Maharam [A]						16	16				•	•			8			•			•				•		
8LW__ Pepper - Maharam [A]						16	16				•	•						•			•	21	•		9		
Z33__ Strum - Maharam [N] [A]							16																•		•	7	

Continued on next page

\* Available in select colors on 20-day lead-time. Refer to "Textile Colors" for 20-day colors.

# Textiles Application Chart — Seating

GSA continued

• Available

[A] Assigned lead-time textile.

[A] Maharam textiles are on assigned lead times.

See following page for exception notes.

[N] Non-woven textile.

	Aeron® Chairs	Cosm™ Chairs	Mirra® 2 Chairs/Stools	Embody® Chairs	Fuld Nesting Chairs	Sayl® Work Chairs/Stools	Sayl Side Chairs	Setu® Chairs/Stools	Zeph® Chairs	Verus™ Work Chairs/Stools Back	Verus Work Chairs/Stools Seat	Verus Side Chairs Back	Verus Side Chairs Seat	Verus Plus Chairs	Aside® Chairs	Caper® Chairs/Stools	Lino™ Chairs Back	Lino Chairs Seat	OE1 Storage Trolley Cushion Top	Public® Office Landscape Back	Public Office Landscape Seat	Plex™ Lounge Furniture	Swoop™ Lounge Seating - Fully Upholstered	Swoop Lounge Seating - Plywood	Valor™ Seating	Cushion Tops	Workspaces
<b>Price Category G</b>																											
ZC2__ Compound - Maharam [N] [A]						16	16			•	•	•	•		8			•				•	•	•	•	7	
8AR__ Gild - Maharam [A]							16				•	•	•	•							•	21	•	•	•		
<b>Price Category H</b>																											
ZT__ Circles - Maharam [A]						16	16																				•
ZK__ Dot Pattern - Maharam [A]						•	•	•		•		•			•				•						•	•	
ZL__ Small Dot Pattern - Maharam [A]						•	•	•		•		•			•				•						•	•	
<b>Price Category I</b>																											
7CW__ Cursive - Maharam [A]						16	16			•	•	•	•		8			•	•		•		•	•	•	•	
<b>Price Category J-V</b>																											
No fabrics available at this time.																											

*Application Note: Herman Miller cannot guarantee material/pattern alignment in adjacent products. For example, a fabric's pattern may not align from one pedestal cushion top to the next, or from one chair to another.*

- |  |  |
|--|--|
| 1 Refer to price book appendices and Omni for COM/COL information. | 21 Available on Plex seat and on ottoman.                                    |
| 7 Available on 1" Cushion Tops only.                               | 22 Not available on Sayl upholstered back work chairs.                       |
| 8 Only available on Aside non-upholstered outer back (PB) option.  | 23 Not available on Sayl side chairs with upholstered backs.                 |
| 9 Available on Valor upholstered seat only.                        | 24 Available in select colors. Refer to "Textile Colors" for color offering. |
| 16 Available on Sayl Chair seat.                                   | 25 Not available on Sayl upholstered High-Back Work Chairs.                  |
| 18 Available on Sayl Chair seat and upholstered mid-back.          | 26 Available in select colors. Refer to "Textile Colors" for color offering. |
| 19 Available on Plex seat only.                                    |  |
| 20 Not available on Plex Club Chair with Headrest.                 |  |





# Textile Colors

## GSA

### Price Category 1

**Customer's Own Material**  
Seating  
See Order Information in  
Appendices.  
Assigned lead-time textile. A

**8Z Pellicle®**  
Seating  
For New Aeron® Chairs  
56% elastomeric  
44% polyester  
23101 Mineral  
23102 Carbon  
23103 Graphite

**AireWeave™ 2**  
Seating  
For Mirra® 2 Chairs  
67% elastomeric  
33% antimony-free polyester  
1A701 Alpine  
1A702 Slate Grey  
1A703 Graphite  
1A704 Lime Green  
1A705 Cappuccino  
1A706 Urban Orange  
1A707 Dark Turquoise  
1A708 Twilight

**Chain**  
Workspaces  
66" wide  
100% recycled polyester  
with 12% ocean bound plastic  
2V01 Pearl  
2V02 Oyster  
2V03 Wheat  
2V04 Linen  
2V05 Wicker  
2V06 Bamboo  
2V07 Sage  
2V08 Spring Wood  
2V09 Iceberg

**Crossing**  
Seating/Workspaces  
54" wide  
86% antimony-free polyester  
14% polyester  
8T03 Wicker \*  
8T04 Porcelain \*  
8T05 Warm Grey \*  
8T10 Tomato  
8T17 Cerulean  
8T18 Indigo  
8T19 Shale \*  
8T22 Tin \*  
8T23 Graphite  
8T24 Black

**Crossing**  
Workspaces  
For systems products only.  
54" wide  
86% antimony-free polyester  
14% polyester  
8501 Ivory \*  
8502 Oyster \*

\* Crossing colors available  
on Exclave® Video-friendly  
Tackable Boards and Stowage  
Tackable Backdrop

**Dex**  
Seating/Workspaces  
54" wide  
67% recycled polyester  
33% polyester  
3DE01 Frost  
3DE02 Silver Pine  
3DE03 Stone  
3DE04 Shale  
3DE05 Charcoal  
3DE06 Gossamer  
3DE07 Pine

**Duo**  
Seating  
For Lino™ Chairs  
52% polyester  
48% elastomeric  
4RM01 Mineral  
4RM02 Poppy  
4RM03 Green Leaf  
4RM04 Jade  
4RM05 Shadow  
4RM06 Graphite

**Flexnet™**  
Seating  
For Caper® Chairs  
69% elastomeric  
31% polyester  
6V01 Black  
6V02 Silver Grey

**Grasscloth**  
Workspaces  
66" wide  
100% recycled polyester  
with 11% ocean bound plastic  
2I01 Silver Birch  
2I02 Pampas  
2I03 Sedge  
2I07 Lea  
2I08 Taro  
2I09 Steam Grey  
2I13 Gravel

**Intercept**  
Seating  
For Cosm™ Chairs  
60% elastomeric  
40% polyester  
84501 Graphite  
84502 Carbon  
84503 Mineral  
84504 Nightfall  
84505 Glacier  
84506 Canyon

**Lyris 2™**  
Seating  
For Setu® Chairs  
74% elastomeric  
26% polyester  
4W21 Alpine  
4W23 Chartreuse  
4W25 Berry Blue  
4W26 Slate Grey  
4W28 Chino  
4W31 Graphite

**Monologue**  
Seating/Workspaces  
54" wide  
56% recycled polyester  
44% polyester  
1MN01 Linen  
1MN02 Alabaster  
1MN04 Folkstone  
1MN05 Silver Pine  
1MN06 Slate  
1MN07 Seed  
1MN09 Persimmon  
1MN11 Meadow  
1MN12 Blue Sky  
1MN13 Blue Spruce  
1MN14 Deep Sea

Price category 1 continued on  
next page

# Textile Colors

continued

GSA

## Price Category 1

continued

Appendix: Textile Colors

Resonance	
Workspaces	
66" wide	
100% polyester	
5T04	Greige
5T05	Porcelain
5T06	Alabaster
5T15	Iris
5T28	Sugar
5T47	Tobacco
5T54	Saltbush
5T57	Seed
5T58	Sepia
5T60	Iceberg
5T65	Red
5T67	Boysenberry
5T68	Pistachio
5T69	Green Apple
5T71	Jade
5T72	Blue Green
5T74	Twilight

Ripple 3D Knit	
Seating	
Available only on Zeph® Chairs.	
knit to size	
99% recycled polyester	
1% lycra	
5H201	Black
5H202	Carbon
5H203	Alpine
5H204	Silt
5H205	Tea Rose
5H206	Cocoa
5H207	Persimmon
5H208	Blaze
5H209	Cayenne
5H210	Falcon
5H211	Mustard Seed
5H212	Patina
5H213	Olive
5H214	Moss
5H215	Aloe
5H216	Glacier
5H217	Ultramarine
5H218	Nightfall
5H219	Bluebell
5H220	Boysenberry
5H221	Nightfall/Bluebell
5H222	Patina/Alpine
5H223	Cayenne/Glacier
5H224	Tea Rose/Olive
5H225	Silt/Blaze

Scatter	
Seating/Workspaces	
54" wide	
100% recycled polyester,	
with 26% ocean bound plastic	
4SC01	Alpine
4SC02	Fog
4SC03	Shale
4SC04	Persimmon
4SC07	Olive
4SC08	Glacier
4SC09	Blue Sky
4SC10	Lagoon
4SC11	Slate Grey
4SC12	Blue Black

Slant	
Workspaces	
66" wide	
51% polyester	
49% recycled polyester	
22F04	Pesto
22F06	Neptune
22F07	Blueberry
22F10	Pumpkin
22F12	Silver Birch
22F13	Bluestone
22F15	Shale

Splash 3D Knit	
Seating	
Available only on Zeph® Chairs.	
knit to size	
98% recycled polyester	
2% lycra	
5H101	Black
5H102	Carbon
5H103	Alpine
5H104	Silt
5H105	Tea Rose
5H106	Cocoa
5H107	Persimmon
5H108	Blaze
5H109	Cayenne
5H110	Falcon
5H111	Mustard Seed
5H112	Patina
5H113	Olive
5H114	Moss
5H115	Aloe
5H116	Glacier
5H117	Ultramarine
5H118	Nightfall
5H119	Bluebell
5H120	Boysenberry

Stretch Knit	
Seating	
Assigned lead-time textile. <span style="border: 1px solid black; padding: 0 2px;">A</span>	
Available only on Sayl®	
Suspension Back Work Chairs	
97% polyester, 3% spandex	
3DK01	Fog
3DK02	Slate Grey
3DK03	Java
3DK04	Black
3DK05	Red
3DK06	Green Apple
3DK07	Berry Blue

Price category 1 continued on next page

# Textile Colors

continued

## GSA

### Price Category 1

continued

Tailored	
Seating/Workspaces	
54" wide	
56% polyester	
44% recycled polyester	
23501	Studio White * **
23502	Sugar **
23503	Tomato
23506	Chive
23508	Cobalt
23509	Cadet
23510	Fog
23511	Graphite
23512	Black
23513	Coffee

\* Color not available on Canvas Tiles.

\*\* Colors not available on Plex™ Lounge Furniture.

Tuck 3D Knit	
Seating	
Available only on Fuld Nesting Chairs.	
knit to size	
56% polyester	
44% recycled polyester	
9NK01	Alpine
9NK02	Carbon
9NK03	Nightfall
9NK04	Olive
9NK05	Cocoa
9NK06	Canyon

Whisper	
Seating/Workspaces	
54" wide	
73% recycled polyester	
27% polyester, with 11.3% ocean bound plastic	
1WS01	Sand Dollar
1WS02	Pebble
1WS03	Silver Birch
1WS04	Iceberg
1WS05	Silver Pine
1WS06	Carbon
1WS07	Cumin
1WS12	Willow
1WS13	Sea Grass
1WS14	Pool
1WS15	Blueberry

### Price Category 2

Aristo	
Seating/Workspaces	
54" wide	
88% recycled polyester	
12% polyester	
Acrylic backing	
3AR01	Forest Moss
3AR02	Light Brindle
3AR03	Mink
3AR04	Copper
3AR05	Adobe
3AR06	Cherry
3AR07	Lilac
3AR08	Green Apple
3AR09	Surf
3AR10	Waterfall
3AR11	Cadet
3AR12	Tin
3AR13	Pewter
3AR14	Grey Brindle
3AR15	Grey Black

Crepe	
Seating/Workspaces	
54" wide	
100% recycled polyester, with 43.6% ocean bound plastic	
9201	Licorice
9203	Smoke
9207	Cherry
9223	Cadet
9241	Beachglass
9249	Stone *
9251	Fog *
9252	Slate Grey
9261	Shale
9262	Graphite
9265	Mineral
9266	Persimmon
9267	Juniper
9268	Glacier
9269	Cascade
9270	Navy

\* Colors available on Exclave® Video-friendly Tackable Boards and Stowage Tackable Backdrop

Epic	
Seating/Workspaces	
54" wide	
56% recycled polyester	
44% polyester	
Acrylic backing	
3EP01	Alabaster
3EP02	Smoke
3EP03	Falcon
3EP05	Copper
3EP06	Urban Orange
3EP07	Poppy
3EP10	Clover
3EP11	Loden
3EP14	Peacock
3EP15	Cadet
3EP16	Indigo
3EP17	Spring Wood
3EP18	Grey Brindle
3EP19	Seed
3EP20	Carbon Dark

Hint	
Seating/Workspaces	
54" wide	
76% recycled polyester	
24% polyester	
3DP01	Sediment
3DP02	Gunmetal
3DP03	Silt
3DP04	Porcelain
3DP05	Indigo
3DP06	Fern
3DP07	Adobe
3DP08	Red Sea

Price category 2 continued on next page

# Textile Colors

continued

GSA

## Price Category 2

continued

Appendix: Textile Colors

Horizon	
Workspaces	
54" wide	
65% antimony-free polyester	
35% polyester	
4N01	Rye Grass
4N02	Sugar Pine
4N03	Silver Pine
4N04	White Ash
4N05	Spring Wood
4N08	Haystack
4N09	Oat Grass
4N13	Pine Cone
4N15	Elderberry

Marvel	
Seating	
54" wide	
100% pvc-free polyurethane	
1MV01	Summer White
1MV02	Sand Dollar
1MV03	Espresso
1MV04	Folkstone Grey
1MV05	Graphite
1MV06	Onyx
1MV07	Polar Blue
1MV08	Blush Grey
1MV12	Red
1MV14	Pine
1MV15	Teal Green
1MV16	Twilight

Medley	
Seating/Workspaces	
54" wide	
100% polyester	
1HA01	Stone *
1HA02	Trail
1HA03	Charcoal
1HA04	Cinder
1HA07	Chutney
1HA09	Feather Grey *
1HA11	Loden
1HA13	Bayou *
1HA14	Blue Grotto
1HA15	Blueberry
1HA22	Khaki
1HA23	Pewter

\* Colors available on Exclave®  
Video-friendly Tackable Boards  
and Stowage Tackable Backdrop

Mellow	
Seating/Workspaces	
54" wide	
100% recycled polyester, with 16% ocean bound plastic	
4ME01	Mineral
4ME04	Olive
4ME05	Glacier
4ME06	Oceanside
4ME07	Charcoal

Metaphor – Maharam	
Seating/Workspaces	
54" wide	
100% polyester	
Acrylic backing	
ZMA01/466553-001	Afterfeather
ZMA02/466553-002	Moonflower
ZMA03/466553-003	Handcraft
ZMA04/466553-004	Crossroad
ZMA05/466553-005	Chondrite
ZMA06/466553-006	Detective
ZMA07/466553-007	Steamship
ZMA08/466553-008	Electricity
ZMA09/466553-009	Takeoff
ZMA10/466553-010	Parachute
ZMA11/466553-011	Blueshift
ZMA12/466553-012	Dockyard
ZMA13/466553-013	Bathe
ZMA14/466553-014	Icebound
ZMA15/466553-015	Thermosphere
ZMA16/466553-016	Aboard
ZMA17/466553-017	Agateware
ZMA18/466553-018	Homeland
ZMA19/466553-019	Rockfall
ZMA20/466553-020	Undergrowth
ZMA21/466553-021	Gremolata
ZMA22/466553-022	Patina
ZMA23/466553-023	Sylvan
ZMA24/466553-024	Outfield
ZMA25/466553-025	Windbreak
ZMA26/466553-026	Saguaro
ZMA27/466553-027	Barnwood
ZMA28/466553-028	Cookshop
ZMA29/466553-029	Amandine
ZMA30/466553-030	Bodhran
ZMA31/466553-031	Centerstage
ZMA32/466553-032	Focaccia
ZMA33/466553-033	Bumblebee
ZMA34/466553-034	Microbrew
ZMA35/466553-035	Sauna
ZMA36/466553-036	Gazebo
ZMA37/466553-037	Pirouette
ZMA38/466553-038	Heartbeat
ZMA39/466553-039	Shino
ZMA40/466553-040	Sunrise

Metaphor continued	
ZMA41/466553-041	Florist
ZMA42/466553-042	Beadwork
ZMA43/466553-043	Framboise
ZMA44/466553-044	Wisteria
ZMA45/466553-045	Warrior

Muse – Maharam	
Seating/Workspaces	
54" wide	
100% post-consumer recycled polyester	
8I101/466487-001	Crescendo
8I102/466487-002	Resonate
8I103/466487-003	Runway
8I104/466487-004	Ascend
8I105/466487-005	Veil
8I106/466487-006	Refresh
8I107/466487-007	Clear
8I108/466487-008	Fantasy
8I109/466487-009	Miso
8I110/466487-010	Compass
8I111/466487-011	Bergamot
8I112/466487-012	Grasshopper
8I113/466487-013	Goal
8I114/466487-014	Mistletoe
8I115/466487-015	Seaglass
8I116/466487-016	Frigid
8I117/466487-017	Riverbend
8I118/466487-018	Noble
8I119/466487-019	Pulsar
8I120/466487-020	Velella
8I121/466487-021	Sailboat
8I122/466487-022	Sparse
8I123/466487-023	Vase
8I124/466487-024	Haven
8I125/466487-025	Mead
8I126/466487-026	Neat
8I127/466487-027	Jovial
8I128/466487-028	Theater
8I129/466487-029	Poinsettia
8I130/466487-030	Celebrate
8I131/466487-031	Spectacle

Price category 2 continued on next page

# Textile Colors

continued

## GSA

### Price Category 2

continued

#### Rhythm

Seating	
54" wide	
100% polyester	
3002	Green Apple
3004	Bayou
3005	Berry Blue
3006	Iris
3007	Twilight
3009	Poppy
3010	Molasses
3012	Khaki
3013	Mink
3014	Black *
3015	Charcoal *

\* Colors available on Embody® Chair

#### Sequel

Seating/Workspaces	
54" wide	
100% vinyl	
100% polyester knit backing	
Resilience® finish	
3SL01	White
3SL02	Pebble
3SL03	Mushroom
3SL04	Stone
3SL06	Rattan
3SL09	Seal
3SL10	Blue Fog
3SL11	Folkstone
3SL12	Shale
3SL13	Slate Grey
3SL14	Charcoal
3SL15	Carbon Dark
3SL28	Navy *

\* Color available on Eames® Tandem Sling Seating

#### Terra

Seating/Workspaces	
54" wide	
100% post-consumer recycled biodegradable polyester *	
4TE01	Spring Wood
4TE02	Zinc
4TE03	Pine Cone
4TE04	Charcoal

\* 1% biodegradation in 1,278 days under ASTM D5511 conditions. No evidence of further degradation.

#### Twine

Workspaces	
66" wide	
100% recycled polyester	
3TW01	Silver Birch
3TW02	Ivory
3TW03	Alabaster
3TW04	Bamboo
3TW05	Iceberg
3TW06	Charcoal
3TW07	Feather Grey
3TW08	Shale

#### Twist

Seating/Workspaces	
54" wide	
80% antimony-free polyester	
13% recycled polyester	
7% polyester	
8R05	Wicker
8R10	Poppy
8R14	Tin
8R15	Shale
8R16	Graphite
8R17	Birch
8R18	Sepia
8R22	Blueberry
8R23	Green Apple
8R26	Gunmetal
8R27	Cinder
8R29	Pekoe
8R33	Forest
8R35	Waterfall
8R36	Midnight Blue
8R37	Carbon Dark

#### Twist

Workspaces	
For systems products only.	
54" wide	
80% antimony-free polyester	
13% recycled polyester	
7% polyester	
5S03	Oyster

### Price Category 3

#### Ace

Seating	
54" wide	
100% polyurethane	
Polyester knit backing	
Stain resistant finish	
3AC01	Summer White
3AC02	White Ash
3AC03	Rye
3AC04	Metal
3AC05	Clay
3AC06	Chestnut
3AC08	Camelback
3AC09	Chipotle
3AC12	Artichoke
3AC13	Sepia Dark
3AC14	Aloe
3AC15	Flint
3AC16	Blue Sky
3AC17	Oceanside
3AC18	Midnight
3AC20	Frost
3AC21	Lead
3AC22	Black

#### Fractal

Seating/Workspaces	
58" wide	
84% recycled polyester	
16% polyester	
43Z01	Granite
43Z02	Golden Olive
43Z03	Verdant
43Z04	Cadet

Price category 3 continued on next page

# Textile Colors

continued

## GSA

### Price Category 3

continued

Ground Cloth®	
Workspaces	
66" wide	
100% polyester	
4701	Vapor Grey
4721	Warm White *
4722	Fog *
4723	Straw *
4724	Red Orange *
4726	Green Apple *
4727	Caribbean *
4728	Midnight *
4729	Cappuccino *

\* Colors available on Exclave®  
Video-friendly Tackable  
Boards and Stowage Tackable  
Backdrop

Latitude	
Seating	
Colors for Mirra 2 Chairs	
100% polyester	
8M10	Alpine
8M17	Black
8M21	Slate Grey
8M23	French Press
8M25	Dark Turquoise
8M26	Twilight

Meld – Maharam	
Workspaces	
54" wide	
68% post-consumer recycled polyester	
32% polyester	
PFOA-Free stain resistant	
ZM201/466387-201	Vast
ZM202/466387-202	Panda **
ZM203/466387-203	Skyline *
ZM204/466387-204	Knight **
ZM205/466387-205	Quill **
ZM206/466387-206	Pipe
ZM207/466387-207	Grate *
ZM208/466387-208	Gloss
ZM209/466387-209	Bulb
ZM210/466387-210	Bride
ZM211/466387-211	Stark
ZM212/466387-212	Seashell
ZM213/466387-213	Antler
ZM214/466387-214	Crater *
ZM215/466387-215	Perennial
ZM216/466387-216	Mulberry
ZM217/466387-217	Fuchsia *
ZM218/466387-218	Amethyst *
ZM219/466387-219	Merlot
ZM220/466387-220	Magma *
ZM221/466387-221	Rooster
ZM222/466387-222	Heat *
ZM223/466387-223	Clementine
ZM224/466387-224	Fox
ZM225/466387-225	Kiss *
ZM226/466387-226	Bare
ZM227/466387-227	Blonde
ZM228/466387-228	Mimosa
ZM229/466387-229	Comet *
ZM230/466387-230	Honeydew
ZM231/466387-231	Wild *
ZM232/466387-232	Vine
ZM233/466387-233	Seed
ZM234/466387-234	Kale *

Meld continued	
ZM235/466387-235	Waterfall *
ZM236/466387-236	Nordic *
ZM237/466387-237	Reef *
ZM238/466387-238	Wave
ZM239/466387-239	Isle **
ZM240/466387-240	Creek
ZM241/466387-241	Mariner *
ZM242/466387-242	Globe
ZM243/466387-243	Spa

\* Colors available on  
20-day lead time.  
\*\* Colors available on  
10-day lead time.

Parcel	
Seating/Workspaces	
54" wide	
100% recycled polyester	
4GE01	Gunmetal
4GE02	Brindle
4GE03	Bayou
4GE04	Pesto
4GE05	Golden Olive
4GE06	Copper Sea

Strands	
Workspaces	
66" wide	
100% recycled polyester	
8W01	Pebble
8W02	Porcelain
8W03	Taupe
8W04	Honey
8W05	Khaki
8W06	Rye
8W07	Wicker
8W08	Tin
8W09	Cool Grey

### Price Category 4

Daydream	
Seating	
54" wide	
48% wool	
41% recycled polyester	
9% nylon	
2% polyester	
3DM01	Rye Grass
3DM02	Silver Birch
3DM03	Pewter
3DM04	Graphite
3DM05	Black
3DM06	Lemongrass
3DM07	Permission
3DM08	Juniper
3DM09	Sea Grass
3DM10	Nightfall

Sync	
Seating	
55" wide	
100% polyester	
3SY01	Pine Cone
3SY03	Canyon
3SY04	Truffle
3SY06	Everglade
3SY08	Nightfall
3SY09	Dark Mineral
3SY10	Slate Grey
3SY11	Dark Carbon
3SY12	Black

# Textile Colors

continued

## GSA

### Price Category 5

Cozy	
Seating	
54" wide	
100% wool	
3CY01	Heathered Warm Grey
3CY02	Heathered Rye Grass
3CY03	Heathered Cool Grey
3CY05	Heathered Black
3CY06	Heathered Persimmon
3CY07	Heathered Loden
3CY09	Heathered Lagoon
3CY10	Heathered Twilight

Hopsak	
Seating/Workspaces	
56" wide	
100% recycled polyester	
14A20	Black
14A22	Raw Umber Dark
14A26	Grey Blue Dark
14A30	Sepia Dark
14A38	Emerald Dark
14A39	Yellow Dark
14A40	Orange
14A41	Sienna
14A42	Olive Green Dark
14A43	Crimson
14A44	Crimson Dark Dark
14A45	Violet Dark
14A46	Pink Dark Dark
14A47	Ultramarine Dark
14A48	Cobalt Blue
14A49	Terra Cotta
14A50	Ochre Dark

Method – Maharam	
Seating/Workspaces	
54" wide	
100% recycled polyester with 12% ocean-bound plastic	
40G01/466579-001	Inspire
40G02/466579-002	Rhea
40G03/466579-003	Noise
40G04/466579-004	Speedway
40G05/466579-005	Villanelle
40G06/466579-006	Maestro
40G07/466579-007	Destiny
40G08/466579-008	Possess
40G09/466579-009	Waterside
40G10/466579-010	Relax
40G11/466579-011	Delightful
40G12/466579-012	Parrotlet
40G13/466579-013	Verdurous
40G14/466579-014	Bosky
40G15/466579-015	Acreage
40G16/466579-016	Allude
40G17/466579-017	Tweed
40G18/466579-018	Korma
40G19/466579-019	Fossilize
40G20/466579-020	Cattail
40G21/466579-021	Shortcake
40G22/466579-022	Racecar
40G23/466579-023	Courtship
40G24/466579-024	Jam
40G25/466579-025	Sparrow

Nico - Maharam	
Seating/Workspaces	
54" wide	
63% wool	
21% polyester	
16% solution-dyed nylon	
ZNC01/466564-001	Alcazar
ZNC02/466564-002	Ironclad
ZNC03/466564-003	Tune
ZNC04/466564-004	Bridegroom
ZNC05/466564-005	Diode
ZNC06/466564-006	Jest
ZNC07/466564-007	Sanctuary
ZNC08/466564-008	Aquarius
ZNC09/466564-009	Houseboat
ZNC10/466564-010	Olympian
ZNC11/466564-011	Tennis
ZNC12/466564-012	Dressage
ZNC13/466564-013	Zing
ZNC14/466564-014	Bitterroot
ZNC15/466564-015	Gemini
ZNC16/466564-016	Posh
ZNC17/466564-017	Sizzle
ZNC18/466564-018	Cheerful
ZNC19/466564-019	Watermelon
ZNC20/466564-020	Toucan
ZNC21/466564-021	Rosin
ZNC22/466564-022	Jousting
ZNC23/466564-023	Jojoba
ZNC24/466564-024	Dromedary
ZNC25/466564-025	Toasty
ZNC26/466564-026	Casaba
ZNC27/466564-027	Greenhouse
ZNC28/466564-028	Sibyl
ZNC29/466564-029	Spearmint
ZNC30/466564-030	Pothos
ZNC31/466564-031	Calathea
ZNC32/466564-032	Landscape
ZNC33/466564-033	Espalier
ZNC34/466564-034	Gecko
ZNC35/466564-035	Meditation

Summit	
Seating	
54" wide	
100% silicone	
Polyester knit backing	
3SU02	Oyster
3SU03	Zinc
3SU04	Sparrow
3SU07	Black
3SU09	Beachglass
3SU10	Midnight

# Textile Colors

continued

GSA

Appendix: Textile Colors

## Price Category 6

Balance	
Seating	
For Embody® chairs	
100% polyester	
3512	Carbon
3513	Black

## Price Category 7

Customer's Own Leather
Seating
See Order Information in Appendices. Assigned lead-time textile. <a href="#">A</a>

## Price Category 8

No fabrics available at this time.

## Price Category 9

Gemma – Maharam
Seating
55" wide
85% wool
15% nylon
ZGE01/466568-001 Crinoline
ZGE02/466568-002 Angelic
ZGE03/466568-003 Savory
ZGE04/466568-004 Honeycomb
ZGE05/466568-005 Gilded
ZGE06/466568-006 Paddleboat
ZGE07/466568-007 Stagecoach
ZGE08/466568-008 Waterbuck
ZGE09/466568-009 Earnest
ZGE10/466568-010 Auric
ZGE11/466568-011 Carmine
ZGE12/466568-012 Serape
ZGE13/466568-013 Ferric
ZGE14/466568-014 Canyon
ZGE15/466568-015 Alembic
ZGE16/466568-016 Patio
ZGE17/466568-017 Sorrel
ZGE18/466568-018 Root
ZGE19/466568-019 Mansion
ZGE20/466568-020 Buff
ZGE21/466568-021 Starch
ZGE22/466568-022 Dawn
ZGE23/466568-023 Countryside
ZGE24/466568-024 Dewy
ZGE25/466568-025 Reliquary
ZGE26/466568-026 Deluge
ZGE27/466568-027 Overlay
ZGE28/466568-028 Electron
ZGE29/466568-029 Sheath
ZGE30/466568-030 Quietude
ZGE31/466568-031 Jargon
ZGE32/466568-032 Powder
ZGE33/466568-033 Tide
ZGE34/466568-034 Outwash
ZGE35/466568-035 Enamored
ZGE36/466568-036 Smitten
ZGE37/466568-037 Revere
ZGE38/466568-038 Mangosteen
ZGE39/466568-039 Allium
ZGE40/466568-040 Immense

Price category 9 continued on next page



# Textile Colors

continued

## GSA

### Price Category 9

continued

#### Gemma continued

ZGE41/466568-041	Chamber
ZGE42/466568-042	Cosmos
ZGE43/466568-043	Inkling
ZGE44/466568-044	Rainwater
ZGE45/466568-045	Shade
ZGE46/466568-046	Pendant
ZGE47/466568-047	Axial
ZGE48/466568-048	Fervent
ZGE49/466568-049	Legacy
ZGE50/466568-050	Caliber
ZGE51/466568-051	Temple
ZGE52/466568-052	Evenfall

#### Jasper - Maharam

Seating	
53" wide	
55% wool	
27% solution-dyed nylon	
18% cotton	
ZJA01/466563-001	Thrill
ZJA02/466563-002	Anise
ZJA03/466563-003	Grapefruit
ZJA04/466563-004	Lifeguard
ZJA05/466563-005	Heartfelt
ZJA06/466563-006	Corsage
ZJA07/466563-007	Earthenware
ZJA08/466563-008	Bear
ZJA09/466563-009	Firelight
ZJA10/466563-010	Dreamcatcher
ZJA11/466563-011	Bobcat
ZJA12/466563-012	Glacial
ZJA13/466563-013	Vaporize
ZJA14/466563-014	Trapdoor
ZJA15/466563-015	Halcyon
ZJA16/466563-016	Observatory
ZJA17/466563-017	Steamboat
ZJA18/466563-018	Aquathlon
ZJA19/466563-019	Cloudless
ZJA20/466563-020	Briny
ZJA21/466563-021	Magical
ZJA22/466563-022	Picnic
ZJA23/466563-023	Herbage
ZJA24/466563-024	Pasture
ZJA25/466563-025	Courtyard
ZJA26/466563-026	Leapfrog

#### Leather

Seating	
approx. 50 sq. ft. per hide	
100% leather	
2101	Ivory
2109	Black *
2110	Smoke
2111	Graphite
2112	Khaki
2113	Rattan
2114	Truffle
2115	Alpine
2116	Haze
2117	Sable Grey
2118	Dark Mineral **
2119	Dark Carbon ***
2120	Cranberry
2121	Deep Sea

\* Armpad color available on Aeron® Chair, Graphite.  
 \*\* Armpad color available on Aeron Chair, Mineral.  
 \*\*\* Armpad color available on Aeron Chair, Carbon.

### Price Category 10

#### Firma – Maharam

Seating	
55" wide	
78% wool	
22% nylon	
3KH01/466582-001	Wrath
3KH02/466582-002	Pantomime
3KH03/466582-003	Shaded
3KH04/466582-004	Prologue
3KH05/466582-005	Framework
3KH06/466582-006	Railroad
3KH07/466582-007	Grommet
3KH08/466582-008	Lunisolar
3KH09/466582-009	Snowpack
3KH10/466582-010	Coldsnap
3KH11/466582-011	Sealift
3KH12/466582-012	Brood
3KH13/466582-013	Intertidal
3KH14/466582-014	Confide
3KH15/466582-015	Secluded
3KH16/466582-016	Leisure
3KH17/466582-017	Portfolio
3KH18/466582-018	Strato
3KH19/466582-019	Fogbow
3KH20/466582-020	Snowcone
3KH21/466582-021	Kazoo
3KH22/466582-022	Esteem
3KH23/466582-023	Mackerel
3KH24/466582-024	Brooch
3KH25/466582-025	Caesious
3KH26/466582-026	Islet
3KH27/466582-027	Biosphere
3KH28/466582-028	Hilltop
3KH29/466582-029	Arboreal
3KH30/466582-030	Lineage
3KH31/466582-031	Comfrey
3KH32/466582-032	Circe
3KH33/466582-033	Ecosystem
3KH34/466582-034	Knack
3KH35/466582-035	Watt
3KH36/466582-036	Epiphany
3KH37/466582-037	Gamma
3KH38/466582-038	Taxicab
3KH39/466582-039	Varietal

#### Gemma Multi – Maharam

Seating	
55" wide	
85% wool	
15% nylon	
ZGF01/466569-001	Andromeda
ZGF02/466569-002	Dappled
ZGF03/466569-003	Lyra
ZGF04/466569-004	Flaunt
ZGF05/466569-005	Celluloid
ZGF06/466569-006	Hydrozoa
ZGF07/466569-007	Firefly
ZGF08/466569-008	Pisces
ZGF09/466569-009	Strath
ZGF10/466569-010	Erosion
ZGF11/466569-011	Cabaret
ZGF12/466569-012	Candytuft
ZGF13/466569-013	Juice
ZGF14/466569-014	Fairground
ZGF15/466569-015	Copperplate
ZGF16/466569-016	Sunbird
ZGF17/466569-017	Cinematic
ZGF18/466569-018	Clairvoyant
ZGF19/466569-019	Crocus
ZGF20/466569-020	Memoir
ZGF21/466569-021	Roulette
ZGF22/466569-022	Voltaic
ZGF23/466569-023	Compote
ZGF24/466569-024	Lambent
ZGF25/466569-025	Twister
ZGF26/466569-026	Chronicle
ZGF27/466569-027	Sidereal
ZGF28/466569-028	Tanzanite
ZGF29/466569-029	Crystalize
ZGF30/466569-030	Chromium
ZGF31/466569-031	Pallium
ZGF32/466569-032	Spectre
ZGF33/466569-033	Courgette
ZGF34/466569-034	Viper
ZGF35/466569-035	Sunlit
ZGF36/466569-036	Heavenly
ZGF37/466569-037	Vernal
ZGF38/466569-038	Cress
ZGF39/466569-039	Limn
ZGF40/466569-040	Horseradish

Price category 10 continued on next page

# Textile Colors

continued

## GSA

### Price Category 10

continued

Appendix: Textile Colors

#### Gemma Multi continued

ZGF41/466569-041 Shandy
ZGF42/466569-042 Granary
ZGF43/466569-043 Percolate
ZGF44/466569-044 Motor
ZGF45/466569-045 Unicorn
ZGF46/466569-046 Lobster
ZGF47/466569-047 Rhododendron
ZGF48/466569-048 Taffy
ZGF49/466569-049 Rishi
ZGF50/466569-050 Backcountry
ZGF51/466569-051 Buckthorn
ZGF52/466569-052 Coniferous
ZGF53/466569-053 Delphic
ZGF54/466569-054 Hieroglyph
ZGF55/466569-055 Eiderdown
ZGF56/466569-056 Sandbar
ZGF57/466569-057 Tanager

#### Gemma Multi Reverse – Maharam

Seating
55" wide
85% wool
15% nylon
ZGF58/466569-101 Andromeda
Reverse
ZGF59/466569-102 Dappled
Reverse
ZGF60/466569-103 Lyra
Reverse
ZGF61/466569-104 Flaunt
Reverse
ZGF62/466569-105 Celluloid
Reverse
ZGF63/466569-106 Hydrozoa
Reverse
ZGF64/466569-107 Firefly
Reverse
ZGF65/466569-108 Pisces
Reverse
ZGF66/466569-109 Strath
Reverse
ZGF67/466569-110 Erosion
Reverse

#### Gemma Multi Reverse continued

ZGF68/466569-111 Cabaret
Reverse
ZGF69/466569-112 Candytuft
Reverse
ZGF70/466569-113 Juice
Reverse
ZGF71/466569-114 Fairground
Reverse
ZGF72/466569-115 Copperplate
Reverse
ZGF73/466569-116 Sunbird
Reverse
ZGF74/466569-117 Cinematic
Reverse
ZGF75/466569-118 Clairvoyant
Reverse
ZGF76/466569-119 Crocus
Reverse
ZGF77/466569-120 Memoir
Reverse
ZGF78/466569-121 Roulette
Reverse
ZGF79/466569-122 Voltaic
Reverse
ZGF80/466569-123 Compote
Reverse
ZGF81/466569-124 Lambent
Reverse
ZGF82/466569-125 Twister
Reverse
ZGF83/466569-126 Chronicle
Reverse
ZGF84/466569-127 Sidereal
Reverse
ZGF85/466569-128 Tanzanite
Reverse
ZGF86/466569-129 Crystalize
Reverse
ZGF87/466569-130 Chromium
Reverse
ZGF88/466569-131 Pallium
Reverse
ZGF89/466569-132 Spectre
Reverse

#### Gemma Multi Reverse continued

ZGF90/466569-133 Courgette
Reverse
ZGF91/466569-134 Viper
Reverse
ZGF92/466569-135 Sunlit
Reverse
ZGF93/466569-136 Heavenly
Reverse
ZGF94/466569-137 Vernal
Reverse
ZGF95/466569-138 Cress
Reverse
ZGF96/466569-139 Limn
Reverse
ZGF97/466569-140 Horseradish
Reverse
ZGF98/466569-141 Shandy
Reverse
ZGF99/466569-142 Granary
Reverse
ZGFA0/466569-143 Percolate
Reverse
ZGFA1/466569-144 Motor
Reverse
ZGFA2/466569-145 Unicorn
Reverse
ZGFA3/466569-146 Lobster
Reverse
ZGFA4/466569-147 Rhododendron
Reverse
ZGFA5/466569-148 Taffy
Reverse
ZGFA6/466569-149 Rishi
Reverse
ZGFA7/466569-150 Backcountry
Reverse
ZGFA8/466569-151 Buckthorn
Reverse
ZGFA9/466569-152 Coniferous
Reverse
ZGFB0/466569-153 Delphic
Reverse

#### Gemma Multi Reverse continued

ZGFB1/466569-154 Hieroglyph
Reverse
ZGFB2/466569-155 Eiderdown
Reverse
ZGFB3/466569-157 Tanager
Reverse

#### Petra - Maharam

Seating
55" wide
70% wool
19% linen
11% nylon
ZP401/466580-001 Hieroglyph
ZP402/466580-002 Interior
ZP403/466580-003 Samovar
ZP404/466580-004 Calcite
ZP405/466580-005 Silversmith
ZP406/466580-006 Rivet
ZP407/466580-007 Carpolite
ZP408/466580-008 Bonbon
ZP409/466580-009 Dreamy
ZP410/466580-010 Bejewel
ZP411/466580-011 Sashimi
ZP412/466580-012 Spirula
ZP413/466580-013 Chalet
ZP414/466580-014 Reindeer
ZP415/466580-015 Nostalgia
ZP416/466580-016 Trove
ZP417/466580-017 Narcissus
ZP418/466580-018 Yurt
ZP419/466580-019 Congee
ZP420/466580-020 Genepy
ZP421/466580-021 Herbaceous
ZP422/466580-022 Paddock
ZP423/466580-023 Precious
ZP424/466580-024 Biome
ZP425/466580-025 Tinted
ZP426/466580-026 Pelagic
ZP427/466580-027 Bluebill
ZP428/466580-028 Chicory
ZP429/466580-029 Eaglet
ZP430/466580-030 Permafrost
ZP431/466580-031 Atlantic
ZP432/466580-032 Airstream
ZP433/466580-033 Debonair

# Textile Colors

continued

## GSA

### Price Category A

No fabrics available at this time.

### Price Category B

#### Messenger — Maharam

Seating/Workspaces	
54" wide	
78% post-industrial recycled polyester	
15% polyester	
7% nylon	
TI07/458640-007	Shadow
TI24/458640-024	Poppy
TI25/458640-025	Mao
TI29/458640-029	Onyx *
TI31/458640-031	Cloud *
TI38/458640-038	Depth *
TI40/458640-040	Nile *
TI41/458640-041	Azure *
TI45/458640-045	Cactus *
TI46/458640-046	Ice *
TI48/458640-048	Neon
TI50/458640-050	Hydrangea
TI53/458640-053	Tangelo
TI54/458640-054	Lumine *
TI58/458640-058	Snow **
TI60/458640-060	Peridot
TI61/458640-061	Capri *
TI62/458640-062	Ultramarine
TI63/458640-063	Squall
TI66/458640-066	Cassis
TI67/458640-067	Aster

#### Messenger continued

TI69/458640-069	Cherry
TI70/458640-070	Vibrant
TI71/458640-071	Satsuma *
TI72/458640-072	Maize
TI76/458640-076	Fossil
TI77/458640-077	Ash
TI78/458640-078	Tusk
TI79/458640-079	Oyster **
TI81/458640-081	Husk
TI84/458640-084	Robust
TI85/458640-085	Beyond
TI86/458640-086	Voyage *
TI87/458640-087	Everglade
TI89/458640-089	Blanch **
TI90/458640-090	Longspur
TI91/458640-091	Vireo
TI92/458640-092	Dipper
TI93/458640-093	Gale
TI94/458640-094	Hunter
TI95/458640-095	Lime
TI96/458640-096	Apple
TI97/458640-097	Krill
TI98/458640-098	Catalyst

\* Colors available on 20-day lead time.

\*\* Colors not available on Eames Molded Fiberglass and Molded Plastic Side Chairs.

### Price Category C

#### Manner - Maharam

Seating/Workspaces	
54" wide	
65% post-industrial recycled polyester	
35% post-consumer recycled polyester	
Z2701/466177-001	Magic
Z2702/466177-002	Carob
Z2703/466177-003	Porpoise
Z2704/466177-004	Flint
Z2705/466177-005	Hush *
Z2706/466177-006	Nuance
Z2711/466177-011	Ember
Z2712/466177-012	Wagon
Z2713/466177-013	Ablaze
Z2714/466177-014	Peel
Z2716/466177-016	Butterscotch
Z2717/466177-017	Harvest
Z2720/466177-020	Parakeet
Z2722/466177-022	Aquatic
Z2723/466177-023	Cottage
Z2724/466177-024	Dahlia
Z2725/466177-025	Vivid
Z2726/466177-026	Basin
Z2727/466177-027	Schooner
Z2728/466177-028	Slope
Z2729/466177-029	Silverpoint
Z2730/466177-030	Lattice
Z2731/466177-031	Smoky
Z2732/466177-032	Magnetic
Z2733/466177-033	Woad
Z2734/466177-034	Resolute
Z2735/466177-035	Cruise
Z2736/466177-036	Atmospheric
Z2737/466177-037	Cloudburst
Z2738/466177-038	Tidewater
Z2739/466177-039	Firth
Z2740/466177-040	Oceanside
Z2741/466177-041	Grandeur
Z2742/466177-042	Comfort
Z2743/466177-043	Dill
Z2744/466177-044	Poplar
Z2745/466177-045	Citronella
Z2746/466177-046	Passerine

Price category C continued on next page

# Textile Colors

continued

## GSA

### Price Category C

continued

Appendix: Textile Colors

Manner continued	
Z2747/466177-047	Southwest
Z2748/466177-048	Roseate
Z2749/466177-049	Charisma
Z2750/466177-050	Siltstone
Z2751/466177-051	Kimono
Z2752/466177-052	Valiant
Z2753/466177-053	Baroness

\* Color not available on Eames Aluminum Group, Executive Chairs, Upholstered Molded Plywood Chairs, and Sofa Compact.

Merit - Maharam	
Seating	
54" wide	
76% post-industrial recycled polyester	
24% polyester	
PFOA-Free stain resistant	

88Z01/466444-001	Trickle
88Z02/466444-002	Beluga
88Z03/466444-003	Gunmetal
88Z04/466444-004	Blackout
88Z05/466444-005	Superior
88Z06/466444-006	Ocean
88Z07/466444-007	Highborn
88Z08/466444-008	Immersed
88Z09/466444-009	Rainfall
88Z10/466444-010	Blizzard
88Z11/466444-011	Poolside
88Z12/466444-012	Steel
88Z13/466444-013	Zircon
88Z14/466444-014	Ripple
88Z15/466444-015	Aegean
88Z16/466444-016	Armada
88Z17/466444-017	Hedera
88Z18/466444-018	Rainforest
88Z19/466444-019	Gator
88Z20/466444-020	Vineyard
88Z21/466444-021	Pine
88Z22/466444-022	Kiwi
88Z23/466444-023	Kookaburra

Merit continued	
88Z24/466444-024	Bellini
88Z25/466444-025	Sunflower
88Z26/466444-026	Sandstorm
88Z27/466444-027	Mudder
88Z28/466444-028	Lynx
88Z29/466444-029	Farro
88Z30/466444-030	Manila
88Z31/466444-031	Starfish
88Z32/466444-032	Brass
88Z33/466444-033	Arrow
88Z34/466444-034	Gelato
88Z35/466444-035	Nectarine
88Z36/466444-036	Macaron
88Z37/466444-037	Alert
88Z38/466444-038	Goji
88Z39/466444-039	Cabernet
88Z40/466444-040	Eggplant
88Z41/466444-041	Hawk
88Z42/466444-042	Stag
88Z43/466444-043	Overcast

Metric - Maharam	
Seating/Workspaces	
54" wide	
51% post-industrial recycled polyester	
49% polyester	
Z302/466014-002	Fog
Z303/466014-003	Fleece
Z312/466014-012	Cardinal
Z313/466014-013	Lava
Z318/466014-018	Pollen
Z320/466014-020	Alligator
Z323/466014-023	Tar
Z324/466014-024	Anchor
Z326/466014-026	Admiral
Z327/466014-027	Seaport
Z328/466014-028	Scuba
Z329/466014-029	Skate
Z330/466014-030	Hopscotch
Z331/466014-031	Film
Z332/466014-032	Whale
Z333/466014-033	Downpour
Z334/466014-034	Middy

Metric continued	
Z335/466014-035	Talisman
Z336/466014-036	Hedgerow
Z337/466014-037	Snorkel
Z338/466014-038	Highway
Z339/466014-039	Canary
Z340/466014-040	Sunny
Z341/466014-041	Aztec
Z342/466014-042	Fruit
Z343/466014-043	Galah
Z344/466014-044	Kiln
Z345/466014-045	Moth

Murmur - Maharam	
Seating	
55" wide	
100% polyester	
PFOA-Free stain resistant	
8EY01/466446-001	Gust
8EY02/466446-002	Harmonica
8EY03/466446-003	Canopy
8EY04/466446-004	Dim
8EY05/466446-005	Peppercorn
8EY06/466446-006	Cauldron
8EY07/466446-007	Conquer
8EY08/466446-008	Rapids
8EY09/466446-009	Seawater
8EY10/466446-010	Baby
8EY11/466446-011	Elderberry
8EY12/466446-012	Iceberg
8EY13/466446-013	Tallgrass
8EY14/466446-014	Underground
8EY15/466446-015	Biome
8EY16/466446-016	Cask
8EY17/466446-017	Argan
8EY18/466446-018	Sundown
8EY19/466446-019	Ignite
8EY20/466446-020	Sultry
8EY21/466446-021	Sangria

### Price Category D

Bluff - Maharam	
Seating	
54" wide	
100% polyurethane	
Ink-resistant protective top coat	
Polyester backing	
8I801/466489-001	Loom
8I802/466489-002	Helm
8I803/466489-003	Cruller
8I804/466489-004	Folklore
8I805/466489-005	Beguile
8I806/466489-006	Sherpa
8I807/466489-007	Teleport
8I808/466489-008	Annex
8I809/466489-009	Lorimer
8I810/466489-010	Cinema
8I811/466489-011	Zip
8I812/466489-012	Coach
8I813/466489-013	Supernova
8I814/466489-014	Pirate
8I815/466489-015	Academy
8I816/466489-016	Disco
8I817/466489-017	Equator
8I818/466489-018	Brink
8I819/466489-019	Scene
8I820/466489-020	Petrichor
8I821/466489-021	Exotic
8I822/466489-022	Fauna
8I823/466489-023	Calabash
8I824/466489-024	Fuscous
8I825/466489-025	Wildling
8I826/466489-026	Blitz
8I827/466489-027	Allspice
8I828/466489-028	Lumos
8I829/466489-029	Pilot
8I830/466489-030	Jukebox
8I831/466489-031	Dugout
8I832/466489-032	Claret
8I833/466489-033	Flamenco

# Textile Colors

continued

## GSA

### Price Category E

Parallel – Maharam	
Workspaces	
66" wide	
100% recycled polyester	
TT03/901180-003	Fog
TT22/901180-022	Sterling
TT23/901180-023	Linen
TT24/901180-024	Pea
TT27/901180-027	Boulder
TT28/901180-028	Stream
TT29/901180-029	Shiitake
TT32/901180-032	Brandy
TT33/901180-033	Crater
TT36/901180-036	Quail

### Price Category F

Apt – Maharam	
Seating	
54" wide	
100% polyurethane/silicone	
Ink-resistant protective top coat	
Polyester backing	
82T12/466392-012	Iris
82T13/466392-013	Nocturnal
82T14/466392-014	Fluid
82T15/466392-015	Eden
82T16/466392-016	Galactic
82T17/466392-017	Shoreline
82T18/466392-018	Jade
82T19/466392-019	Garden
82T20/466392-020	Botanic
82T21/466392-021	Chartreuse
82T23/466392-023	Lyric
82T24/466392-024	Turmeric
82T25/466392-025	Bengal
82T26/466392-026	Core
82T27/466392-027	Mantle
82T28/466392-028	Sorbet
82T32/466392-032	Oak
82T33/466392-033	Castle
82T34/466392-034	Follow
82T35/466392-035	Elixir
82T36/466392-036	Charm
82T37/466392-037	Descend
82T38/466392-009	Sketch
82T39/466392-010	Glacier
82T40/466392-031	Fortress
82T41/466392-030	Lotus
82T42/466392-001	Coconut
82T43/466392-011	Cobblestone
82T44/466392-029	Bloom
82T45/466392-022	Crepe
82T46/466392-006	Hickory
82T47/466392-007	Constellation
82T48/466392-008	Labyrinth
82T49/466392-002	Vibe
82T50/466392-003	Stampede
82T51/466392-004	Lumber
82T52/466392-005	Gingerbread

Instill – Maharam	
Seating	
54" wide	
100% polyurethane	
Ink-resistant protective top coat	
Polyester backing	
74M01/466351-001	Page
74M02/466351-002	Limestone
74M03/466351-003	Bobwhite
74M04/466351-004	Loafer
74M07/466351-007	Shaker
74M08/466351-008	Doe
74M09/466351-009	Ride
74M10/466351-010	Squire
74M11/466351-011	Tannin
74M12/466351-012	Vitis
74M14/466351-014	Quail
74M15/466351-015	Brittanic
74M16/466351-016	Narwhal
74M18/466351-018	Stowaway
74M19/466351-019	Koala
74M20/466351-020	Dorsal
74M21/466351-021	Stealth

Keen - Maharam	
Seating	
54" wide	
61% polyester	
39% polyolefin	
PFOA-Free stain resistant	
Acrylic backing	
89N01/466433-001	Gaur
89N02/466433-002	Lock
89N03/466433-003	Elk
89N04/466433-004	Oatmeal
89N05/466433-005	Lakefront
89N06/466433-006	Argent
89N07/466433-007	Coyote
89N08/466433-008	Eventide
89N09/466433-009	Canal
89N10/466433-010	Rosemary
89N11/466433-011	Herb
89N12/466433-012	Ruby
89N13/466433-013	Loganberry

Ledger – Maharam	
Seating	
54" wide	
100% polyurethane	
V9G1/463770-001	001
V9G2/463770-002	002
V9G3/463770-003	003
V9G4/463770-004	004
V9GG/463770-017	017
V9GQ/463770-025	025
V9GS/463770-026	026
V9GU/463770-028	028
V9GV/463770-029	029
V9GW/463770-030	030
V9GX/463770-031	031
V9GY/463770-032	032
V9G18/463770-042	042
V9G19/463770-043	043
V9G20/463770-044	044
V9G21/463770-045	045
V9G22/463770-046	046

Loop - Maharam	
Seating	
57" wide	
48% post-industrial recycled polyester	
26% polyester	
26% post-consumer recycled polyester	
PFOA-Free stain resistant	
Acrylic Backing	
ZLL01/466469-001	Opossum
ZLL02/466469-002	Foundation
ZLL03/466469-003	Naval
ZLL04/466469-004	Buoyant
ZLL05/466469-005	Mockingbird
ZLL06/466469-006	Dynasty
ZLL07/466469-007	Zori
ZLL08/466469-008	Wildfire
ZLL09/466469-009	Floral
ZLL10/466469-010	Penguin

Price category F continued on next page

Appendix: Textile Colors

# Textile Colors

continued

## GSA

Appendix: Textile Colors

### Price Category F

continued

Pepper - Maharam	
Seating	
58" wide	
49% polyester	
41% post-industrial recycled polyester	
10% post-consumer recycled polyester	
PFOA-Free stain resistant	
Acrylic Backing	
8LW01/466486-001 Dojo	
8LW02/466486-002 Marengo	
8LW03/466486-003 Harlequin	
8LW04/466486-004 Pavlova	
8LW06/466486-006 Achioté	
8LW07/466486-007 Essence	
8LW08/466486-008 Genome	
8LW09/466486-009 Myriad	
8LW10/466486-010 Terrarium	

Strum - Maharam	
Seating	
54" wide	
100% polyurethane	
with silver-based antimicrobial	
Z3301/466122-001 Overcast	
Z3302/466122-002 Ridge	
Z3304/466122-004 Pigeon	
Z3307/466122-007 Bur	
Z3308/466122-008 Abalone	
Z3312/466122-012 Lemongrass	

### Price Category G

Compound - Maharam	
Seating	
54" wide	
100% polyurethane	
silane-based antimicrobial	
ZC201/466196-001 Quartz	
ZC203/466196-003 Weathered	
ZC204/466196-004 Cliff	
ZC205/466196-005 Espresso	
ZC206/466196-006 Smolder	
ZC207/466196-007 Blaze	
ZC208/466196-008 Mandarin	
ZC209/466196-009 Maple	
ZC210/466196-010 Perennial	
ZC211/466196-011 Mountainside	
ZC212/466196-012 Tundra	
ZC213/466196-013 Manatee	
ZC214/466196-014 Marine	
ZC215/466196-015 Twilight	
ZC216/466196-016 Shelter	
ZC217/466196-017 Vessel	
ZC218/466196-018 Smoke	
ZC219/466196-019 Fog	

Gild - Maharam	
Seating	
54" wide	
100% non-phthalate vinyl	
Ink-resistant protective top coat	
Polyester backing	
8AR01/466432-005 Grapevine	
8AR02/466432-009 Frosting	
8AR03/466432-007 Smokey	
8AR04/466432-003 Skylight	
8AR05/466432-011 Sandstone	
8AR06/466432-004 Hurricane	
8AR07/466432-002 Wreath	
8AR08/466432-001 Rainforest	
8AR09/466432-012 Fudge	
8AR10/466432-010 Lantern	
8AR11/466432-006 Planet	
8AR12/466432-008 Reflection	

### Price Category H

Circles — Maharam	
Seating	
55" wide	
70% cotton	
30% polyester	
ZT01/458310-001 Khaki	
ZT02/458310-002 Fatigue	
ZT03/458310-003 Document	
ZT04/458310-004 Engine	

Dot Pattern — Maharam	
Seating	
55" wide	
71% cotton	
29% polyester	
ZK01/458300-001 Document	
ZK02/458300-002 Taupe	
ZK04/458300-004 Red	
ZK05/458300-005 Navy	

Small Dot Pattern — Maharam	
Seating	
55" wide	
71% cotton	
29% polyester	
ZL01/458320-001 Document	
ZL02/458320-002 Sand	
ZL03/458320-003 Khaki	
ZL04/458320-004 Taupe	
ZL05/458320-005 Charcoal	
ZL06/458320-006 Document	
Reverse	
ZL07/458320-007 Red	
ZL08/458320-008 Yellow	
ZL09/458320-009 Green	

### Price Category I

Cursive – Maharam	
Seating	
54" wide	
67% solution-dyed acrylic	
33% solution-dyed polyester	
PFOA-Free stain resistant	
7CW01/466335-001 Fast	
7CW03/466335-003 Beachcomb	
7CW05/466335-005 Swift	
7CW06/466335-006 Jetstream	
7CW07/466335-007 Inkwell	
7CW08/466335-008 Rubber	

# Textile Colors

*continued*

## GSA

---

### Price Category J-V

No fabrics available at this time.

For more information about our products and services or to see a list of dealers, please visit us at [HermanMiller.com](http://HermanMiller.com) or call (800) 851 1196.

© 2024 Herman Miller, Inc., Zeeland, Michigan

#### Distribution Rights

Working together since 1956, Herman Miller and Vitra are the authentic sources of designs by Charles and Ray Eames, Alexander Girard, and George Nelson. All the designs shown in this book are protected by law. Herman Miller has obtained all rights to make and sell these designs. Also, Herman Miller holds exclusive worldwide manufacturing and distribution rights for these products with the following exceptions:

Charles and Ray Eames, George Nelson, and Alexander Girard—Worldwide distribution rights for furniture in all areas except Europe and the Middle East. For those areas, please contact Vitra.

Isamu Noguchi—Worldwide distribution rights for the Noguchi Rudder Table. Distribution rights for the Noguchi Table in North America and Central America only. For all other areas, please contact Vitra.

Magis—Exclusive distribution rights in the US and Canada. For all other areas, please contact Magis.

© **HermanMiller**, , Action Office, Aeron, Aside, Canvas Office Landscape, Caper, Cosm, Co/Struc, Eames, Embody, Ethospace, Exclave, Fine-Tune, FlexFront, Formcoat, Ground Cloth, Intent, Layout Studio, Lino, Maharam, Meridian, Mirra, Motia, Nelson, Pellicle, Perspectives, Plex, PostureFit, PostureFit SL, Sayl, Setu, Tu, Verus, Y-Tower and Zeph are among the registered trademarks of Herman Miller, Inc., and its owned subsidiaries.

™ AireWeave, Bubbletack, Canvas Vista, Cellular Suspension, Commend, Compass, Connect, DOT, Durawrap, Everywhere, Flex-Edge, Headway, Hopsak 2, Iota, Keyless Entry, Latitude, Lyris 2, Mora, Multiscrim, Nevi, OE1, OE1 Workspace Collection, Overlay, Renew, Stackable, Swoop, Thrive, TriFlex, Twist and Valor are among the trademarks of Herman Miller, Inc., and its owned subsidiaries.

Chemsurf® is a registered trademark of Wilsonart International.

Corian® is a registered trademark of E.I. du Pont de Nemours and Company Corporation.

FLEXNET™ is a trademark of Milliken & Company.

Floor Saver Glide® is a registered trademark of Carpin Manufacturing, Inc.

Forest Stewardship Council® is a registered trademark of the Forest Stewardship Council A.C. (FSC). We are FSC® certified (FSC® C102895).

FSC® is a registered trademark of the Forest Stewardship Council A.C. (FSC).

MicrobeCare™ is a trademark of Parasol Medical LLC.

Microsoft® and Natural® Keyboard are registered trademarks of Microsoft Corporation.

Place Textiles® is a registered trademark of Place Textiles.