



GSA prices effective October 6, 2025
(based on June 2, 2025, commercial price list)
Published January 2026

Multipurpose Seating Lino® Chairs

General Services Administration Federal Supply Service Authorized Federal Supply Schedule Price List

Online access to contract ordering information, terms and conditions, up-to-date pricing, and the option to create an electronic delivery order is available through GSA Advantage!®, a menu-driven database system. The Internet address for GSA Advantage! is www.gsaadvantage.gov.

Office Furniture
FSC/PSC 7110/7125
Contract Number: GS-03F-036DA
UEI: Q2K3MSZ843D8
Contract Period: December 21, 2025—December 20, 2030

MillerKnoll, Inc.
855 East Main Avenue
Zeeland, Michigan 49464
(616) 654 3000 Phone
(616) 654 8278 Fax
www.HermanMiller.com/government

Business Size: Large

Contract Information

1a. Special Item Numbers (SIN)

SIN 33721

Furniture Systems, Computer Furniture, Filing and Storage, Tables and Accessories, Upholstered Seating and Multi-Purpose Seating, Project Management, Reconfiguration and Relocation Services, Design/Layout and Installation Services

SIN 33721P

Packaged Offices

SIN 337127

Modular Laboratory Furniture Systems

SIN 339113H

Healthcare Furniture

SIN OLM

Order-Level Materials (OLMs)

This SIN is only for products and/or services used in direct support of the purchase of new furniture. It requires approval from the ordering Contract Officer. Please contact your local MillerKnoll Inc. representative to discuss the appropriate use of this SIN.

SIN 532289

Leasing

Contact MillerKnoll Inc participating government dealer for current leasing information.

1b. Lowest Priced Model

SIN 33721:	9M10018	\$9.10
SIN 337127:	TW113	\$6.18
SIN 339113H:	CR900NR	\$536.11

1c. Service Rates

Project Management

Furniture Project Manager: \$64.75 per hour
 Furniture Project Coordinator: \$49.00 per hour
 Build-Out Project Manager: \$80.00 per hour

Reconfiguration and Relocation Services

Not to exceed \$55 per hour.

See * Additional Notes for Installation & Reconfiguration and Relocation Services.

Design/Layout

Not to exceed \$65 per hour.

Installation Services

Not to exceed \$55 per hour (\$82.50 per hour for after-hours Installation).

See * Additional Notes for Installation & Reconfiguration and Relocation Services.

2. Maximum Order

SIN 33721, 337127, NEW, OLM

\$250,000 net product value

SIN 33721P

\$250,000 net value

SIN 339113H

\$500,000 net product value

3. Minimum Order

\$100 net

4. Geographic Coverage

Continental U.S.

Orders for Alaska, Hawaii, and Puerto Rico will be shipped F.O.B. inland carrier point of exportation.

5. Point of Production

Zeeland, Ottawa County, Michigan

Spring Lake, Ottawa County, Michigan

Elland, Yorkshire, United Kingdom

Hildebran, Burke County, North Carolina, USA

6. Pricing

Prices shown are list. Discounts include Industrial Funding Fee.

SIN 33721

Standard Lead Time, Single Order Net Purchase \$100 - 250,000, includes approved Herman Miller Options Products.

Product Line	Discount From List
Action Office 1	73.8%
Action Office 2	73.8%
Aeron	64.5%
Ambit Workspace Solutions	74.3%
Asari Chair	53.7%
Aside	64.2%
Bay Work Pod	56.7%
Boa Tables	73.8%
C-Style Overhead Storage	73.8%
Canvas Office Landscape Channel	74.8%
Canvas Office Landscape Dock	74.8%
Canvas Metal Desk	74.8%
Canvas Office Landscape Metal Storage	74.8%
Canvas Office Landscape Private Office	74.8%
Canvas Office Landscape Wood Storage	74.8%
Canvas Office Landscape Vista	74.8%
Canvas Office Landscape Wall	74.8%
Caper	61.5%
Commend Nurses Station	73.3%
Cosm	61.7%
Eames® Aluminum Group	58.7%
Eames Conference & Dining Tables	73.6%
Easton Family	54.91%
Embody	59.7%
Energy Distribution Systems	73.8%
Ethospace System	73.8%
Everywhere™ Tables	73.8%

Contract Information

continued

Exclave	61.7%
Fuld	59.7%
Geiger	53.0%
Headway™ Tables	73.8%
Intent Solution	58.7%
Layout Studio®	60.7%
Lighting	73.8%
Lino	63.7%
Meridian Laterals	67.3%
Meridian Pedestals	64.2%
Meridian Towers	62.7%
Meridian Storage	62.7%
Mirra 2	61.7%
Motia Tables	73.8%
NaughtOne	50.0%
Nemschoff	54.91%
Nevi™ Tables	73.8%
Nevi Link	73.8%
OE1 Boundary	72.8%
OE1 Community Elements	61.7%
OE1 Micro Packs	73.8%
OE1 Storage	72.8%
OE1 Tables and Benching	73.8%
Overlay™	62.7%
Plex® Lounge Furniture	59.5%
Pronta Stacking Chair	57.7%
Public Office Landscape	61.7%
Renew™ Tables	73.8%
Renew Link	73.8%
Sayl	62.2%
Setu	59.7%
Spout Sit-to-Stand Table	73.8%
Swoop Lounge Furniture	60.7%
Thrive Portfolio	62.0%
Thrive Portfolio-CBS Products Extension	62.0%
Tu Lateral Files	74.3%
Tu Pedestals	73.8%
Tu Storage	74.3%
Tu Towers	74.3%
Tu Wood Cases	74.3%
Tu Wood Cubbies	74.3%
Tu Wood Credenzas	74.3%
Tu Wood Pedestals	74.3%
Tu Wood Towers	74.3%
Valor™ Family	54.91%
Verus	63.7%
Zeph	60.2%

Services

Please refer to section 19 for Terms and Conditions of Installation/ Reconfiguration and Relocation Services.

Project Management

Services under this SIN may be used only in conjunction with the purchase of new furniture. Please contact your local MillerKnoll Inc. representative to discuss the available labor categories (listed below). The hourly rates listed are "Not To Exceed" or "NTE" values.

Furniture Project Manager: \$64.75 per hour
 Furniture Project Coordinator: \$49.00 per hour
 Build-Out Project Manager: \$80.00 per hour

Reconfiguration and Relocation Services

Reconfiguration and Relocation Services will be provided by MillerKnoll Inc. or its participating dealer based on a fee not to exceed \$55 per hour.

See * Additional Notes for Installation & Reconfiguration and Relocation Services.

Design/Layout

Design service will be provided by MillerKnoll Inc. or its participating dealer based on a fee not to exceed \$65 per hour.

Installation Services

Installation Services will be provided by MillerKnoll Inc. or its participating dealer based on a fee not to exceed \$55 per hour (\$82.50 per hour for after-hours Installation).

See * Additional Notes for Installation & Reconfiguration and Relocation Services.

SIN 337127

Standard Lead Time, Single Order Net Purchase \$100 - 250,000, includes approved Herman Miller Options Products.

Product Line	Discount From List
Action Lab	58.5%
Compass System	58.5%
Co/Struc System	58.5%
Healthcare Carts	18.0%
Mora System	58.5%
Bedside Cabinets	58.5%

SIN 33721P

Packaged Office Furniture - Maximum Order \$250,000 (net).

Includes packaged furniture solutions for customers needing to furnish an office.

SIN 339113H

Standard Lead Time, Single Order Net Purchase \$100 - 500,000, includes approved Herman Miller Options Products.

Product Line	Discount From List
Nemschoff Healthcare Furniture	54.91%

7. Quantity Discounts

Reference item #6.

8. Payment Terms

Net 30 days

9. Foreign Items

None

Contract Information

continued

10. Time of Delivery

- a. 90 day ARO
- b. Expedited delivery: Items listed in the 10-Day section of the catalogs are available for expedited delivery.
- c. Overnight/2-day delivery: Select items may be available for overnight or 2-day delivery. Contact MillerKnoll Inc. or a participating dealer for availability and rates.
- d. Urgent requirements: Agencies may contact contractor or participating dealer to request faster delivery.

11. F.O.B.

F.O.B. destination except Alaska, Hawaii, and Puerto Rico, which will be shipped F.O.B. inland carrier point of exportation.

12. Ordering Address

- a. MillerKnoll Inc.
Government Customer Care 0161
855 East Main Avenue
Zeeland MI 49464.
- b. For supplies and services, the ordering procedures information on Blanket Purchase Agreements (BPA's) are found in Federal Acquisition Regulation (FAR) 8.405-3.

13. Payment Address.

MillerKnoll Inc.
22764 Network Place
Chicago, IL 60673-1227

14. Warranty

MillerKnoll Inc. commercial warranty applies.

15. Export Packing Charge

Prices supplied on request.

16. Rental Maintenance and Repair Terms

Not applicable

17. Terms and Conditions of Installation/Reconfiguration and Relocation Services

* Additional Notes for Installation & Reconfiguration and Relocation Services:

FOB Destination (Drop Ship): Price includes product delivery to the site, brought to the tailgate of the truck. The purchaser is responsible for unloading.

Prices effective up to the maximum order by SIN only. Above the MO, pricing shall be negotiated on a case-by-case basis between the client and local dealer.

Standard Services are Subject to the Following Conditions:

Installation will be performed during normal weekday working hours.

Adequate facilities for delivery, unloading, moving and staging/storing the product during the installation process shall be provided.

Service work will not be hindered by other trades.

Electric, heat, and adequate elevator service will be furnished without charge.

The immediate installation area shall be complete and free of debris including the carpet/flooring before installation commences.

Any work requiring a licensed electrician is the responsibility of the buyer.

Additional Charges May Apply For:

Major Metro Markets and any non-ground floor installation.

Major Metro Markets include large population centers and urban environments.

Installation in a clinical/medical environment.

Special restrictions or limits established by local laws, ordinances or the directions of the buyer, including but not limited to restrictions on transportations of materials, street access to the job site and/or dock facilities.

Installations outside of a 50 mile radius of the servicing dealer.

Local Prevailing Wage and/or Union Labor Rates.

Any additional charges shall be quoted by the dealer and approved by the buyer prior to performance of the work.

18. Terms and Conditions of Repair Parts

Not applicable

19. Service and Distribution Points

For service and distribution points nearest you, call (800) 851 1196.

20. Participating Dealers

Access Herman Miller web site for current list of participating dealers: www.HermanMiller.com/where-to-buy/contact-a-dealer/. Select your market by using the filter.

21. Preventive Maintenance

Not applicable

22a. Special Attributes.

2021

The OE1 Trolley and Micro Packs are both winners of the 2021 Archiproducts international design competition in the Office Category.

MillerKnoll is named to Michigan's Best and Brightest in Wellness List for 2021.

OE1 is named winner of Wallpaper's "Most Futuristic Furniture" Category as part of their first-ever Smart Space Awards.

OE1 receives the Workplace category award from Fast Company's 2021 Innovation by Design Awards.

MillerKnoll is named to Fast Company's Annual List of the World's Most Innovative Companies for 2021.

Contract Information

continued

MillerKnoll is recognized as a “Disclosure Leader” by the Chemical Footprint Project (CFP).

MillerKnoll is named to Newsweek’s List of America’s Most Responsible Companies 2021.

2020

Herman Miller is recognized with a 2020 FSC® Leadership Award for our commitment to responsible forestry management.

Working Mother names Herman Miller as one of the Best Companies for Dads.

Cosm, by Studio 7.5, receives an iF Gold Award in the Office and Industry category at the iF World Design Awards 2020.

2019

Mora System casework, designed by Collective Ten for Herman Miller, receives silver in the Industrial and Life Science Design/ Medical Furniture category at the European Product Design Awards.

Mora System casework is awarded GOOD DESIGN Award 2019, selected for design excellence and innovation.

TIME Magazine names Cosm to its list of 100 Best Inventions of 2019.

Herman Miller is recognized as a silver level Certified Veteran-Friendly Employer by the Michigan Veterans Affairs Agency for a commitment to veteran hiring, retention, and development.

Herman Miller is named “Frontrunner” in Chemical Footprint Project by Clean Production Action for our chemical management policies and practices.

Herman Miller receives International Interior Design Association and Contract’s best showroom design award in the “Large Showroom” category at NeoCon.

Cosm, designed by Studio 7.5 for Herman Miller, receives a Red Dot Best of the Best Product Design Award in the “Office Chairs” category.

Lino, designed by Sam Hecht and Kim Colin for Herman Miller, receives an iF Design Award in the Product Design category.

2018

Overlay, designed by Birsell+Seck, receives Interior Design Best of Year Award in the Partitions and Wall Systems category.

Herman Miller receives Gold Medal from EcoVadis in recognition of Corporate Social Sustainability achievement measured in categories of environment, labor and human rights, ethics, and sustainable procurement. EcoVadis operates the first web-based collaborative platform that allows companies to assess the environmental and social performance of their global suppliers.

Aeron receives Good Design Award from The Chicago Athenaeum Museum of Architecture and Design.

The Cosm Chair wins Mix Interiors “Product of the Year—Task” award.

2017

Herman Miller receives “Rising Star Award” from the Michigan Veterans Affairs Agency (MVAA) for exhibiting new and novel approaches to veteran recruitment and hiring.

Herman Miller receives a 2017 SEAL (Sustainability, Environmental Achievement and Leadership) Business Sustainability Award. SEAL Award winners are determined by a holistic methodology measuring applicants against established benchmarks that demonstrate impact and progress toward creating a healthy planet and a sustainable future.

Herman Miller is named one of the Best and Brightest in Wellness for the 5th year in a row.

Herman Miller once again earns the WorldatWork Seal of Distinction, a unique standard of excellence in work-life effectiveness that shows we provide a distinct, mutually beneficial workplace experience. Herman Miller is the only furniture manufacturer among the 160 companies across the U.S. and Canada honored with the award.

Herman Miller’s Mora wins Nightingale Silver Award in the “Furniture Collections” category at the 2017 Healthcare Design Conference.

2016

Herman Miller is recognized as the Business of the Year at the Annual Meeting of the West Michigan Environmental Action Council (WMEAC) for being an outstanding partner in support of the growth of WMEAC’s programs. WMEAC’s award goes to the business with the greatest depth and breadth of support, unwavering dedication to environmental action in West Michigan, and a strong corporate commitment to environmental advocacy.

The 101 Best and Brightest Sustainable Companies once again (5th consecutive year) recognizes Herman Miller as an organization in Michigan (and for the first time, in the nation) that exhibits leadership and innovation in its approach to sustainability. This award celebrates those companies that are making their businesses more sustainable, the lives of their employees better, and the community, both locally and globally, more responsible as a whole.

Herman Miller is recognized as a 2016 Healthiest 100 Workplace in America, ranking 49th in the country for our commitment to health and exceptional corporate wellness programming.

Herman Miller receives the Best and Brightest in Wellness Award for the 4th year in a row. This program is an innovative initiative that recognizes and celebrates quality and excellence in health awareness.

Contract Information

continued

The Michigan Occupational Safety and Health Administration renews Herman Miller's "Star" status, the highest workplace safety and health designation, for the Hickory facility in Spring Lake.

Plex Lounge Furniture from Herman Miller receives #MetropolisLikes award at NeoCon 2016.

Plex Lounge Furniture from Herman Miller receives Interior Design HiP Award for Workplace Seating/Lounge at NeoCon 2016.

Herman Miller again earns the WorldatWork Work-Life 2016 Seal of Distinction. This award identifies organizations that focus on programs that promote work-life balance and overall well-being.

22b. Section 508 Compliance

Not applicable

23. Unique Entity ID: Q2K3MSZ843D8

24. Registered in System for Award Management (www.SAM.gov) Database

25. Cancellation

Prior to production, no cancellation charge will apply. After production, only actual cost incurred that the contractor can demonstrate if items are sold after 3 months.

26. Restocking Charges

Agencies must notify the contractor for authorization prior to returning any items. The customer agency will be required to pay all packaging and return freight charges. A restocking fee of 50% for Systems Furniture and 35% for all other product lines will be charged for any returned items.

Returns and restocking policy is not applicable to Options products, products under SIN 337127, 339113H, NaughtOne and Nemschoff products.

MillerKnoll Inc. Miscellaneous Information:

Federal ID Number: 38-0837640

Commercial and Government Entity Code (CAGE): 40636

Data Universal Numbering System (DUNS) 00-601-2801

Commercial Entity Code (CEC): 00702290J

Introduction	page 2
Lino® Chairs	3
Work Chairs	5
Work Stool	9
<hr/>	
Appendices	
20-Day or Less/Assigned Lead-Time Order Information	
Casters and Glides	
<hr/>	
For the latest materials information, refer to the Materials pages on HermanMiller.com.	

Introduction

A Note on the Organization of This Book

There are a few signals that will help you understand the organization of this book. Once you know them, you should be able to find your way around easily.

Like a newspaper, this book is formatted with columns of text and illustrations that run vertically.

Information wraps from one column to the next and continues for as many pages as it needs to.

Black bars are clues.

A black bar at the top of a page signals the start of information about a product.

This information is divided into two sections, each signaled by a black bar. Product Information includes a description, additional notes, and dimensional drawings. Specification Information, which always begins at the top of a column, includes a series of steps. Each step represents a decision you need to make in order to complete your product number. Steps must be followed sequentially. The number of pages needed to complete information on a product varies; some will be complete in one page; others may fill three or four pages. Just continue going through the steps until you run into the next product, signaled by the black bar at the top of the page.

Black tabs running along the outside edge of the page help you locate what section you are in or what section you want to go to. You can thumb forwards or backwards to find a section; tabs and text appear on both sides of the page.

The additional pages in the back of the book include the appendices and indices. They are signaled by a long black bar running along the outside edge of the page.

The index is presented two ways.

The first index is in alphabetical order by product name. It can be helpful if you are new to the products and numbering scheme or if you are looking for a type of product, such as work chair or round table.

The second index is by product number. It lists, in alphanumeric order, the base product number, typically a five-digit number.

General Information

This book is effective October 6, 2025, subject to change without notice. Products may be purchased from authorized Herman Miller dealers who will quote prices upon request. For more information about our products and services or to see a list of dealers, visit www.HermanMiller.com.

All prices are list prices. Additional services, such as planning services, design, storage, and installation, are not included and must be added to these prices when the additional services are requested.

Illustrations, specifications, and prices are based on the latest information at the time of publication. The right is reserved to make changes at any time without notice in prices, fabrics, finishes, materials, specifications, and models, and also to discontinue models and finishes.

Dimensions shown in the drawings are engineering drawing dimensions rounded up to the nearest $\frac{1}{8}$ ". Product is shipped set up or knocked down. Products that include "Shipped knocked down" in the description require some assembly. If this statement does not appear in the description, the product is shipped assembled.

Service problems are normally handled by a Herman Miller authorized dealer. Where this cannot be accomplished on a local level, service problems should be referred to the Customer Care Representative for your region, Herman Miller, Inc., Zeeland, Michigan 49464.

20-Day or Less/Assigned Lead-Time Shipments

All products and options in this price book not designated by an Assigned Program icon  will ship in **20 business days or less** after being acknowledged by Herman Miller.

Products and options designated by an  are on the assigned lead-time program and may ship in 20 days, less than 20 days, or more than 20 days from order acknowledgement.

Work Seating

Stools

Work Chair, Suspension Back -
Assembled

MI1B3



Product Information

Description

This chair has an upholstered seat with Duo suspension back. It has a 5-star base and 2 pneumatic height adjustment options. Chair comes standard with passive sacral support and is available with optional adjustable lumbar support with sacral support. Back frame, 5-star base, arms, arm pads and tilt controls are offered in black as standard with the option of mineral. A polished aluminum 5-star base is an option with either black or mineral frame finish configuration.

Tilt options include semi-synchronous with tilt limiter, synchronous with tilt limiter, and synchronous with tilt limiter and seat angle. All tilts have the option of fixed seat or an adjustable seat depth with 2 3/4" range. The tilt limiter allows the user to set the tilt range to limit the amount of recline.

The synchronous with tilt limiter and seat angle allows the user to set the tilt range and select a 5° forward seat angle

Arm choices include no arms, fixed arms, height-adjustable arms with 4" vertical range, and fully adjustable arms that adjust 4" vertically, 2" front to back, and 1 1/4" horizontally.

Notes

To order ready-to-assemble chair, order (MI2B3) separately.

Arms can be removed in the field.

For information on casters, see Casters and Glides in appendices.

Customer's Own Material (COM) on the seat requires 0.79 yards. Customer's Own Leather (COL) on the seat requires 9.33 square feet. See Order Information in appendices.

Dimensions

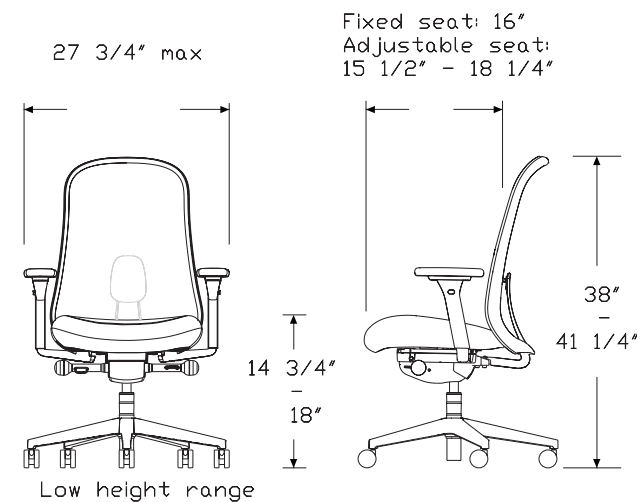
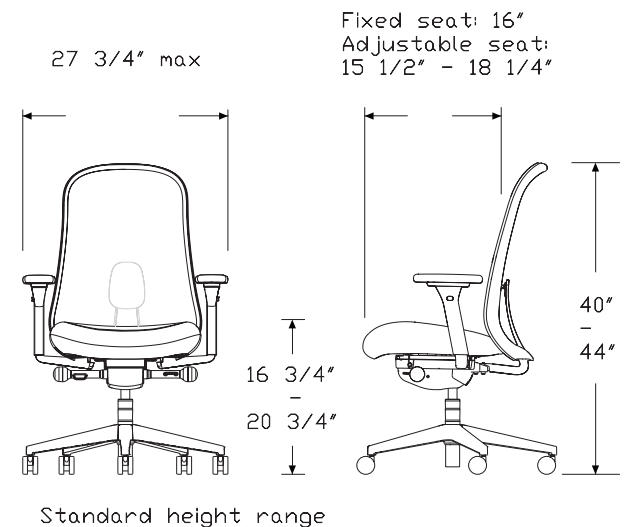

Work Chair, Suspension Back -
Assembled *continued*

Lino® Work Seating

Specification Information		
Step 1.		
MI1B3		
Step 2. Height Adjustment		
1	low-height range	+\$891
2	standard-height range	+\$891
Step 3. Tilt		
5	semi synchronous with tilt limiter	+\$0
6	synchronous with tilt limiter	+\$51
7	synchronous with tilt limiter and seat angle	+\$99
Step 4. Arms		
N	no arms	+\$0
P	fixed arms	+\$128
H	height-adjustable arms	+\$145
A	fully adjustable arms	+\$242
Step 5. Seat-Depth Adjustment		
F	fixed seat depth	+\$0
A	adjustable seat depth	+\$131
Step 6. Back Support Option		
N2	no additional support	+\$0
AJ	adjustable lumbar with sacral support	+\$53
Step 7. Base/Frame Finish		
BK	black base/black frame	+\$0
BKV	black base/mineral frame	+\$55
VPR	mineral base/mineral frame	+\$60
68	polished aluminum base/black frame	+\$119
PAM	polished aluminum base/mineral frame	+\$179
Step 8. Casters		
BB	2½" hard caster, black yoke, carpet only	+\$0
GF	2½" glide, hard floors or carpet	+\$25
C7	2½" caster, black yoke, hard floors or carpet	+\$50
C9	2½" braking caster, black yoke, hard floors or carpet	+\$50
SC8	2½" caster, black yoke, hard floors or carpet with quiet roll technology	+\$50
Step 9. Duo Suspension Material		
Price Category 1		+\$0

Step 10. Seat Fabric	
Price Category 1	+\$0
Price Category 10	+\$288
Price Category 2	+\$8
Price Category 3	+\$17
Price Category 4	+\$34
Price Category 5	+\$56
Price Category 7	+\$109
Price Category 8	+\$163
Price Category 9	+\$181
Price Category B	+\$31
Price Category C	+\$43
Price Category D	+\$55
Price Category E	+\$66
Price Category F	+\$85
Price Category G	+\$112
Price Category H	+\$134
Price Category I	+\$158
Price Category J	+\$182
Price Category L	+\$229

Work Chair, Suspension Back -
Ready to Assemble

MI2B3



Product Information

Description

This ready-to-assemble chair has an upholstered seat with Duo suspension back. It has a 5-star base and 2 pneumatic height adjustment options. Chair comes standard with passive sacral support and is available with optional adjustable lumbar support with sacral support. Back frame, 5-star base, arms, arm pads and tilt controls are offered in black as standard with the option of mineral. A polished aluminum 5-star base is an option with either black or mineral frame finish configuration.

Tilt options include semi-synchronous with tilt limiter, synchronous with tilt limiter, and synchronous with tilt limiter and seat angle. All tilts have the option of fixed seat or an adjustable seat depth with 2 3/4" range. The tilt limiter allows the user to set the tilt range to limit the amount of recline.

The synchronous with tilt limiter and seat angle allows the user to set the tilt range and select a 5° forward seat angle

Arm choices include no arms, fixed arms, height-adjustable arms with 4" vertical range, and fully adjustable arms that adjust 4" vertically, 2" front to back, and 1 1/4" horizontally.

Notes

To order assembled chair, order (MI1B3) separately.

Arms can be removed in the field.

For information on casters, see Casters and Glides in appendices.

Customer's Own Material (COM) on the seat requires 0.79 yards. Customer's Own Leather (COL) on the seat requires 9.33 square feet. See Order Information in appendices.

Dimensions

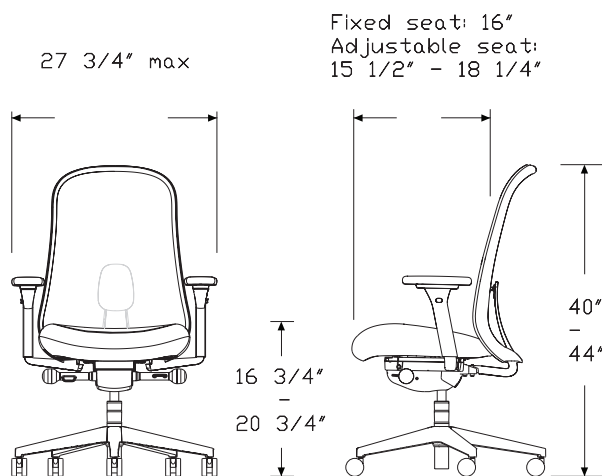

Standard height range

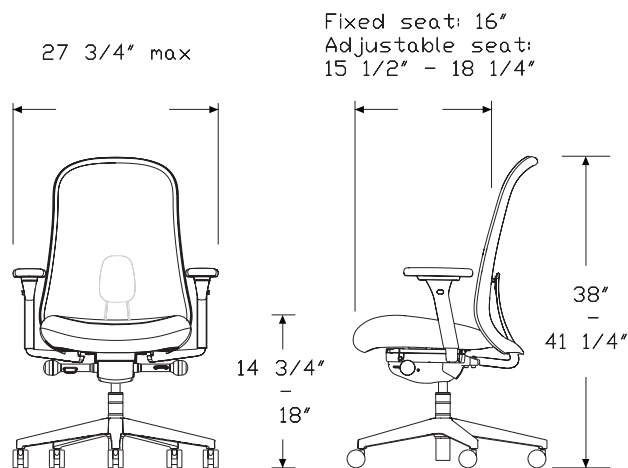

Low height range

Work Chair, Suspension Back -
Ready to Assemble *continued*

Lino® Work Seating

Specification Information		
Step 1.		
MI2B3		
Step 2. Height Adjustment		
1	low-height range	+\$764
2	standard-height range	+\$764
Step 3. Tilt		
5	semi synchronous with tilt limiter	+\$0
6	synchronous with tilt limiter	+\$49
7	synchronous with tilt limiter and seat angle	+\$99
Step 4. Arms		
N	no arms	+\$0
P	fixed arms	+\$123
H	height-adjustable arms	+\$139
A	fully adjustable arms	+\$232
Step 5. Seat-Depth Adjustment		
F	fixed seat depth	+\$0
A	adjustable seat depth	+\$126
Step 6. Back Support Option		
N2	no additional support	+\$0
AJ	adjustable lumbar with sacral support	+\$53
Step 7. Base/Frame Finish		
BK	black base/black frame	+\$0
BKV	black base/mineral frame	+\$55
VPR	mineral base/mineral frame	+\$60
68	polished aluminum base/black frame	+\$119
PAM	polished aluminum base/mineral frame	+\$179
Step 8. Casters		
BB	2½" hard caster, black yoke, carpet only	+\$0
GF	2½" glide, hard floors or carpet	+\$25
C7	2½" caster, black yoke, hard floors or carpet	+\$50
C9	2½" braking caster, black yoke, hard floors or carpet	+\$50
SC8	2½" caster, black yoke, hard floors or carpet with quiet roll technology	+\$50
Step 9. Duo Suspension Material		
Price Category 1		+\$0

Step 10. Seat Fabric	
Price Category 1	+\$0
Price Category 10	+\$288
Price Category 2	+\$8
Price Category 3	+\$17
Price Category 4	+\$34
Price Category 5	+\$56
Price Category 7	+\$109
Price Category 8	+\$163
Price Category 9	+\$181
Price Category B	+\$31
Price Category C	+\$43
Price Category D	+\$55
Price Category E	+\$66
Price Category F	+\$85
Price Category G	+\$112
Price Category H	+\$134
Price Category I	+\$158
Price Category J	+\$182
Price Category L	+\$229



Product Information

Description

This stool has an upholstered seat with Duo suspension back. It has a 5-star base and pneumatic height adjustment. Stool comes standard with passive sacral support and is available with optional adjustable lumbar support with sacral support. Back frame, 5-star base, arms, arm pads and tilt controls are offered in black as standard with the option of mineral. A polished aluminum 5-star base is an option with either black or mineral frame finish configuration.

Tilt options include height adjustable and synchronous with tilt limiter. Height adjustable option does not recline. The synchronous with tilt limiter option allows the user to set the tilt range to limit the amount of recline.

Arm choices include no arms, fixed arms, height-adjustable arms with 4" vertical range, and fully adjustable arms that adjust 4" vertically, 2" front to back, and 1 1/4" horizontally.

Notes

Arms can be removed in the field.

For information on casters, see Casters and Glides in appendices.

Customer's Own Material (COM) on the seat requires 0.79 yards. Customer's Own Leather (COL) on the seat requires 9.33 square feet. See Order Information in appendices.

Dimensions

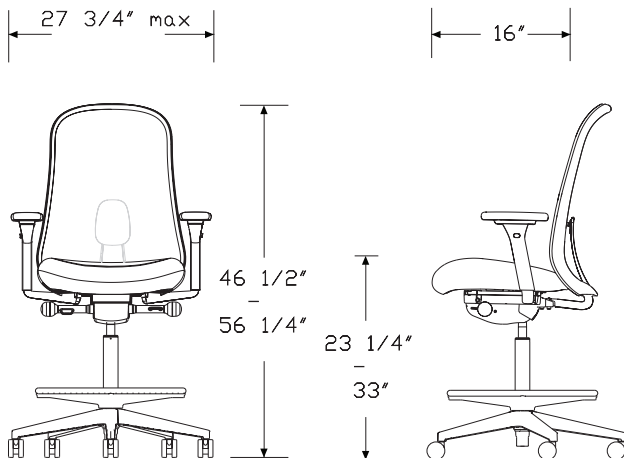

Specification Information

Step 1.

MI7B3

Step 2. Height Adjustment

1	standard stool height	+\$1061
---	-----------------------	---------

Step 3. Tilt

5	height adjustable	+\$0
6	synchronous with tilt limiter	+\$99

Step 4. Arms

N	no arms	+\$0
P	fixed arms	+\$128
H	height-adjustable arms	+\$145
A	fully adjustable arms	+\$242

Step 5. Seat Adjustment

F	fixed seat depth	+\$0
---	------------------	------

Step 6. Back Support Option

N2	no additional support	+\$0
AJ	adjustable lumbar with sacral support	+\$53

Step 7. Base/Frame Finish

BK	black base/black frame	+\$0
BKV	black base/mineral frame	+\$55
VPR	mineral base/mineral frame	+\$60
68	polished aluminum base/black frame	+\$119
PAM	polished aluminum base/mineral frame	+\$179

Step 8. Casters

BB	2 1/2" hard caster, black yoke, carpet only	+\$0
GF	2 1/2" glide, hard floors or carpet	+\$25
C7	2 1/2" caster, black yoke, hard floors or carpet	+\$50
C9	2 1/2" braking caster, black yoke, hard floors or carpet	+\$50
SC8	2 1/2" caster, black yoke, hard floors or carpet with quiet roll technology	+\$50

Step 9. Duo Suspension Material

Price Category 1	+\$0
------------------	------

Stool, Work, Suspension Back

continued

Lino® Stools



Step 10. Seat Fabric	
Price Category 1	+\$0
Price Category 10	+\$288
Price Category 2	+\$8
Price Category 3	+\$17
Price Category 4	+\$34
Price Category 5	+\$56
Price Category 7	+\$109
Price Category 8	+\$163
Price Category 9	+\$181
Price Category B	+\$31
Price Category C	+\$43
Price Category D	+\$55
Price Category E	+\$66
Price Category F	+\$85
Price Category G	+\$112
Price Category H	+\$134
Price Category I	+\$158
Price Category J	+\$182
Price Category L	+\$229

20-Day or Less/Assigned Lead-Time Order Information

GSA

20-Day or Less and Assigned Lead-Time Programs

20-day or less and assigned lead-time products are designed for established Herman Miller dealers with pre-approved credit.

Products are distributed from multiple manufacturing facilities across the United States. All products and options not designated by an Assigned Lead-Time icon  will ship in 20 business days or less after being acknowledged by Herman Miller. Products and options designated by an  are on the assigned lead-time program and will ship in 20 days, less than 20 days, or more than 20 days from order acknowledgement.

Ordering Procedure

Please place orders through Order Manager. If this is not available to you, place orders through mail or fax. Verbal purchase orders will not be accepted.

Order Entry fax number for Meridian® Filing and Storage:
(616) 846 9236.

Order Entry fax number for all other products:
(616) 654 3085.

For more information, contact your Customer Care representative at: (866) 854 3048 ext 3400.

Shipments and Delivery

Per Herman Miller Terms and Conditions.

Changes and Cancellation

Per Herman Miller Terms and Conditions.



Casters and Glides

GSA

⚠	WARNING	⚠
Depending on the floor surface, chair may unexpectedly roll away from user when entering or exiting the chair, possibly leading to unexpected injury. Please refer to descriptions of floor types when selecting casters.		

32 Caster

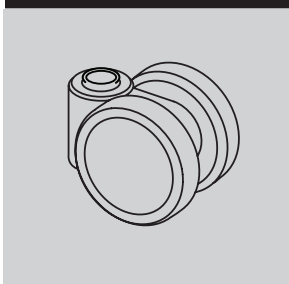

1⁷/₈-inch-diameter hard double-wheel caster; black nylon wheels and yoke; for use on carpet only
 Applicable on:
 Sayl® Chairs

BB Caster

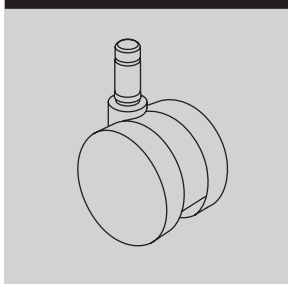

2¹/₂-inch-diameter hard double-wheel caster; black nylon wheels and yoke; for use on carpet only
 Applicable on:
 Asari Chair by Herman Miller™
 New Aeron® Chairs
 Caper® Chairs
 Embody® Chairs
 Fuld Nesting Chairs
 Lino™ Chairs
 Mirra® 2 Chairs
 Sayl Chairs Verus™ Chairs

BSC Caster

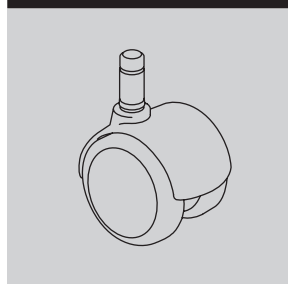

2-inch-diameter double-wheel caster; black nylon wheels and hood; soft polyurethane tread; for use on hard floors or carpet
 Applicable on:
 Eames® Aluminum Group

C9 Caster

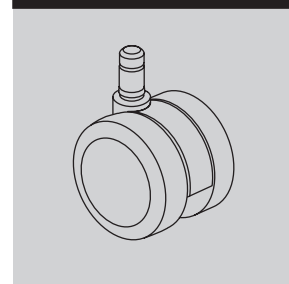

2¹/₂-inch-diameter double-wheel caster; black nylon wheels and yoke; soft polyurethane tread; internal brake; for use on hard floors or carpet
 Applicable on:
 Caper Chairs
 Embody Chairs
 Lino Chairs
 Mirra 2 Chairs
 Sayl Chairs
 Setu Chairs
 Verus Chairs

49 Caster

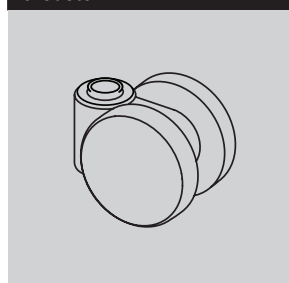

1⁷/₈-inch-diameter soft double-wheel caster; black nylon wheels and yoke; for use on hard floors or carpet
 Applicable on:
 Sayl Chairs

BKS Caster

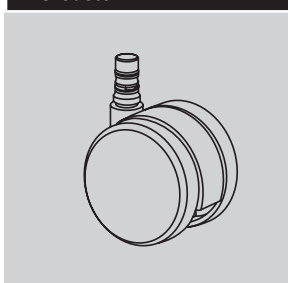

2¹/₂-inch-diameter hard double-wheel caster; black yoke; quiet roll technology; for use on carpet only
 Applicable on:
 Cosm™ Chairs

C7 Caster

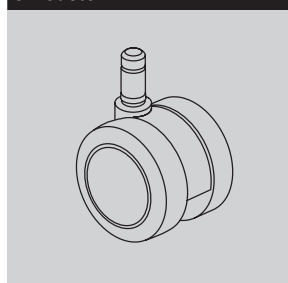

2¹/₂-inch-diameter double-wheel caster; black nylon wheels and yoke; soft polyurethane tread; for use on hard floors or carpet
 Applicable on:
 Asari Chair by Herman Miller™
 New Aeron Chairs
 Caper Chairs
 Embody Chairs
 Fuld Nesting Chairs
 Lino Chairs Sayl Chairs
 Mirra 2 Chairs Verus Chairs

CSQ Caster

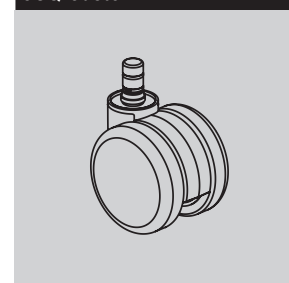

2¹/₂-inch-diameter double-wheel caster; color-matched nylon wheels and yoke; soft polyurethane tread; for use on hard floors or carpet
 Applicable on:
 Zeph® Chairs

Casters and Glides

continued

GSA

DC1 Caster

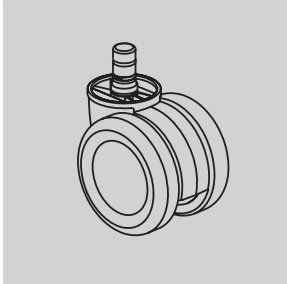

2 1/2-inch-diameter double-wheel braking caster; black nylon wheels and yoke; for use on hard floors or carpet; quiet roll technology

Applicable on:

New Aeron Chairs

H9 Caster

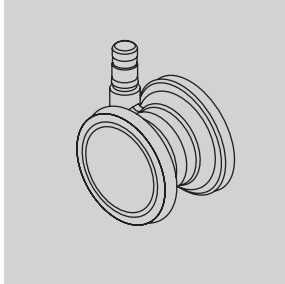

2 1/2-inch-diameter double-wheel caster; clear polycarbonate wheels; nylon yoke; soft polyurethane tread; for use on carpet only.

Applicable on:

Embody Chairs

MD Caster

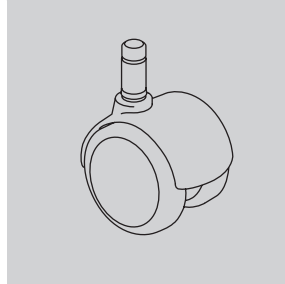

2-inch-diameter double-wheel caster; black nylon wheels with integral chrome hood; soft polyurethane tread; for use on hard floors or carpet

Applicable on:

Eames® Aluminum Group

SC8 Caster

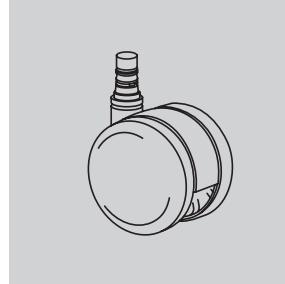

2 1/2-inch-diameter double-wheel caster; black nylon wheels and yoke; soft polyurethane tread; quiet roll technology; for use on hard floors or carpet

Applicable on:

Cosm Chairs

Fuld Nesting Chairs

Lino Chairs

Mirra 2 Chairs

Verus Chairs

DS Caster

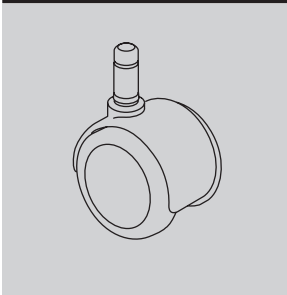

2-inch-diameter soft double-wheel braking caster; black nylon wheels and hood; for use on hard floors only

Applicable on:

Aside® Chairs

Caper Chairs

HCC Caster

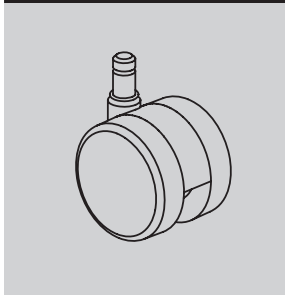

2 1/2-inch-diameter double-wheel low roll resistance caster; black yoke; for use on hard floors or carpet.

Applicable on:

Setu Chairs

OC Caster

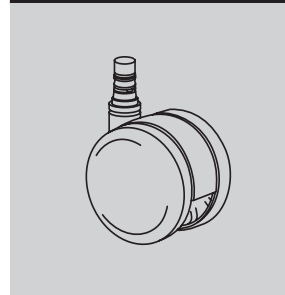

2 1/2-inch-diameter double-wheel medium roll-resistant caster; black nylon wheels and yoke; soft polyurethane tread; for use on hard floors or carpet; quiet roll technology

Applicable on:

Cosm Chairs

Fuld Nesting Chairs

Setu Chairs

U4 Caster

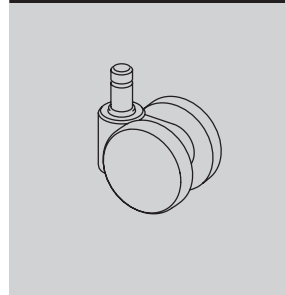

1 7/8-inch-diameter hard double-wheel caster; black nylon wheels and yoke; for use on carpet only

Applicable on:

Aside Chairs

Verus Chairs

Casters and Glides

continued

GSA

U5 Caster

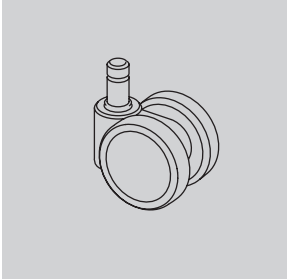

1⁷/₈-inch-diameter soft double-wheel caster; black nylon wheels and yoke; for use on hard floors or carpet

Applicable on:

Aside Chairs
Caper Chairs
Verus Chairs

VD Caster

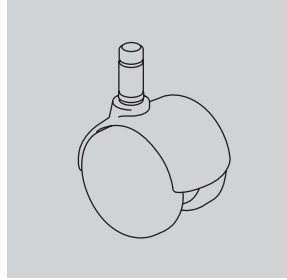

2-inch-diameter hard double-wheel caster; black nylon wheels with integral chrome hood; for use on carpet only

Applicable on:

Eames Aluminum Group

69 Glide

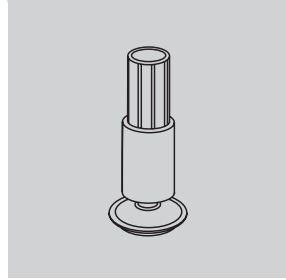

(Front glide shown)

2¹/₈-inch-high glide; black glass-filled nylon stem; steel-plated swivel foot with Floor Saver Glide® insert; for use on hard floors only

Applicable on:

Sayl Chairs

GD Glide

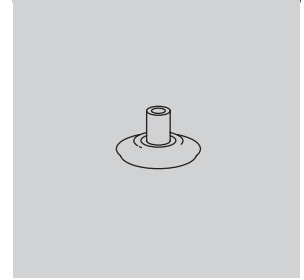

1¹/₂-inch-diameter glide; 1/2 inch in height; black nylon; for use on hard floors or carpet

Applicable on:

Eames Aluminum Group

UD Caster

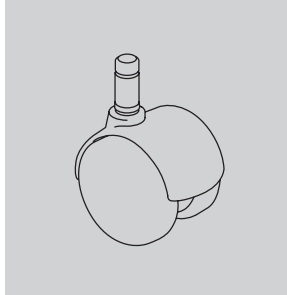

2-inch-diameter hard double-wheel caster; black nylon wheels with painted hood; for use on carpet only

Applicable on:

Eames® Aluminum Group

16 Glide

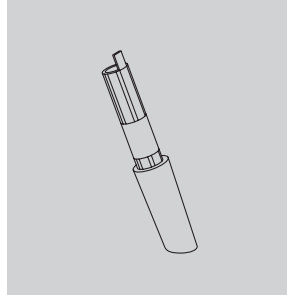

(Front glide shown)

2¹/₈-inch-high glide; black or fog acetal; for use on carpet only

Applicable on:

Sayl Chairs

G4 Glide

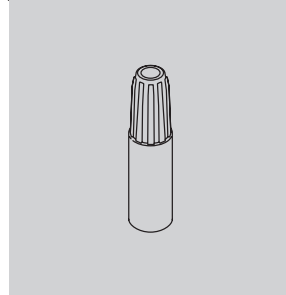

1⁷/₈-inch-high glide; black acetal; for use on carpet only

Applicable on:

Verus Chairs

GF Glide

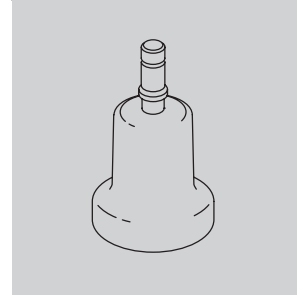

2¹/₂-inch-high glide; black nylon; for use on hard floors or carpet

Applicable on:

New Aeron Chairs
Caper Chairs
Cosm Chairs
Lino Chairs
Mirra 2 Chairs
Sayl Chairs
Verus Chairs

Casters and Glides

continued

GSA

GFG Glide

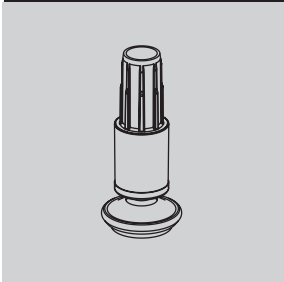

Floor Saver Glide™ insert; for use on hard floors only

Applicable on:
Zeph Chairs

GLN Glide

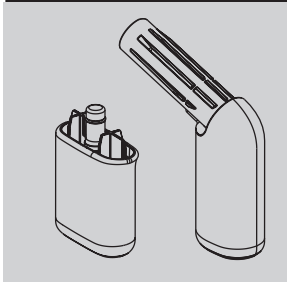

Acetal glide; for use on carpet only

Applicable on:
Fuld Nesting Chairs

HG Glide

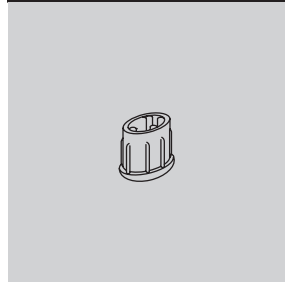

1/2-inch-high glide; black nylon glide with stainless-steel insert;

for use on hard floors or carpet
Applicable on:
Aside Chairs

X8 Glide

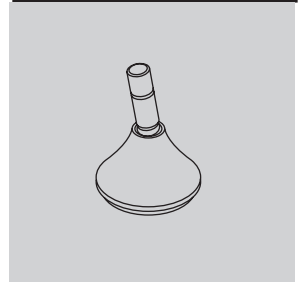

Glide; low profile; for use on hard floors or carpet

Applicable on:
Setu Chairs

GL Glide

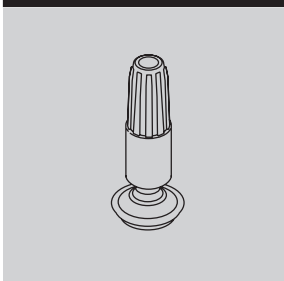

1 7/8-inch-high glide; black nylon stem; steel-plated swivel foot with Floor Saver Glide® insert; for use on hard floors only

Applicable on:
Verus Chairs

GNB Glide

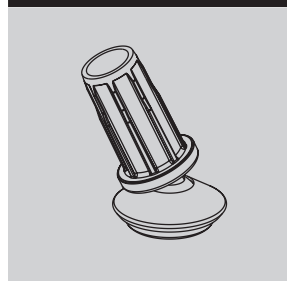

Swivel glide; nylon base; for use on carpet only

Applicable on:
Zeph Chairs

SG Glide (for Aside)

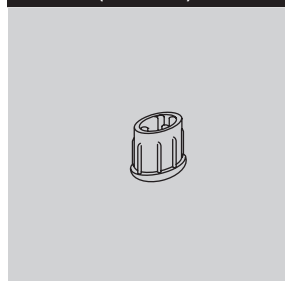

1/2-inch-high glide; black nylon; for use on carpet only

Applicable on:
Aside Chairs

XS Glide

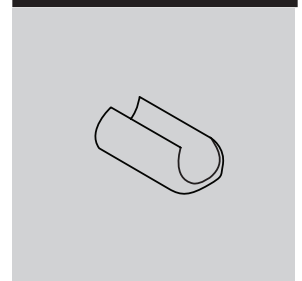

1/8-inch-high glide; polycarbonate in black, fog, clear, and studio white finishes; for use on hard floors or carpet

Applicable on:
Sayl Chairs

Casters and Glides

continued

GSA

Y7 Glide

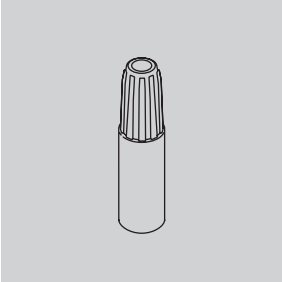

$1\frac{7}{8}$ -inch-high glide; black
acetal; for use on carpet only

Applicable on:
Caper Chairs

YX Glide

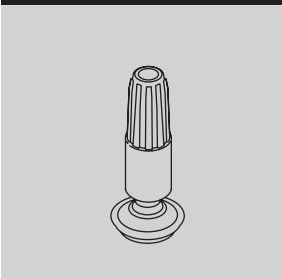

$1\frac{7}{8}$ -inch-high glide; black nylon
stem; steel-plated
swivel foot with Floor Saver
Glide® insert; for use on
hard floors only

Applicable on:
Caper Chairs

For more information about our products and services or to see a list of dealers, please visit us at HermanMiller.com or call (800) 851 1196.

© 2026 Herman Miller, Inc., Zeeland, Michigan

Distribution Rights

Working together since 1956, Herman Miller and Vitra are the authentic sources of designs by Charles and Ray Eames, Alexander Girard, and George Nelson. All the designs shown in this book are protected by law. Herman Miller has obtained all rights to make and sell these designs. Also, Herman Miller holds exclusive worldwide manufacturing and distribution rights for these products with the following exceptions:

Charles and Ray Eames, George Nelson, and Alexander Girard—
Worldwide distribution rights for furniture in all areas except Europe and the Middle East. For those areas, please contact Vitra.

Isamu Noguchi—Worldwide distribution rights for the Noguchi Rudder Table. Distribution rights for the Noguchi Table in North America and Central America only. For all other areas, please contact Vitra.

Magis—Exclusive distribution rights in the US and Canada. For all other areas, please contact Magis.

© **HermanMiller**, , Action Office, Aeron, Aside, Canvas Office Landscape, Caper, Cosm, Co/Struc, Eames, Embody, Ethospace, Exclave, Fine-Tune, FlexFront, Formcoat, Ground Cloth, Intent, Layout Studio, Lino, Maharam, Meridian, Mirra, Motia, Nelson, Pellicle, Perspectives, Plex, PostureFit, PostureFit SL, Sayl, Setu, Tu, Verus, Y-Tower and Zeph are among the registered trademarks of Herman Miller, Inc., and its owned subsidiaries.

™ AireWeave, Bubbletack, Canvas Vista, Cellular Suspension, Commend, Compass, Connect, DOT, Durawrap, Everywhere, Flex-Edge, Headway, Hopsak 2, Iota, Keyless Entry, Latitude, Lyris 2, Mora, Multiscrim, Nevi, OE1, OE1 Workspace Collection, Overlay, Renew, Stackable, Swoop, Thrive, TriFlex, Twist and Valor are among the trademarks of Herman Miller, Inc., and its owned subsidiaries.

Chemsurf® is a registered trademark of Wilsonart International.

Corian® is a registered trademark of E.I. du Pont de Nemours and Company Corporation.

FLEXNET™ is a trademark of Milliken & Company.

Floor Saver Glide® is a registered trademark of Carpin Manufacturing, Inc.

Forest Stewardship Council® is a registered trademark of the Forest Stewardship Council A.C. (FSC). We are FSC® certified (FSC® C102895).

FSC® is a registered trademark of the Forest Stewardship Council A.C. (FSC).

MicrobeCare™ is a trademark of Parasol Medical LLC.

Microsoft® and Natural® Keyboard are registered trademarks of Microsoft Corporation.

Place Textiles® is a registered trademark of Place Textiles.