



GSA prices effective April 2, 2018
(based on February 6, 2017, commercial price list)
Published April 2018

Storage Systems

Meridian® Vertical Files

General Services Administration Federal Supply Service Authorized Federal Supply Schedule Price List

Online access to contract ordering information, terms and conditions, up-to-date pricing, and the option to create an electronic delivery order is available through GSA Advantage!, a menu-driven database system. The Internet address for GSA Advantage! is www.gsaadvantage.gov.

Office Furniture
FSC Group 71, Part 1
Contract Number: GS-03F-036DA
Contract Period: December 21, 2015—December 20, 2020

Herman Miller, Inc.
855 East Main Avenue
Zeeland, Michigan 49464
(616) 654 3000 Phone
(616) 654 8278 Fax
www.HermanMiller.com/government

Business Size: Large

Contract Information

1a. Special Item Numbers (SIN)

SIN 71-1

Packaged Offices

SIN 711-1

Furniture Systems

SIN 711-2

Computer Furniture

SIN 711-3

Filing and Storage Cabinets

SIN 711-11

Tables and Accessories

SIN 711-16

Upholstered Seating

SIN 711-18

Multi-Purpose Seating

SIN 711-91

Project Management

Services under this SIN may be used only in conjunction with the purchase of new furniture. Please contact your local Herman Miller representative to discuss the available labor categories (listed below). The hourly rates listed are "Not To Exceed" or "NTE" values.

Furniture Project Manager: \$64.75 per hour

Furniture Project Coordinator: \$49.00 per hour

Build-Out Project Manager: \$80.00 per hour

SIN 711-93

Reconfiguration and Relocation Services

Reconfiguration and Relocation Services will be provided by Herman Miller, Inc., or its participating dealer based on a fee not to exceed \$55 per hour, which applies to services totaling \$150,000 (per SIN) and below only. Services above \$150,000 shall be negotiated on a case-by-case basis. This SIN may only be used with the purchase of new product under SIN 711-1.

See * Additional Notes for Installation & Reconfiguration and Relocation Services.

SIN 711-94

Design/Layout

Design service will be provided by Herman Miller, Inc., or its participating dealer based on a fee not to exceed \$65 per hour.

SIN 711-95

Installation Services

Installation Services will be provided by Herman Miller, Inc., or its participating dealer based on a fee not to exceed \$55 per hour (\$82.50 per hour for after-hours Installation), which applies to services totaling \$150,000 (per SIN) and below only. Services above \$150,000 shall be negotiated on a case-by-case basis.

See * Additional Notes for Installation & Reconfiguration and Relocation Services.

* Additional Notes for Installation & Reconfiguration and Relocation Services:

FOB Destination (Drop Ship): Price includes product delivery to the site, brought to the tailgate of the truck. The purchaser is responsible for unloading.

Prices effective up to the maximum order by SIN only. Above the MO, pricing shall be negotiated on a case-by-case basis between the client and local dealer.

Standard Services are Subject to the Following Conditions:

Installation will be performed during normal weekday working hours.

Adequate facilities for delivery, unloading, moving and staging/ storing the product during the installation process shall be provided.

Service work will not be hindered by other trades.

Electric, heat, and adequate elevator service will be furnished without charge.

The immediate installation area shall be complete and free of debris including the carpet/flooring before installation commences.

Any work requiring a licensed electrician is the responsibility of the buyer.

Additional Charges May Apply For:

Major Metro Markets and any non-ground floor installation.

Major Metro Markets include large population centers and urban environments.

Installation in a clinical/medical environment.

Special restrictions or limits established by local laws, ordinances or the directions of the buyer, including but not limited to restrictions on transportations of materials, street access to the job site and/or dock facilities.

Installations outside of a 50 mile radius of the servicing dealer.

Local Prevailing Wage and/or Union Labor Rates.

Any additional charges shall be quoted by the dealer and approved by the buyer prior to performance of the work.

SIN 711-96

Leasing

Contact Herman Miller participating government dealer for current leasing information.

SIN 711-99

New Product Introductions

Contract Information

continued

SIN 711-500

Order-Level Materials (OLMs)

This SIN is only for products and/or services used in direct support of the purchase of new furniture. It requires approval from the ordering Contract Officer. Please contact your local Herman Miller representative to discuss the appropriate use of this SIN.

1b. Lowest Priced Model

SIN 711-1:	G9999.B	\$7
SIN 711-2:	6-5-D	\$35
SIN 711-3:	9M10018	\$14
SIN 711-11:	DT9A.	\$36
SIN 711-16:	OA401	\$41
SIN 711-18:	AS90598	\$46
SIN 711-99:	R1366	\$27

1c. Not applicable

2. Maximum Order

SIN 711-1, SIN 711-2
\$500,000 net product value

SIN 711-3, SIN 711-11
\$300,000 net product value

SIN 711-16, SIN 711-18
\$200,000 net product value

SIN 711-93
\$150,000

SIN 711-94
\$150,000

SIN 711-95
\$150,000

SIN 711-96
\$500,000 net product value

SIN 711-99
\$50,000 net product value

SIN 711-500
\$100,000

3. Minimum Order

\$100 net

4. Geographic Coverage

Continental U.S.

Orders for Alaska, Hawaii, and Puerto Rico will be shipped F.O.B. inland carrier point of exportation.

5. Point of Production

Zeeland, Ottawa County, Michigan
Spring Lake, Ottawa County, Michigan

6. Pricing

Prices shown are list. Discounts include Industrial Funding Fee.

SIN 711-1

Product: Selected Action Office 1, Action Office 2, C-Style Overhead Storage, Ethospace System, Quadrant Pedestals, Supplemental Products, Tu Pedestals and Pedastools, and approved Herman Miller Options Products.

Standard Lead Time	Single Order Net Purchase	Discount From list
	\$100 - 250,000	73.8%
	\$250,001 - 500,000	76.8%

SIN 711-1

Product: Selected Nevi™ Tables, Renew™ Tables, Renew Link and approved Herman Miller Options Products

Standard Lead Time	Single Order Net Purchase	Discount From List
	\$100 - 500,000	73.8%

SIN 711-1

Product: Selected Motia™ Tables, and approved Herman Miller Options Products

Standard Lead Time	Single Order Net Purchase	Discount From List
	\$100 - 500,000	73.8%

SIN 711-1

Product: Tu Wood Pedestals and approved Herman Miller Options Products

Standard Lead Time	Single Order Net Purchase	Discount From List
	\$100 - 300,000	74.3%

SIN 711-1

Product: Selected Canvas Office Landscape and approved Herman Miller Options Products

Standard Lead Time	Single Order Net Purchase	Discount From List
	\$100 - 500,000	74.8%

Contract Information

continued

SIN 711-1

Product: Selected Layout Studio® and approved Herman Miller Options Products

Standard Lead Time	Single Order Net Purchase	Discount From List
	\$100 - 500,000	60.7%

SIN 711-1

Product: Selected Meridian Pedestals, Meridian Pedastools, and approved Herman Miller Options Products

Standard Lead Time	Single Order Net Purchase	Discount From List
	\$100 - 500,000	64.2%

SIN 711-1

Product: Selected Thrive Portfolio and approved Herman Miller Options Products

Standard Lead Time	Single Order Net Purchase	Discount From List
	\$100 - 250,000	62%
	\$250,001 - 500,000	66.4%

SIN 711-2

Product: Passage Desking System and approved Herman Miller Options Products

Standard Lead Time	Single Order Net Purchase	Discount From List
	\$100 - 500,000	56.7%

SIN 711-2

Product: 5000 Series Furniture and approved Herman Miller Options Products

Standard Lead Time	Single Order Net Purchase	Discount From List
	\$100 - 500,000	58.7%

SIN 711-3

Product: Meridian Laterals, Verticals, Towers, and Storage products and approved Herman Miller Options Products

Standard Lead Time	Single Order Net Purchase	Discount From List	Towers & Storage
	\$100 - 300,000	67.3%	62.7%
		66.3%	

SIN 711-3

Product: Tu Lateral Files, Tu Storage, Tu Towers, Tu Wood Cases, Tu Wood Cubbies, Tu Wood Credenzas, Tu Wood Towers, and approved Herman Miller Options Products

Standard Lead Time	Single Order Net Purchase	Discount From List
	\$100 - 300,000	74.3%

SIN 711-11

Product: Selected Tables and Accessories and approved Herman Miller Options Products

Standard Lead Time	Single Order Net Purchase	Discount From List
Avive® Tables	\$100 - 250,000	72.8%
	\$250,001 - 500,000	74.8%
Herman Miller Eames® Tables	\$100 - 250,000	73.6%
	\$250,001 - 300,000	77.6%
Everywhere™ Tables	\$100 - 300,000	72.8%

SIN 711-16

Product: Swoop upholstered seating products and approved Herman Miller Options Products

Standard Lead Time	Single Order Net Purchase	Discount From List
Plex Lounge Furniture	\$100 - 200,000	59.5%
Swoop™	\$100 - 200,000	60.7%

SIN 711-18

Product: Selected Seating and approved Herman Miller Options Products

Standard Lead Time	Single Order Net Purchase	Discount From List
Aeron® (Classic and New)	\$100 - 200,000	64.5%
Aside®	\$100 - 200,000	64.2%
Caper®	\$100 - 200,000	61.5%
Celle®	\$100 - 200,000	59.7%
Cosm™	\$100 - 200,000	61.7%
Embody®	\$100 - 200,000	59.7%
Equa 2®	\$100 - 200,000	65.8%
Ergon 3®	\$100 - 200,000	68.8%
Keyn	\$100 - 200,000	57.7%
Lino™	\$100 - 200,000	63.7%
Mirra® 2	\$100 - 200,000	61.7%
Sayl®	\$100 - 200,000	62.2%
Setu®	\$100 - 200,000	59.7%
Verus™	\$100 - 200,000	63.7%

SIN 711-99

Product: Selected Exclave™, Locale®, Public Office Landscape®, Resolve® System, and approved Herman Miller Options Products

Standard Lead Time	Single Order Net Purchase	Discount From List
Exclave	\$100 - 50,000	61.7%
Locale	\$100 - 50,000	63.7%
Public Office Landscape	\$100 - 50,000	61.7%
Resolve System	\$100 - 50,000	69.8%
Intent Solution	\$100 - 50,000	58.7%

Contract Information

continued

7. Quantity Discounts

Reference item #6.

8. Payment Term

Net 30 days

9. Government Commercial Credit Card

- a. Government commercial credit cards are accepted below the micropurchase threshold.
- b. Government commercial credit cards are accepted above the micropurchase threshold.

10. Foreign Items

None

11. Time of Delivery

- a. 90 day ARO
- b. Expedited delivery: Items listed in the 10-Day section of the catalogs are available for expedited delivery.
- c. Overnight/2-day delivery: Select items may be available for overnight or 2-day delivery. Contact Herman Miller or a participating dealer for availability and rates.
- d. Urgent requirements: Agencies may contact contractor or participating dealer to request faster delivery.

12. F.O.B.

F.O.B. destination except Alaska, Hawaii, and Puerto Rico, which will be shipped F.O.B. inland carrier point of exportation.

13. Ordering Address

- a. Herman Miller, Inc.,
Government Customer Care 0161
855 East Main Avenue
Zeeland MI 49464.
- b. For supplies and services, the ordering procedures information on Blanket Purchase Agreements (BPA's) and a sample BPA can be found at the GSA/FSS Schedule homepage (www.fss.gsa.gov/schedules).

14. Payment Address.

Herman Miller, Inc.
22764 Network Place
Chicago, IL 60673-1227

15. Warranty

Herman Miller, Inc., commercial warranty applies.

16. Export Packing Charge

Prices supplied on request.

17. Terms and Conditions of Government Purchase Card Acceptance (any thresholds above the micropurchase level)

None.

18. Rental Maintenance and Repair Terms

Not applicable

19. Terms and Conditions of Installation

Installation Services will be provided by Herman Miller, Inc., or its participating dealer based on a fee not to exceed \$55 per hour (\$82.50 per hour for after-hours Installation), which applies to services totaling \$150,000 (per SIN) and below only. Services above \$150,000 shall be negotiated on a case-by-case basis.

Additional Notes for Installation & Reconfiguration and Relocation Services:

FOB Destination (Drop Ship): Price includes product delivery to the site, brought to the tailgate of the truck. The purchaser is responsible for unloading.

Prices effective up to the maximum order by SIN only. Above the MO, pricing shall be negotiated on a case-by-case basis between the client and local dealer.

Standard Services are Subject to the Following Conditions:

Installation will be performed during normal weekday working hours.

Adequate facilities for delivery, unloading, moving and staging/storing the product during the installation process shall be provided.

Service work will not be hindered by other trades.

Electric, heat, and adequate elevator service will be furnished without charge.

The immediate installation area shall be complete and free of debris including the carpet/flooring before installation commences.

Any work requiring a licensed electrician is the responsibility of the buyer.

Additional Charges May Apply For:

Major Metro Markets and any non-ground floor installation.

Major Metro Markets include large population centers and urban environments.

Installation in a clinical/medical environment.

Special restrictions or limits established by local laws, ordinances or the directions of the buyer, including but not limited to restrictions on transportations of materials, street access to the job site and/or dock facilities.

Installations outside of a 50 mile radius of the servicing dealer.

Local Prevailing Wage and/or Union Labor Rates.

Any additional charges shall be quoted by the dealer and approved by the buyer prior to performance of the work.

Contract Information

continued

20. Terms and Conditions of Repair Parts

Not applicable

21. Service and Distribution Points

For service and distribution points nearest you, call (800) 851 1196.

22. Participating Dealers

Access Herman Miller web site for current list of participating dealers: www.HermanMiller.com/government.

23. Preventive Maintenance

Not applicable

24a. Special Attributes.

2018

For the 11th consecutive year, Herman Miller received a perfect score on the Corporate Equality Index and we were designated as Best Place to Work for LGBT equality. This report evaluates U.S. companies in terms of diversity, particularly their LGBT-related policies and practices.

2017

Herman Miller was named the 2017 "Corporation of the Year" in the consumer products sector by the Michigan Minority Supplier Development Council (MMSDC).

Herman Miller has received a 2017 SEAL (Sustainability, Environmental Achievement and Leadership) Business Sustainability Award.

Herman Miller has earned the 4 Star Diversity Visionary Award. This award celebrates the diversity, equality, and inclusion work of Herman Miller. The award is presented at the annual Diversity Equity Inclusion Summit, held by the Grand Rapids Area Chamber of Commerce.

Herman Miller named one of the Best and Brightest in Wellness for the fifth year in a row.

Working Mother magazine has recognized Herman Miller as one of the 2017 Working Mother 100 Best Companies.

Herman Miller earned our tenth consecutive perfect score in Human Rights Campaign (HRC) Foundation's 2017 Corporate Equality Index.

As one of the top-scoring companies in our industry for the thirteenth consecutive year, Herman Miller has qualified for inclusion in RobecoSAM's 2017 Sustainability Yearbook and received the Bronze Class distinction for our excellent economic, environmental, and social sustainability performance.

Herman Miller has once again earned the WorldatWork Seal of Distinction, a unique standard of excellence in work-life effectiveness that shows we provide a distinct, mutually beneficial workplace experience.

2016

Herman Miller was recognized as the Business of the Year at the Annual Meeting of the West Michigan Environmental Action Council (WMEAC). This award goes to the business with the greatest depth and breadth of support, unwavering dedication to environmental action in West Michigan, and a strong corporate commitment to environmental advocacy.

The 101 Best and Brightest Sustainable Companies once again (fifth consecutive year) recognized Herman Miller as an organization in Michigan (and for the first time, in the nation) that exhibits leadership and innovation in its approach to sustainability.

Herman Miller has been recognized by the Michigan Minority Supplier Development Council (MMSDC), as a "Corporation of the Year", and we also received a "2016 Excellence in Supplier Diversity Award" from the Great Lakes Women's Business Council. Additionally, we are the only West Michigan company this year to receive an "Ambassadors Championing Excellence" Award from the MMSDC.

Plex Lounge Furniture from Herman Miller receives #MetropolisLikes award at NeoCon 2016.

Plex Lounge Furniture from Herman Miller receives Interior Design HiP Award for Workplace Seating/Lounge at NeoCon 2016.

Spot Stools from Herman Miller Collection receive Interior Design HiP Award for Hospitality Seating at NeoCon 2016.

Herman Miller has been named a 2020 Women on Boards Winning Company. Companies selected for this recognition are considered champions of board diversity as 20 percent or more of their board seats are occupied by women.

Herman Miller selected for inclusion in the 2016 RobecoSAM Sustainability Yearbook for twelfth consecutive year.

Herman Miller again earns the WorldatWork Work-Life 2016 Seal of Distinction. This award identifies organizations that focus on programs that promote work-life balance and overall well-being.

2015

Herman Miller earns ninth consecutive perfect score in Human Rights Campaign (HRC) Foundation's 2016 Corporate Equality Index and we were designated as Best Place to Work for LGBT equality.

This is the fourth consecutive year that Herman Miller was named one of Michigan's Best and Brightest Sustainable Companies.

Herman Miller has received the Best and Brightest in Wellness Award for the third year in a row. This program is an innovative initiative that recognizes and celebrates quality and excellence in health awareness.

Contract Information

continued

Herman Miller received the Forest Stewardship Council (FSC) Leadership Award for longstanding commitment to manufacturing with wood sourced from responsibly managed forests, which reduces environmental impacts by protecting against deforestation and forest degradation.

Herman Miller accepted its second Excellence in Reusable Packaging Award from the Reusable Packaging Association.

Herman Miller has once again been recognized for its commitment to best-in-class economic, environmental, and societal sustainability, earning a spot on the prestigious Dow Jones Sustainability Index (DJSI) for the twelfth consecutive year. We are the only contract furniture company recognized globally for its corporate sustainability leadership.

Herman Miller selected for inclusion in the 2015 RobecoSAM Sustainability Yearbook; awarded Bronze Class distinction for excellent sustainability performance for the second consecutive year.

Herman Miller received a Michigan Business Pollution Prevention (MBP₃) Certificate – a recognition given by the Michigan Department of Environmental Quality (MDEQ) to organizations committed to environmental stewardship, conservation, and sustainable operations. This basic partnership with the MDEQ, which we've maintained since 1998, makes us eligible for our Clean Corporate Citizen (CCC) status that began in 2004 and our Environmental Leader status, which we received for the first time this past year.

MedAssets named Herman Miller Healthcare as Platinum Suppliers. MedAssets, a large group purchasing organization, helps providers enhance operational and financial performance so they can sustainably serve the needs of their community.

Herman Miller honored with five of 20 spots for the Michigan Environmental Leaders Award by the Michigan Department of Environmental Quality for our outstanding, voluntary environmental stewardship.

Renew Sit-to-Stand tables recognized on Record Products 2014 list by Architectural Record.

Herman Miller was again awarded a perfect score in the 2015 Corporate Equality Index. This is the eighth consecutive year we received a perfect score.

2014

Herman Miller has received the Best and Brightest in Wellness Award for the second year in a row. This program is an innovative initiative that recognizes and celebrates quality and excellence in health awareness.

Herman Miller's Locale wins International Design Excellence Awards (IDEA) Gold in the Office & Productivity category.

Herman Miller achieves eleventh consecutive listing on Dow Jones Sustainability World Index, an international stock portfolio that evaluates the annual performance of the world's largest 2500 companies using economic, environmental, and social criteria, known as the "triple bottom line" of sustainability.

2013

Herman Miller achieves tenth consecutive listing on Dow Jones Sustainability World Index.

Herman Miller has received the Best and Brightest in Wellness Award. This program is an innovative initiative that recognizes and celebrates quality and excellence in health awareness.

Herman Miller Earns Perfect Score on the Corporate Equality Index. We are one of only 303 major U.S. businesses to receive a perfect score in 2013, an achievement we have now obtained seven years in a row.

Herman Miller is listed in Forbes Magazine inaugural "Platinum List" of America's 400 best managed, large companies.

For the second consecutive year, Herman Miller is honored as one of West Michigan's "101 Best and Brightest Sustainable Companies".

2012

Herman Miller accepted its first Excellence in Reusable Packaging Award from the Reusable Packaging Association.

Herman Miller is named "Corporation of the Year" in the commercial products sector by the Michigan Minority Supplier Development Council.

In July 2012 Herman Miller was inducted into the Made in the USA Hall of Fame. Herman Miller is one of only 20 companies across the nation to receive this distinction.

Herman Miller achieves ninth consecutive listing on Dow Jones Sustainability World Index.

Herman Miller is honored as one of West Michigan's 101 Best and Brightest Sustainable Companies.

The Sustainable Asset Management (SAM) group selected Herman Miller for inclusion in "The Sustainability Yearbook 2012" and has awarded Herman Miller both the "SAM Sector Leader" and "SAM Sector Mover" distinctions.

Herman Miller was named one of 16 Section Leaders on Climate Counts 2011-2012 Scorecard Report, making us the industry leader for Home and office Furnishings.

SGS International Certification Services, Inc., recognizes Herman Miller's manufacturing sites, Midwest Distribution Center, and Design Yard for initial certification to the OHSAS 18001 standard as well as re-certification to ISO 14001.

Contract Information

continued

2011

Trust Across America, a company dedicated to unraveling the complexities of trustworthy business behavior, listed Herman Miller as one of their “Top Ten Most Trustworthy Companies in America 2011.”

The U.S. Environmental Protection Agency (EPA) selected Herman Miller, as a WasteWise Gold Achievement—Climate Change winner.

Herman Miller achieves eighth consecutive listing on Dow Jones Sustainability World Index, an international stock portfolio that evaluates the annual performance of the world’s largest 2500 companies using economic, environmental, and social criteria, known as the “triple bottom line” of sustainability.

The Michigan Minority Supplier Development Council (MMSDC) named Herman Miller as its “Corporation of the Year” in the commercial products sector. This was the fifth time Herman Miller has received this award since 2005.

Herman Miller accepted its third Neighborhood Environmental Partners (NEP) award from the Michigan Department of Natural Resources and Environment.

Herman Miller receives the Reader’s Choice award from TreeHugger’s Best of Green: Design and Architecture category for the SAYL chair.

Herman Miller earns Citibank’s Global Environmental Vendor of the Year award.

The SAYL chair from Herman Miller was dubbed the “Product Design of the Year” from the 2010 International Design Awards (IDA) jury.

Herman Miller Healthcare’s Compass system was awarded a 2011 Medical Design Excellence Award (MDEA) for its research-based design and ability to be used in a variety of healing spaces, while simultaneously improving the overall delivery of healthcare.

The Sustainable Asset Management (SAM) Group selected Herman Miller for inclusion in the “Sustainability Yearbook 2011” and awarded us both the “SAM Sector Leader” and “SAM Sector Mover” distinctions.

Herman Miller has received the top rating for a fourth consecutive year in the Human Rights Campaign (HRC) Foundation’s eighth annual Corporate Equality Index. The “Best Places to Work for LGBT Equality” distinction is awarded to businesses that scored 100% on the HRC Foundation’s 2011 Corporate Equality Index.

Herman Miller again tops contract furniture industry in FORTUNE’s “Most Admired” Companies survey. For the 23rd time in 25 years.

2010

The NASDAQ OMX CRD Global Sustainability Index (QCRD) has included Herman Miller among their top 100 companies in the world.

Herman Miller achieves seventh consecutive listing on Dow Jones Sustainability World Index, an international stock portfolio that evaluates the annual performance of the world’s largest 2500 companies using economic, environmental, and social criteria, known as the “triple bottom line” of sustainability. Herman Miller is one of approximately 300 companies worldwide and the only contract office furniture manufacturer, selected for this index.

Herman Miller has been recognized by Fast Company magazine as one of its 2010 Most Innovative Companies and among the more select Innovation All-Stars.

The U.S. Environmental Protection Agency’s Office of Resource Conservation and Recovery has selected Herman Miller to receive the 2010 WasteWise Gold Achievement Award for Green Purchasing.

The Michigan Department of Natural Resources and Environment (MDNRE) has recognized Herman Miller’s West Michigan manufacturing sites and Midwest Distribution Center as continuing Clean Corporate Citizens.

Herman Miller makes the U.S. Environmental Protection Agency’s (EPA) list of the top fifty users of renewable electricity, of more than 1,200 organizations participating in the Green Power Partnership. This is the second consecutive time Herman Miller was recognized. Herman Miller was the only furniture manufacturer on the list.

Herman Miller accepted its second Neighborhood Environmental Partners (NEP) award from the Michigan Department of Natural Resources and Environment.

For the 22nd time in 24 years, Herman Miller was awarded the No. 1 industry ranking in a survey among the executives and board members of peer companies and independent industry analysts, as published in FORTUNE magazine’s annual “Most Admired” companies feature.

The Michigan Department of Environmental Quality (MDEQ) recognizes Herman Miller’s GreenHouse as one of Michigan’s top environmental performers with a Clean Corporate Citizen (C3) longevity award. This recognizes that the GreenHouse has maintained its C3 designation for the past five years.

For the third year in a row, Herman Miller makes FORTUNE magazine’s “100 Best Companies to Work For” list. Herman Miller is one of only three Michigan-based companies to make the list.

24b. Section 508 Compliance

Not applicable

25. Data Universal Numbering System (DUNS): 00-601-2801

26. Registered in System for Award Management (www.SAM.gov) Database

27. Cancellation

Prior to production, no cancellation charge will apply. After production, only actual cost incurred that the contractor can demonstrate if items are sold after 3 months.

28. Restocking Charges

Agencies must notify the contractor for authorization prior to returning any items. The customer agency will be required to pay all packaging and return freight charges. A restocking fee of 50% for Systems Furniture and 35% for all other product lines will be charged for any returned items.

Herman Miller Miscellaneous Information:

Federal ID Number: 38-0837640

Commercial and Government Entity Code (CAGE): 40636

Data Universal Numbering System (DUNS) 00-601-2801

Commercial Entity Code (CEC): 00702290J

Introduction	page 2
Meridian® Vertical Files	3
Vertical Files	5
Vertical File Accessories	15
Indices	21
By Name	21
By Number	23
Appendices	
20-Day or Less/Assigned Lead-Time Order Information	
Keyed-Alike Information	
Stain-to-Match Program	
For the latest materials information, refer to the Materials pages on HermanMiller.com.	

Introduction

A Note on the Organization of This Book

There are a few signals that will help you understand the organization of this book. Once you know them, you should be able to find your way around easily.

Like a newspaper, this book is formatted with columns of text and illustrations that run vertically.

Information wraps from one column to the next and continues for as many pages as it needs to.

Black bars are clues.

A black bar at the top of a page signals the start of information about a product.

This information is divided into two sections, each signaled by a black bar. Product Information includes a description, additional notes, and dimensional drawings. Specification Information, which always begins at the top of a column, includes a series of steps. Each step represents a decision you need to make in order to complete your product number. Steps must be followed sequentially. The number of pages needed to complete information on a product varies; some will be complete in one page; others may fill three or four pages. Just continue going through the steps until you run into the next product, signaled by the black bar at the top of the page.

Black tabs running along the outside edge of the page help you locate what section you are in or what section you want to go to. You can thumb forwards or backwards to find a section; tabs and text appear on both sides of the page.

The additional pages in the back of the book include the appendices and indices. They are signaled by a long black bar running along the outside edge of the page.

The index is presented two ways.

The first index is in alphabetical order by product name. It can be helpful if you are new to the products and numbering scheme or if you are looking for a type of product, such as work chair or round table.

The second index is by product number. It lists, in alphanumeric order, the base product number, typically a five-digit number.

General Information

This book is effective April 2, 2018, subject to change without notice. Products may be purchased from authorized Herman Miller dealers who will quote prices upon request. For more information about our products and services or to see a list of dealers, visit www.HermanMiller.com.

All prices are list prices. Additional services, such as planning services, design, storage, and installation, are not included and must be added to these prices when the additional services are requested.

Illustrations, specifications, and prices are based on the latest information at the time of publication. The right is reserved to make changes at any time without notice in prices, fabrics, finishes, materials, specifications, and models, and also to discontinue models and finishes.

Dimensions shown in the drawings are engineering drawing dimensions rounded up to the nearest $\frac{1}{8}$ ". Product is shipped set up or knocked down. Products that include "Shipped knocked down" in the description require some assembly. If this statement does not appear in the description, the product is shipped assembled.

Service problems are normally handled by a Herman Miller authorized dealer. Where this cannot be accomplished on a local level, service problems should be referred to the Customer Care Representative for your region, Herman Miller, Inc., Zeeland, Michigan 49464.

20-Day or Less/Assigned Lead-Time Shipments

All products and options in this price book not designated by an Assigned Program icon  will ship in **20 business days or less** after being acknowledged by Herman Miller.

Products and options designated by an  are on the assigned lead-time program and may ship in 20 days, less than 20 days, or more than 20 days from order acknowledgement.

Vertical Files

Accessories



Standard-Pull Vertical File

36-15
36-18

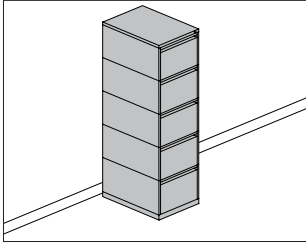

Product Information

Description

This 15"- or 18"-wide stacking vertical file has standard pulls and smooth or textured steel. The file has no top or a metal or laminate top. Each module can be specified as 1 file drawer or 2 box drawers. File drawers include a file compressor; box drawers include an adjustable drawer divider. A positive interlock system permits only 1 drawer to open at a time. 1 lock controls all drawers. 5 base heights are available; all bases include adjustable glides.

Actual vertical file depths are 17⁷/₈", 21⁷/₈", or 27⁷/₈".

Notes

1 counterweight is included for 18"-deep vertical files. For additional stability on 22"- and 28"-deep files, specify counterweight (CB).

Dimensional illustrations do not include all possible configurations.

18"-deep file drawers have 14" of filing capacity. 22"-deep file drawers have 18" of filing capacity. 28"-deep file drawers have 24" of filing capacity.

Order optional accessories for 15"-wide file separately:

- Drawer divider (73-1567-D)
- File drawer organizer (73-9874-FDO)
- Pencil tray (73-1516-PT)
- Stationery tray (73-7082-SST)

Order optional accessories for 18"-wide file separately:

- Drawer divider (73-1867-D)
- Pencil tray (73-1816-PT)
- Stationery tray (73-7082-SST-SP)

No lock option (NL) can only be specified on files with no top option (NT) or laminate top option (TL).

For keyed-alike locks, order lock plugs separately. See Keyed-Alike Information in Appendices.

Dimensions

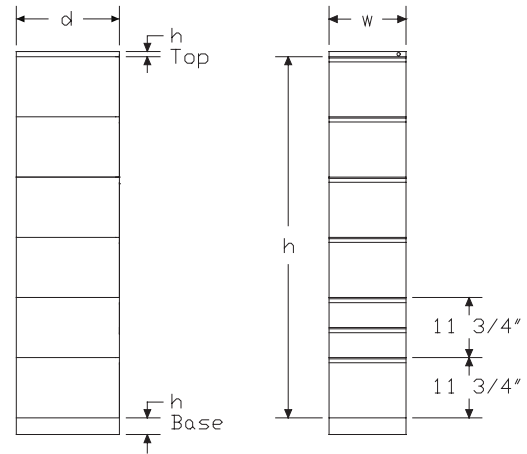

h	
2	23 1/2
3	35 1/4
4	47
5	58 3/4
6	70 1/2

All dimensions are in inches.

Specification Information		
Step 1.		
36-	A	
Step 2. Width		
15	15" wide	A
18	18" wide	A
Step 3. Depth		
18-	18" deep	A
22-	22" deep	A
28-	28" deep	A
Step 4. Number of Modules		
2	2 modules	A
3	3 modules	A
4	4 modules	A
5	5 modules	A
6	6 modules	A
Step 5. Paint/Steel Type		
SS	smooth paint on smooth steel	A +\$0
TS	smooth paint on textured steel	A +\$20
XS	textured paint on smooth steel	A +\$0
Step 6. Surface Finish		
Nonmetallic Paint		
<i>For smooth paint on smooth steel (SS) or smooth paint on textured steel (TS)</i>		
8Q	folkstone grey	A +\$0
91	white	A +\$0
98	studio white	A +\$0
9J	sparrow	A +\$0
BU	black umber	A +\$0
CL	cool grey neutral	A +\$0
G2	graphite satin	A +\$0
HF	inner tone light	A +\$0
HT	inner tone	A +\$0
LT	light tone	A +\$0
LU	soft white	A +\$0
MT	medium tone	A +\$0
SG	slate grey	A +\$0
WA	wheat	A +\$0
WL	sandstone	A +\$0

Metallic Paint		
<i>For smooth paint on smooth steel (SS) or smooth paint on textured steel (TS)</i>		
1209	platinum	A +\$65
1210	hematite	A +\$65
1212	bronzite	A +\$65
CN	metallic champagne	A +\$65
EH	metallic bronze	A +\$65
MS	metallic silver	A +\$65

Sand Texture Paint		
<i>For textured paint on smooth steel (XS)</i>		
98	studio white	A +\$0

Bright Sand Texture Paint		
<i>For textured paint on smooth steel (XS)</i>		
91	white	A +\$0
CL	cool grey neutral	A +\$0
G1	graphite	A +\$0
WN	warm grey neutral	A +\$0

Step 7. Top				
		18-	22-	28-
NT	no top	A +\$0	0	0
T1	1"-high painted metal top with squared edge	A +\$51	58	70
T2	1 1/4"-high painted metal top with squared edge	A +\$51	58	70
T3	1 1/4"-high painted metal top with radius edge	A +\$121	128	139
TL	1 1/4"-high laminate top with thermoplastic edge	A +\$133	141	149
TR	1 1/4"-high recut veneer top	A +\$219	225	236
TF	1 1/4"-high wood veneer top	A +\$224	232	242

Step 8.

Top Finish: Solid-Color Laminate

For 1 1/4"-high laminate top with thermoplastic edge (TL)

8Q	folkstone grey <input type="checkbox"/>	+\$0
91	white <input type="checkbox"/>	+\$0
98	studio white	+\$0
CL	cool grey neutral <input type="checkbox"/>	+\$0
HF	inner tone light <input type="checkbox"/>	+\$0
HT	inner tone <input type="checkbox"/>	+\$0
LT	light tone <input type="checkbox"/>	+\$0
LU	soft white <input type="checkbox"/>	+\$0
WL	sandstone <input type="checkbox"/>	+\$0
WN	warm grey neutral <input type="checkbox"/>	+\$0

Top Finish: Linen Laminate

For 1 1/4"-high laminate top with thermoplastic edge (TL)

LBM	crisp linen	+\$0
LBN	classic linen	+\$0
LBP	casual linen	+\$0

Top Finish: Mesh Laminate

For 1 1/4"-high laminate top with thermoplastic edge (TL)

LBK	pewter mesh	+\$0
LBL	steel mesh	+\$0

Top Finish: Twill Laminate

For 1 1/4"-high laminate top with thermoplastic edge (TL)

LBF	neutral twill	+\$0
LBG	sarum twill	+\$0
LBH	earthen twill	+\$0
LBJ	graphite twill	+\$0
LBQ	white twill	+\$0

Top Finish: Wood-Grain Laminate

For 1 1/4"-high laminate top with thermoplastic edge (TL)

HM	natural maple <input type="checkbox"/>	+\$0
HP	light anigre <input type="checkbox"/>	+\$0
LA	light ash <input type="checkbox"/>	+\$0
LBA	clear on ash	+\$0
LBB	oak on ash	+\$0
LBC	walnut on ash	+\$0
LBD	dark brown walnut	+\$0
LBU	medium matte walnut	+\$0
LBE	medium red walnut	+\$0
LM	mahogany <input type="checkbox"/>	+\$0
76	light brown walnut <input type="checkbox"/>	+\$0
HX	aged cherry <input type="checkbox"/>	+\$0
HY	walnut on cherry <input type="checkbox"/>	+\$0

Top Finish: Zephyr Laminate

For 1 1/4"-high laminate top with thermoplastic edge (TL)

28	canyon <input type="checkbox"/>	+\$0
29	misted <input type="checkbox"/>	+\$0

Veneer Top Finish: Wood Veneer

For 1 1/4"-high wood veneer top (TF)

2U	light brown walnut <input type="checkbox"/>	+\$20
40	dark brown walnut <input type="checkbox"/>	+\$20
ED	aged cherry <input type="checkbox"/>	+\$20
EK	medium red walnut <input type="checkbox"/>	+\$20
ET	clear on ash <input type="checkbox"/>	+\$20
EU	oak on ash <input type="checkbox"/>	+\$20
EV	walnut on ash <input type="checkbox"/>	+\$20
UL	natural maple <input type="checkbox"/>	+\$20
UX	walnut on cherry <input type="checkbox"/>	+\$20

Veneer Top Finish: Recut Veneer

For 1 1/4"-high recut veneer top (TR)

RA	light ash <input type="checkbox"/>	+\$0
RK	mahogany dark <input type="checkbox"/>	+\$0
RM	mahogany <input type="checkbox"/>	+\$0

Step 9. Edge Finish

For 1 1/4"-high laminate top with thermoplastic edge (TL)

98	studio white	+\$0
28	canyon <input type="checkbox"/>	+\$0
29	misted <input type="checkbox"/>	+\$0
76	light brown walnut <input type="checkbox"/>	+\$0
8Q	folkstone grey <input type="checkbox"/>	+\$0
91	white <input type="checkbox"/>	+\$0

Standard-Pull Vertical File *continued*

Meridian® Vertical Files

BU	black umber A	+\$0
CL	cool grey neutral A	+\$0
G2	graphite satin A	+\$0
HF	inner tone light A	+\$0
HM	natural maple A	+\$0
HP	light anigre A	+\$0
HT	inner tone A	+\$0
HX	aged cherry A	+\$0
HY	walnut on cherry A	+\$0
LA	light ash A	+\$0
LBA	clear on ash	+\$0
LBB	oak on ash	+\$0
LBC	walnut on ash	+\$0
LBD	dark brown walnut	+\$0
LBU	medium matte walnut	+\$0
LBE	medium red walnut	+\$0
LBK	pewter mesh	+\$0
LBL	steel mesh	+\$0
LBM	crisp linen	+\$0
LBN	classic linen	+\$0
LBP	casual linen	+\$0
LBF	neutral twill	+\$0
LBG	sarum twill	+\$0
LBH	earthen twill	+\$0
LBJ	graphite twill	+\$0
LBQ	white twill	+\$0
LM	mahogany A	+\$0
LU	soft white A	+\$0
MT	medium tone A	+\$0
SG	slate grey A	+\$0
WA	wheat A	+\$0
WL	sandstone A	+\$0
WN	warm grey neutral A	+\$0

Step 10. Lock/Filler Top

For 1 1/4"-high laminate top with thermoplastic edge (TL)

		18-	22-	28-
NL	no lock A	+\$0	0	0
10	1" locking filler top A	+\$51	58	70

Step 11. Lock

For no top (NT)

NL	no lock A	+\$0
-----------	---	------

For 1"-high painted metal top with squared edge (T1), 1 1/4"-high painted metal top with squared edge (T2), 1 1/4"-high painted metal top with radius edge (T3), 1 1/4"-high recut veneer top (TR), or 1 1/4"-high wood veneer top (TF)

KA	keyed alike A	+\$43
KC	keyed differently, chrome A	+\$43
KD	keyed differently, black A	+\$43

For 1" locking filler top (10)

KA	keyed alike A	+\$43
KC	keyed differently, chrome A	+\$43
KD	keyed differently, black A	+\$43

Step 12. Configuration (Top Module)

		1518-	1522-	1528-	1818-	1822-
V	file A	+\$273	280	292	281	288
Q	box/box A	+\$396	401	415	401	410
1828-						
V	file A					+\$301
Q	box/box A					+\$428

Step 13. Configuration (2nd Module from Top)

		1518-	1522-	1528-	1818-	1822-
V	file A	+\$273	280	292	281	288
Q	box/box A	+\$396	401	415	401	410
1828-						
V	file A					+\$301
Q	box/box A					+\$428

Step 14. Configuration (3rd Module from Top)

For 3 modules (3), 4 modules (4), 5 modules (5) AND 6 modules (6)

		1518-	1522-	1528-	1818-	1822-
V	file A	+\$273	280	292	281	301
Q	box/box A	+\$396	401	415	401	428

For 18" wide (18) with 22" deep (22-) with 3 modules (3), or 4 modules (4), or 5 modules (5), or 6 modules (6)

V	file A	+\$288
----------	--	--------

Step 15. Configuration (4th Module from Top)

For 4 modules (4), 5 modules (5) AND 6 modules (6)

		1518-	1522-	1528-	1818-	1822-
V	file A	+\$273	280	292	281	288
Q	box/box A	+\$396	401	415	401	410

Standard-Pull Vertical File *continued*

		1828-
V	file <input type="checkbox"/> A	+\$301
Q	box/box <input type="checkbox"/> A	+\$428

Step 16. Configuration (5th Module from Top)

		1518-	1522-	1528-	1818-	1822-
V	file <input type="checkbox"/> A	+\$273	280	292	281	288
Q	box/box <input type="checkbox"/> A	+\$396	401	415	401	410
		1828-				
V	file <input type="checkbox"/> A	+\$301				
Q	box/box <input type="checkbox"/> A	+\$428				

Step 17. Configuration (6th Module from Top)

		1518-	1522-	1528-	1818-	1822-
V	file <input type="checkbox"/> A	+\$273	280	292	281	288
Q	box/box <input type="checkbox"/> A	+\$396	401	415	401	410
		1828-				
V	file <input type="checkbox"/> A	+\$301				
Q	box/box <input type="checkbox"/> A	+\$428				

Step 18. Base Height

		18-	22-	28-
B1	1"-high base <input type="checkbox"/> A	+\$76	87	94
B2	1½"-high base <input type="checkbox"/> A	+\$76	87	94
B3	2¼"-high base <input type="checkbox"/> A	+\$76	87	94
B4	3¼"-high base <input type="checkbox"/> A	+\$76	87	94
B5	4¼"-high base <input type="checkbox"/> A	+\$111	124	142
BA	1"-high recessed base <input type="checkbox"/> A	+\$111	124	142
BB	1½"-high recessed base <input type="checkbox"/> A	+\$111	124	142
BC	2¼"-high recessed base <input type="checkbox"/> A	+\$111	124	142
BD	3¼"-high recessed base <input type="checkbox"/> A	+\$111	124	142

Step 19. Counterweight

		18-
CB	counterweight <input type="checkbox"/> A	+\$118

		22-	28-
NO	no counterweight <input type="checkbox"/> A	+\$0	
CB	counterweight <input type="checkbox"/> A	+\$118	

Bevel-Pull Vertical File

34-15
34-18

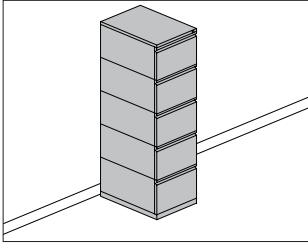

Meridian® Vertical Files

Product Information

Description

This 15"- or 18"-wide stacking vertical file has bevel pulls and smooth or textured steel. The file has no top or a metal or laminate top. Each module can be specified as 1 file drawer or 2 box drawers. File drawers include a file compressor; box drawers include an adjustable drawer divider. A positive interlock system permits only 1 drawer to open at a time. 1 lock controls all drawers. 5 base heights are available; all bases include adjustable glides.

Actual vertical file depths are 17⁷/₈", 21⁷/₈", or 27⁷/₈".

Notes

1 counterweight is included for 18"-deep vertical files. For additional stability on 22"- and 28"-deep files, specify counterweight (CB).

Dimensional illustrations do not include all possible configurations.

18"-deep file drawers have 14" of filing capacity. 22"-deep file drawers have 18" of filing capacity. 28"-deep file drawers have 24" of filing capacity.

Order optional accessories for 15"-wide file separately:

- Drawer divider (73-1567-D)
- File drawer organizer (73-9874-FDO)
- Pencil tray (73-1516-PT)
- Stationery tray (73-7082-SST)

Order optional accessories for 18"-wide file separately:

- Drawer divider (73-1867-D)
- Pencil tray (73-1816-PT)
- Stationery tray (73-7082-SST-SP)

No lock option (NL) can only be specified on files with no top option (NT) or laminate top option (TL).

For keyed-alike locks, order lock plugs separately. See Keyed-Alike Information in Appendices.

Dimensions

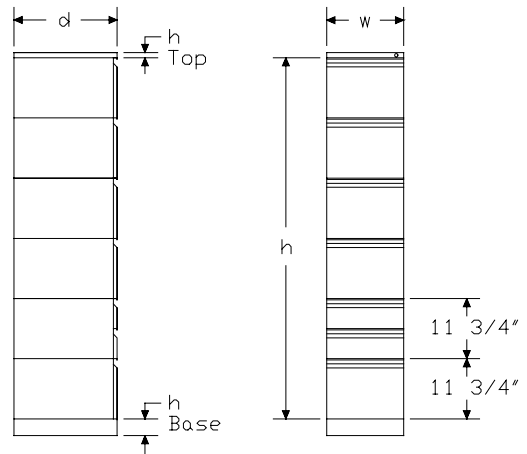

h	
2	23 1/2
3	35 1/4
4	47
5	58 3/4
6	70 1/2

All dimensions are in inches.

Specification Information

Step 1.

34- A

Step 2. Width

15 15" wide A

18 18" wide A

Step 3. Depth

18- 18" deep A

22- 22" deep A

28- 28" deep A

Step 4. Number of Modules

2 2 modules A

3 3 modules A

4 4 modules A

5 5 modules A

6 6 modules A

Step 5. Paint/Steel Type

SS smooth paint on smooth steel A +\$0

TS smooth paint on textured steel A +\$20

XS textured paint on smooth steel A +\$0

Step 6. Surface Finish

Nonmetallic Paint

For smooth paint on smooth steel (SS) or smooth paint on textured steel (TS)

8Q folkstone grey A +\$0

91 white A +\$0

98 studio white A +\$0

9J sparrow A +\$0

BU black umber A +\$0

G2 graphite satin A +\$0

HF inner tone light A +\$0

HT inner tone A +\$0

LM mahogany A +\$0

LT light tone A +\$0

LU soft white A +\$0

MT medium tone A +\$0

SG slate grey A +\$0

WA wheat A +\$0

WL sandstone A +\$0

Metallic Paint

For smooth paint on smooth steel (SS) or smooth paint on textured steel (TS)

1209 platinum A +\$65

1210 hematite A +\$65

1212 bronzite A +\$65

CN metallic champagne A +\$65

EH metallic bronze A +\$65

MS metallic silver A +\$65

Sand Texture Paint

For textured paint on smooth steel (XS)

98 studio white A +\$0

Bright Sand Texture Paint

For textured paint on smooth steel (XS)

91 white A +\$0

CL cool grey neutral A +\$0

G1 graphite A +\$0

WN warm grey neutral A +\$0

Step 7. Top

		18-	22-	28-
NT	no top <input type="checkbox"/> A	+\$0	0	0
T1	1"-high painted metal top with squared edge <input type="checkbox"/> A	+\$51	58	70
T2	1¼"-high painted metal top with squared edge <input type="checkbox"/> A	+\$51	58	70
T3	1¼"-high painted metal top with radius edge <input type="checkbox"/> A	+\$121	128	139
TL	1¼"-high laminate top with thermoplastic edge <input type="checkbox"/> A	+\$133	141	149
TR	1¼"-high recut veneer top <input type="checkbox"/> A	+\$219	225	236
TF	1¼"-high wood veneer top <input type="checkbox"/> A	+\$224	232	242

Step 8.

Top Finish: Solid-Color Laminate

For 1 1/4"-high laminate top with thermoplastic edge (TL)

8Q	folkstone grey <input type="checkbox"/>	+\$0
91	white <input type="checkbox"/>	+\$0
98	studio white	+\$0
BU	black umber <input type="checkbox"/>	+\$0
CL	cool grey neutral <input type="checkbox"/>	+\$0
HF	inner tone light <input type="checkbox"/>	+\$0
HT	inner tone <input type="checkbox"/>	+\$0
LT	light tone <input type="checkbox"/>	+\$0
LU	soft white <input type="checkbox"/>	+\$0
WL	sandstone <input type="checkbox"/>	+\$0
WN	warm grey neutral <input type="checkbox"/>	+\$0

Top Finish: Linen Laminate

For 1 1/4"-high laminate top with thermoplastic edge (TL)

LBM	crisp linen	+\$0
LBN	classic linen	+\$0
LBP	casual linen	+\$0

Top Finish: Mesh Laminate

For 1 1/4"-high laminate top with thermoplastic edge (TL)

LBK	pewter mesh	+\$0
LBL	steel mesh	+\$0

Top Finish: Twill Laminate

For 1 1/4"-high laminate top with thermoplastic edge (TL)

LBF	neutral twill	+\$0
LBG	sarum twill	+\$0
LBH	earthen twill	+\$0
LBJ	graphite twill	+\$0
LBQ	white twill	+\$0

Top Finish: Wood-Grain Laminate

For 1 1/4"-high laminate top with thermoplastic edge (TL)

HM	natural maple <input type="checkbox"/>	+\$0
HP	light anigre <input type="checkbox"/>	+\$0
LA	light ash <input type="checkbox"/>	+\$0
LBA	clear on ash	+\$0
LBB	oak on ash	+\$0
LBC	walnut on ash	+\$0
LBD	dark brown walnut	+\$0
LBU	medium matte walnut	+\$0
LBE	medium red walnut	+\$0
LM	mahogany <input type="checkbox"/>	+\$0
76	light brown walnut <input type="checkbox"/>	+\$0
HX	aged cherry <input type="checkbox"/>	+\$0
HY	walnut on cherry <input type="checkbox"/>	+\$0

Top Finish: Zephyr Laminate

For 1 1/4"-high laminate top with thermoplastic edge (TL)

28	canyon <input type="checkbox"/>	+\$0
29	misted <input type="checkbox"/>	+\$0

Veneer Top Finish: Wood Veneer

For 1 1/4"-high wood veneer top (TF)

2U	light brown walnut <input type="checkbox"/>	+\$20
40	dark brown walnut <input type="checkbox"/>	+\$20
ED	aged cherry <input type="checkbox"/>	+\$20
EK	medium red walnut <input type="checkbox"/>	+\$20
ET	clear on ash <input type="checkbox"/>	+\$20
EU	oak on ash <input type="checkbox"/>	+\$20
EV	walnut on ash <input type="checkbox"/>	+\$20
UL	natural maple <input type="checkbox"/>	+\$20
UX	walnut on cherry <input type="checkbox"/>	+\$20

Veneer Top Finish: Recut Veneer

For 1 1/4"-high recut veneer top (TR)

RA	light ash <input type="checkbox"/>	+\$0
RK	mahogany dark <input type="checkbox"/>	+\$0
RM	mahogany <input type="checkbox"/>	+\$0

Step 9. Edge Finish

For 1 1/4"-high laminate top with thermoplastic edge (TL)

98	studio white	+\$0
28	canyon <input type="checkbox"/>	+\$0
29	misted <input type="checkbox"/>	+\$0
76	light brown walnut <input type="checkbox"/>	+\$0
8Q	folkstone grey <input type="checkbox"/>	+\$0
91	white <input type="checkbox"/>	+\$0

BU	black umber <input type="checkbox"/>	+\$0
CL	cool grey neutral <input type="checkbox"/>	+\$0
G2	graphite satin <input type="checkbox"/>	+\$0
HF	inner tone light <input type="checkbox"/>	+\$0
HM	natural maple <input type="checkbox"/>	+\$0
HP	light anigre <input type="checkbox"/>	+\$0
HT	inner tone <input type="checkbox"/>	+\$0
HX	aged cherry <input type="checkbox"/>	+\$0
HY	walnut on cherry <input type="checkbox"/>	+\$0
LA	light ash <input type="checkbox"/>	+\$0
LBA	clear on ash	+\$0
LBB	oak on ash	+\$0
LBC	walnut on ash	+\$0
LBD	dark brown walnut	+\$0
LBU	medium matte walnut	+\$0
LBE	medium red walnut	+\$0
LBK	pewter mesh	+\$0
LBL	steel mesh	+\$0
LBM	crisp linen	+\$0
LBN	classic linen	+\$0
LBP	casual linen	+\$0
LBF	neutral twill	+\$0
LBG	sarum twill	+\$0
LBH	earthen twill	+\$0
LBJ	graphite twill	+\$0
LBQ	white twill	+\$0
LM	mahogany <input type="checkbox"/>	+\$0
LU	soft white <input type="checkbox"/>	+\$0
MT	medium tone <input type="checkbox"/>	+\$0
SG	slate grey <input type="checkbox"/>	+\$0
WA	wheat <input type="checkbox"/>	+\$0
WL	sandstone <input type="checkbox"/>	+\$0
WN	warm grey neutral <input type="checkbox"/>	+\$0

Step 10. Lock/Filler Top

For 1 1/4"-high laminate top with thermoplastic edge (TL)

		18-	22-	28-
NL	no lock <input type="checkbox"/>	+\$0	0	0
10	1" locking filler top <input type="checkbox"/>	+\$51	58	70

Step 11. Lock

For no top (NT)

NL	no lock <input type="checkbox"/>	+\$0
-----------	----------------------------------	------

For 1"-high painted metal top with squared edge (T1), 1 1/4"-high painted metal top with squared edge (T2), 1 1/4"-high painted metal top with radius edge (T3), 1 1/4"-high recut veneer top (TR), or 1 1/4"-high wood veneer top (TF)

KA	keyed alike <input type="checkbox"/>	+\$43
KC	keyed differently, chrome <input type="checkbox"/>	+\$43
KD	keyed differently, black <input type="checkbox"/>	+\$43

For 1" locking filler top (10)

KA	keyed alike <input type="checkbox"/>	+\$43
KC	keyed differently, chrome <input type="checkbox"/>	+\$43
KD	keyed differently, black <input type="checkbox"/>	+\$43

Step 12. Configuration (Top Module)

		1518-	1522-	1528-	1818-	1822-
V	file <input type="checkbox"/>	+\$273	280	292	281	288
Q	box/box <input type="checkbox"/>	+\$396	401	415	401	410
1828-						
V	file <input type="checkbox"/>					+\$301
Q	box/box <input type="checkbox"/>					+\$428

Step 13. Configuration (2nd Module from Top)

		1518-	1522-	1528-	1818-	1822-
V	file <input type="checkbox"/>	+\$273	280	292	281	288
Q	box/box <input type="checkbox"/>	+\$396	401	415	401	410
1828-						
V	file <input type="checkbox"/>					+\$301
Q	box/box <input type="checkbox"/>					+\$428

Step 14. Configuration (3rd Module from Top)

For 3 modules (3), 4 modules (4), 5 modules (5) AND 6 modules (6)

		1518-	1522-	1528-	1818-	1822-
V	file <input type="checkbox"/>	+\$273	280	292	281	288
Q	box/box <input type="checkbox"/>	+\$396	401	415	401	410
1828-						
V	file <input type="checkbox"/>					+\$301
Q	box/box <input type="checkbox"/>					+\$428

Step 15. Configuration (4th Module from Top)

For 4 modules (4), 5 modules (5) AND 6 modules (6)

		1518-	1522-	1528-	1818-	1822-
V	file <input type="checkbox"/>	+\$273	280	292	281	288
Q	box/box <input type="checkbox"/>	+\$396	401	415	401	410

Bevel-Pull Vertical File *continued*

		1828-
V	file <input type="checkbox"/> A	+\$301
Q	box/box <input type="checkbox"/> A	+\$428

Step 16. Configuration (5th Module from Top)

		1518-	1522-	1528-	1818-	1822-
V	file <input type="checkbox"/> A	+\$273	280	292	281	288
Q	box/box <input type="checkbox"/> A	+\$396	401	415	401	410
		1828-				
V	file <input type="checkbox"/> A	+\$301				
Q	box/box <input type="checkbox"/> A	+\$428				

Step 17. Configuration (6th Module from Top)

		1518-	1522-	1528-	1818-	1822-
V	file <input type="checkbox"/> A	+\$273	280	292	281	288
Q	box/box <input type="checkbox"/> A	+\$396	401	415	401	410
		1828-				
V	file <input type="checkbox"/> A	+\$301				
Q	box/box <input type="checkbox"/> A	+\$428				

Step 18. Base Height

		18-	22-	28-
B1	1"-high base <input type="checkbox"/> A	+\$76	87	94
B2	1½"-high base <input type="checkbox"/> A	+\$76	87	94
B3	2¼"-high base <input type="checkbox"/> A	+\$76	87	94
B4	3¼"-high base <input type="checkbox"/> A	+\$76	87	94
B5	4¼"-high base <input type="checkbox"/> A	+\$111	124	142
BA	1"-high recessed base <input type="checkbox"/> A	+\$111	124	142
BB	1½"-high recessed base <input type="checkbox"/> A	+\$111	124	142
BC	2¼"-high recessed base <input type="checkbox"/> A	+\$111	124	142
BD	3¼"-high recessed base <input type="checkbox"/> A	+\$111	124	142

Step 19. Counterweight

		1828-
CB	counterweight <input type="checkbox"/> A	+\$118

		1828-
NO	no counterweight <input type="checkbox"/> A	+\$0
CB	counterweight <input type="checkbox"/> A	+\$118

Pencil Tray for Box Drawer,
Meridian® Pedestal

73-15
73-18

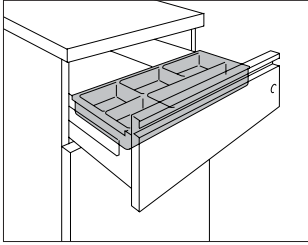

Product Information

Description

This plastic drawer stores pencils and other small items in a box drawer. The 12"-wide pencil tray fits in a 15"-wide box drawer; the 15"-wide pencil tray fits in an 18"-wide box drawer. Finish is black umber.

Notes

Pencil tray cannot be used in Tu® pedestals or Quadrant® pedestals. For 5000 Series furniture, pencil tray can be used in standard-, bevel-, or contour-pull pedestals.

Dimensions

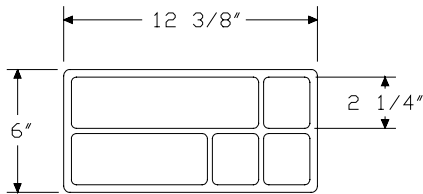
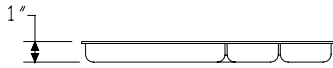

For 15" Wide Drawers

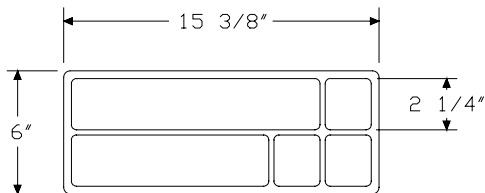

For 18" Wide Drawers

Specification Information

Step 1.

73-

Step 2. Width

1516-PT for 15"-wide drawer (for Meridian® pedestals and 5000 Series furniture)

1816-PT for 18"-wide drawer (for Meridian® pedestals)

Prices for Steps 1-2.

73-1516-PT	\$21
73-1816-PT	\$24

Drawer Divider for Box Drawer, Meridian® Pedestal 73-15
73-18

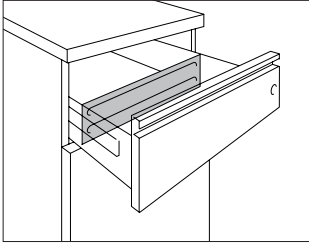

Meridian® Vertical File Accessories

Product Information

Description
This adjustable divider is used in a box drawer. The 12"-wide divider fits in a 15"-wide box drawer; the 15"-wide divider fits in an 18"-wide box drawer. Finish is black umber.

Notes
Drawer divider cannot be used in Tu® pedestals or Quadrant® pedestals. For 5000 Series furniture, drawer divider can be used in standard-, bevel-, or contour-pull pedestals.

Dimensions

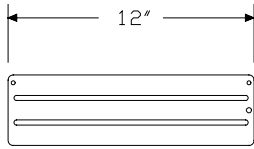
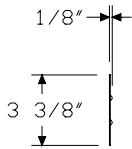

For 15" Wide Drawer

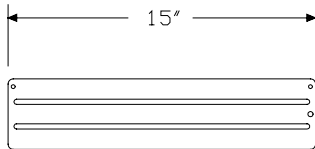

For 18" Wide Drawer

Specification Information

Step 1.
73-

Step 2. Width
1567-D for 15"-wide drawer (for Meridian® pedestals and 5000 Series furniture)
1867-D for 18"-wide drawer (for Meridian® pedestals)

Prices for Steps 1-2.

73-1567-D	\$15
73-1867-D	\$18

Stationery Tray for Box Drawer, Meridian® Pedestal 73-70

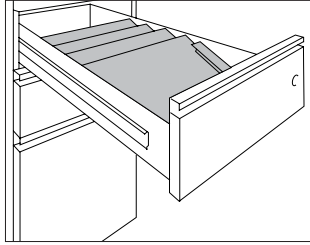

Product Information

Description

This sectioned tray stores envelopes, stationery, and forms in a box drawer. The 12"-wide tray fits in a 15"-wide box drawer; the 15"-wide tray fits in an 18"-wide box drawer. Finish is black umber.

Notes

Stationery tray cannot be used in Tu® pedestals or Quadrant® pedestals. For 5000 Series furniture, stationery tray can be used in standard-, bevel-, or contour-pull pedestals.

Dimensions

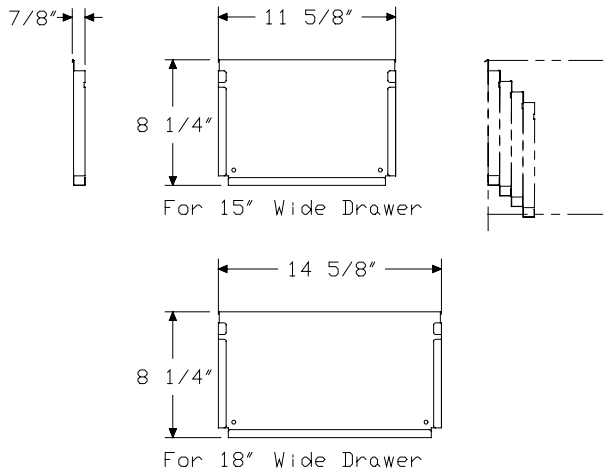

Specification Information

Step 1.

73-7082-

Step 2. Width

SST for 15"-wide drawer (for Meridian® pedestals and 5000 Series furniture)

SST-SP for 18"-wide drawer (for Meridian® pedestals)

Prices for Steps 1-2.

73-7082- SST	\$107
SST-SP	\$119

File Drawer Organizer, Meridian® 73-98
Pedestal

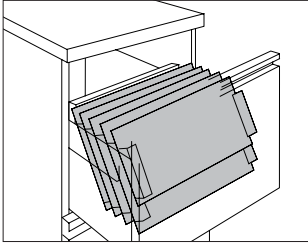

Meridian® Vertical File Accessories

Product Information

Description
This sectioned organizer stores letter-size stationery and papers in a file drawer. The 12"-wide organizer fits in a 15"-wide file drawer; the 15"-wide organizer fits in an 18"-wide file drawer. Finish is black umber.

Notes
File drawer organizer cannot be used in Tu® pedestals or Quadrant® pedestals.
For 5000 Series furniture, file drawer organizer can be used in standard-, bevel-, or contour-pull pedestals.

Dimensions

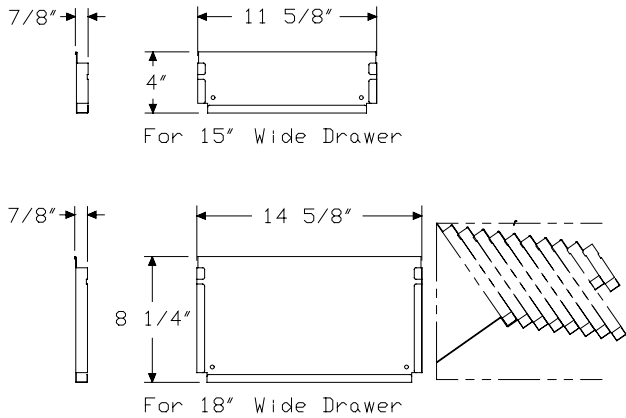

Specification Information

Step 1.
73-9874-

Step 2. Width
FDO for 15"-wide drawer (for Meridian® pedestals and 5000 Series furniture)
FDO-SP for 18"-wide drawer (for Meridian® pedestals)

Prices for Steps 1-2.

73-9874-	FDO	\$189
	FDO-SP	\$227

File Drawer Organizer

LG901

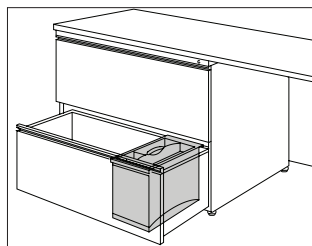

Product Information

Description

This 2-sectioned organizer fits into any file drawer arranged for letter-size filing. The removable top section stores computer disks and other small items. The bottom section stores larger items or can be divided into 3 compartments; it includes 2 vertical dividers. Finish is black umber.

Dimensions

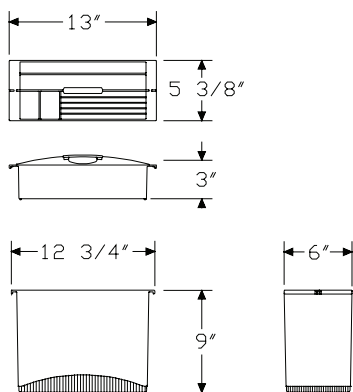

Specification Information

Step 1.

LG901

\$77

EnhancedAccess™ Pull

EAP-L

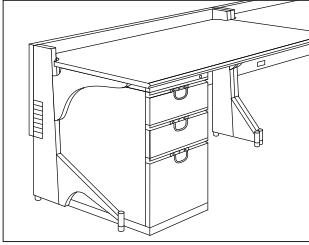

Product Information

Description

This plastic loop-style pull slides into the standard pull or Tu® W-pull on a pedestal or lateral file drawer. It makes the drawer easier to open. Package contains 1 pull and attachment hardware.

Dimensions

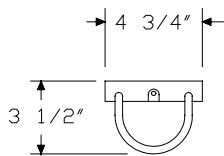

Specification Information

Step 1.

EAP-

Step 2. Pull Style

L loop

Prices for Steps 1-2.

EAP-L \$54

Step 3. Finish

BU	black umber	+\$0
HF	inner tone light	+\$0
MT	medium tone	+\$0

Index by Product Name

Meridian® Vertical Files	
Bevel-Pull Vertical File	page(s) 10
Drawer Divider for Box Drawer, Meridian® Pedestal	16
EnhancedAccess™ Pull	20
File Drawer Organizer	19
File Drawer Organizer, Meridian® Pedestal	18
Pencil Tray for Box Drawer, Meridian® Pedestal	15
Standard-Pull Vertical File	5
Stationery Tray for Box Drawer, Meridian® Pedestal	17



Index by Product Number



34-15	Bevel-Pull Vertical File	page(s) 10
34-18		
36-15	Standard-Pull Vertical File	5
36-18		
73-15	Drawer Divider for Box Drawer, Meridian® Pedestal	16
73-15	Pencil Tray for Box Drawer, Meridian® Pedestal	15
73-18	Drawer Divider for Box Drawer, Meridian® Pedestal	16
73-18	Pencil Tray for Box Drawer, Meridian® Pedestal	15
73-70	Stationery Tray for Box Drawer, Meridian® Pedestal	17
73-98	File Drawer Organizer, Meridian® Pedestal	18
EAP-L	EnhancedAccess™ Pull	20
LG901	File Drawer Organizer	19



20-Day or Less/Assigned Lead-Time Order Information

20-Day or Less and Assigned Lead-Time Programs

20-day or less and assigned lead-time products are designed for established Herman Miller dealers with pre-approved credit.

Products are distributed from multiple manufacturing facilities across the United States. All products and options not designated by an Assigned Lead-Time icon  will ship in 20 business days or less after being acknowledged by Herman Miller. Products and options designated by an  are on the assigned lead-time program and will ship in 20 days, less than 20 days, or more than 20 days from order acknowledgement.

Ordering Procedure

Please place orders through Order Manager. If this is not available to you, place orders through mail or fax. Verbal purchase orders will not be accepted.

Order Entry fax number for Passage®, 5000 Series, and Meridian® Filing and Storage: (616) 846 9236.

Order Entry fax number for all other products:
(616) 654 3085.

For more information, contact your Customer Care representative at:
(866) 854 3048 EXT 3400.

Shipments and Delivery

Per Herman Miller Terms and Conditions.

Changes and Cancellation

Per Herman Miller Terms and Conditions.



Keyed-Alike Information

Keyed-Alike Locks

All components with locks may be specified keyed alike. Products with keyed-alike locks will be shipped with lock chassis installed.

Installation of lock cylinders will be on-site according to instructions provided. Herman Miller, Inc., will not be responsible for lock cylinder installation.

When specifying product keyed-alike, include separate lines on your order for the lock cylinders.

For Action Office®, Ethospace®, Passage®, Quadrant®, Resolve®, and Supplemental products, list cylinder part number and key number (232092-XXX); select a key number (or numbers) between 226 and 427, excluding numbers 408 and 412.

The following products require a different lock cylinder part number. Specify UKY001-XXX for these products only; select a key number (or numbers) between 226 and 427, excluding numbers 408 and 412.

- A3013.
- A3053.
- G5180.
- G5181.
- G5280.

The keys provided in 232092-XXX and UKY001-XXX kits work with either cylinder type, provided the key numbers match.

For Tu® Storage, Canvas Office Landscape®, 5000 Series, and Meridian® Storage, see the following charts.

Keyed-alike locks are field installed.

To order keyed-alike locks for Action Office® Series 1 and 2 door panels, please contact Customer Care.

A master key can be used to open any lock on an attached or freestanding component. In addition, a removal key or lock change tool is required to remove lock plugs. Customers interested in ordering master keys, removal keys, or lock change tools should contact Customer Care.

For Canvas overhead and lower storage units, specify as follows:

Specification Code	Part Number	Color	Lock Series
KA	1B2JK7-XXX ¹	chrome	UM series 226-427

For Meridian Storage, Tu Storage, and 5000 Series desk components with pedestals, specify as follows:

Specification Code	Key Number	Color	Lock Series
KA	232092-XXX ¹	black	UM series 226-427
KA	1B2JK7-XXX ¹	chrome	UM series 226-427

For 5000 Series flipper door unit with bezel or credenza storage cabinet with bezel, specify as follows:

Specification Code	Key Number	Color	Lock Series
KA	232092-XXX ¹	black	UM series 226-427

Key Number:

XXX¹ = a key number between 226 and 427 (excluding 408 and 412)



Stain-to-Match Program

Stain-to-Match Program

Program Overview

The Stain-to-Match program gives you the option of using veneer finishes that are not listed in the standard offering. The program allows Herman Miller to match a customer's existing recut or natural veneer, or create a new finish that is unique to an installation.

Specific information on approval, ordering, pricing, and warranty for the Stain-to-Match program is listed below. Questions and requests for assistance may be directed to Herman Miller Options at:

(800) 654 3910

Ordering Products with Stain-to-Match Veneers

1. Fill out the Options Stain-to-Match Request Form and send along with a color sample (2" x 3" minimum) to the Herman Miller Options Applications Team at the address provided on the form. The form can be found on Omni.
2. Within 7-10 working days, Herman Miller Options will send a sample of the color-matched stain on Herman Miller veneer to the requester for the customer's signed approval.
3. If the sample meets the customer's approval, sign the reverse side of the sample, scan and email the approval to:
options@hermanmiller.com.
4. After the stain has been approved, a formal quotation with special number and pricing can be provided, or the product can be specified through the Vary Easy program, if available. Work with the Options team on final product needs and how to specify.
5. A purchase order can then be placed.

Stain-to-Match Warranty

Herman Miller warrants its products to be free from defects in craftsmanship from the date of delivery for the applicable warranty period. Herman Miller is responsible for the physical properties of the veneers available through the Stain-to-Match program, which include:

- STA: Stain-to-Match on Recut Ash
- STB: Stain-to-Match on Beech
- STC: Stain-to-Match on Cherry
- STD: Stain-to-Match on Oak
- STK: Stain-to-Match on Reltech Anigre (Geiger)
- STM: Stain-to-Match on Recut Mahogany
- STP: Stain-to-Match on Maple
- STU: Stain-to-Match on Walnut (Geiger)

See your specification tool for product specific finish offering limitations.

For more information about our products and services or to see a list of dealers, please visit us at HermanMiller.com or call (800) 851 1196.

© 2018 Herman Miller, Inc., Zeeland, Michigan

® **HermanMiller**, ●, Action Office, Aeron, Aside, Avive, Canvas Office Landscape, Caper, Celle, Co/Struc, Eames, Embody, Equa 2, Ergon 3, Ethospace, Exclave, Fine-Tune, FlexFront, Formcoat, Ground Cloth, Herman Miller Healthcare, Layout Studio, Maharam, Meridian, Mirra, Passage, Pellicle, Perspectives, PostureFit, Resolve, Sayl, Setu, Thrive, Tu, Y-Tower, and Z-Axis are among the registered trademarks of Herman Miller, Inc., and its owned subsidiaries.

™ AireWeave, Bubbletack, Cellular Suspension, Compass, Connect, DOT, Durawrap, Everywhere, Flex-Edge, Hopsak 2, Intent, Iota, Keyless Entry, Latitude, Lyris 2, Motia, Multiscrim, Nelson, Renew, Stackable, Swoop, TriFlex, Twist, and Verus are among the trademarks of Herman Miller, Inc., and its owned subsidiaries.

®Chemsurf® is a registered trademark of Wilsonart International.

Corian® is a registered trademark of E.I. du Pont de Nemours and Company Corporation.

FLEXNET™ is a trademark of Milliken & Company.

Floor Saver Glide® is a registered trademark of Carpin Manufacturing, Inc.

Geiger® is a registered trademark of Geiger International.

Microsoft® and Natural® Keyboard are registered trademarks of Microsoft Corporation.

Place Textiles® is a registered trademark of Place Textiles.