



Parts Included:



Arm Pad



Screw

Tools Required:

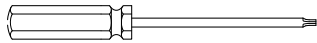

T25 Torx driver

Steps:

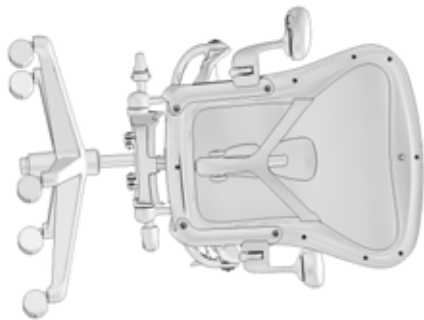

1. Lay chair on the side.

Fixed or Pivot only

Adjustable



2. If your chair has fixed or pivot only arms, proceed to step 3. If it is adjustable arm chair skip to step 6



3. Remove the screw to detach the arm pad. Use T25 Torx bit to remove the screw.

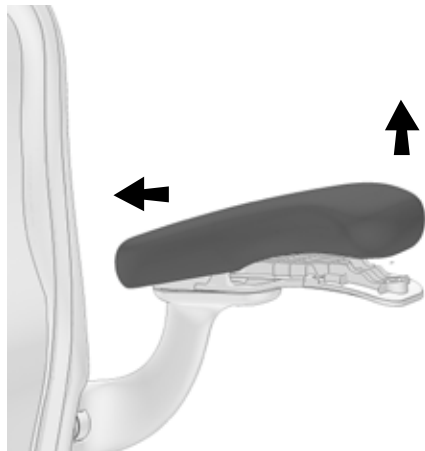

4. Lift the pad on the front and slide backwards as shown above to disengage it from the arm support.



5. Detach the arm pad.



6. Remove the screw to detach the arm pad for adjustable arm. Use T25 Torx bit to remove the screw.

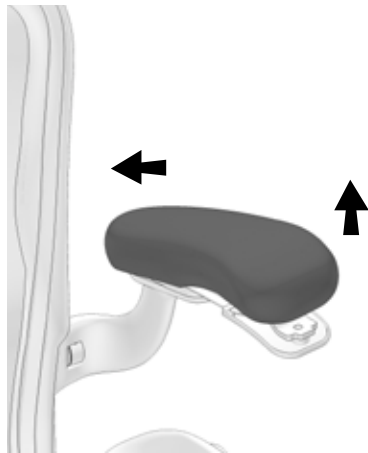
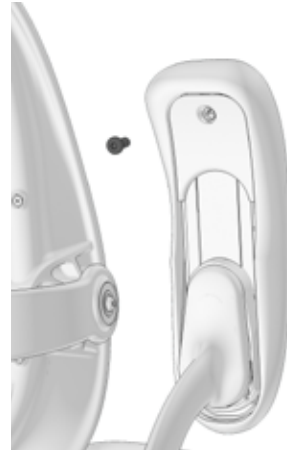

7. Lift the pad on the front and slide backwards as shown above to disengage it from the arm support.

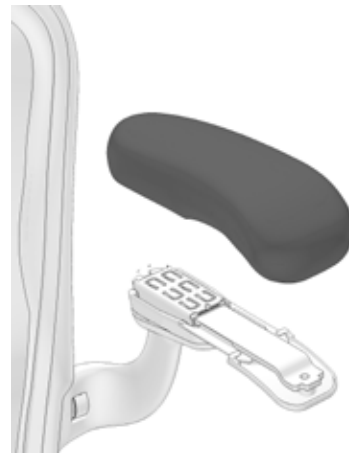

8. Detach the arm pad.



9. Note that the cover will get detached while removing the arm pad.

Re-Assembly Steps:



10. If your chair has fixed or pivot only arms, proceed to step 11. If it is adjustable arm chair skip to step 14.

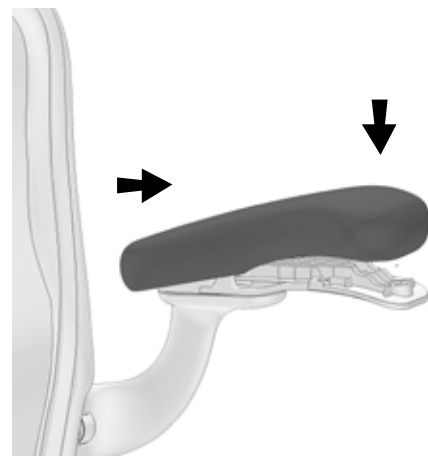

11. Slide the rear of the arm pad pocket over tab on arm support. Rotate front of arm pad down into position.



12. Place the arm pad in place on the arm casting and install the screw.



13. Use T25 torx bit to install the screw.

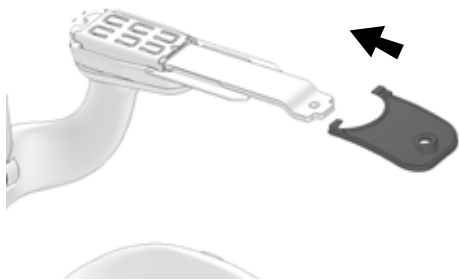

14. Reinstall the cover back in the position.



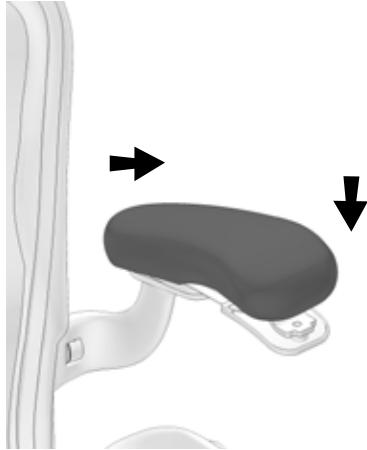

15. Slide the rear of the arm pad pocket over tab on arm support. Rotate front of arm down into position.



16. Reinstall the new arm pad to the arm support.



17. Use T25 torx bit to install the screw.