

HermanMiller

The Collection

Noguchi® Rudder Coffee Table (IN52)



How to assemble your table.

For more information about our products and services or to see a list of dealers, please visit us at hermanmiller.com or call (800) 851 1196.

© 2013 Herman Miller, Inc., Zeeland, Michigan Printed in U.S.A. Part No. 1BBF9Z - A.

© Noguchi are among the registered trademarks of Herman Miller, Inc.

Tools Required

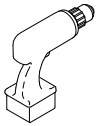

Power Driver



#2 Philips drive bit

Parts Included

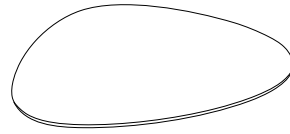

(1) Top

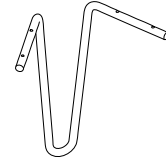

(2) Wire Leg (Qty: 2)

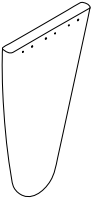

(3) Wood Leg (Qty: 1)



(4) Long Screw (Qty: 8)

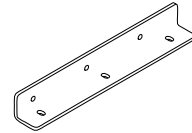

(5) Leg Brackets (Qty: 2)



(6) Short Screw (Qty: 12)

Step 1

- 1.1 By hand, place the Top upside down on a protective surface.
- 1.2 Position leg to the top in a way the screw holes on the leg are aligned to the screw holes on the top.
- 1.3 Using power driver on low torque setting, tighten screws.
- 1.4 Repeat for other leg.

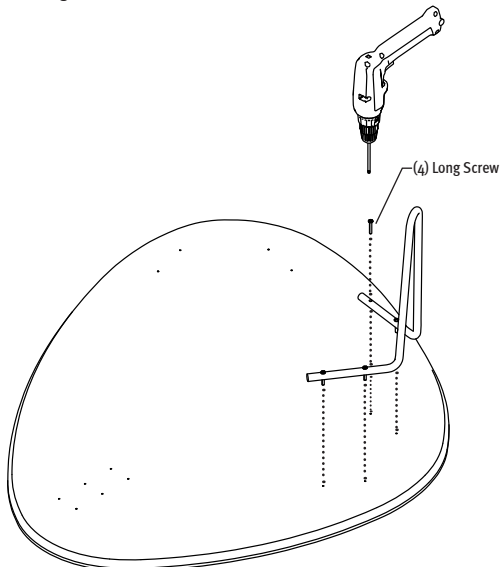

Step 2

- 2.1 Assemble Leg Brackets to Wood Leg.

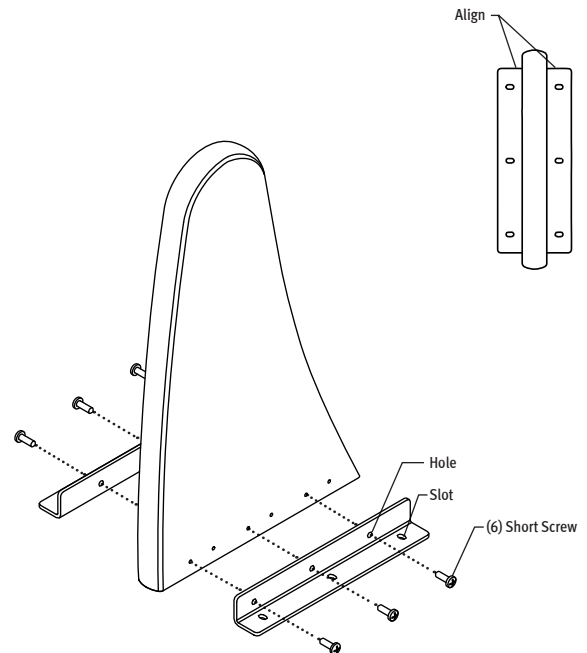

Step 3

3.1
Position Wooden leg to the top in a way the screw holes on the Wooden leg are aligned to the screw holes on the top.

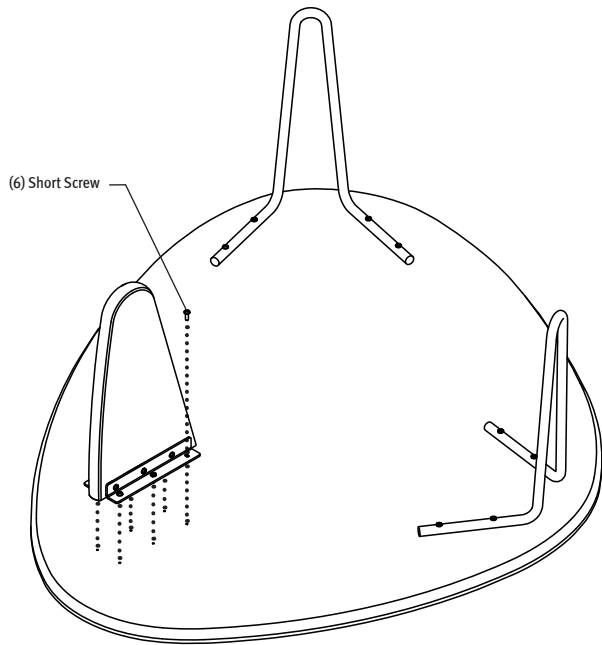

Step 4

4.1
Using power driver tighten the screws. See step 4-A.

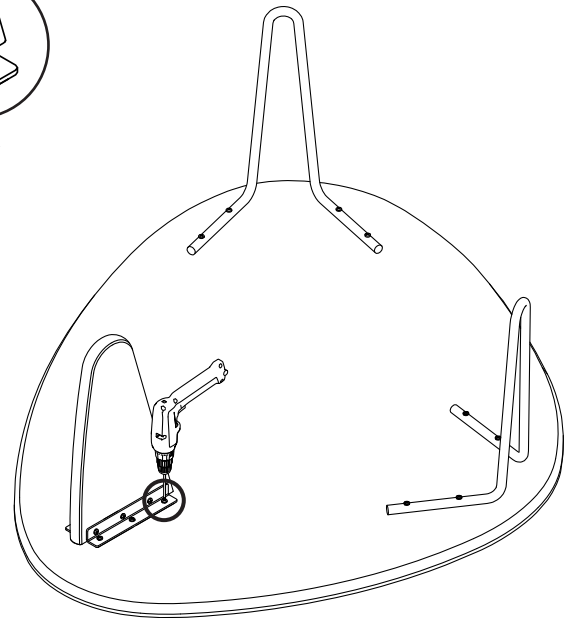
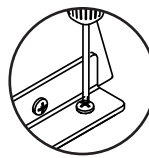

Step 5

5.1
Rotate the table back to its original position.

