

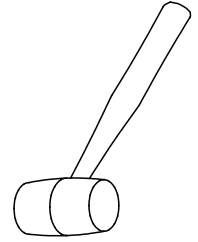
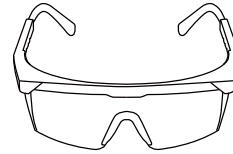
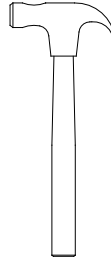
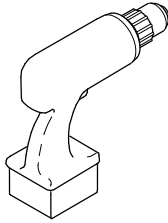

Table of Content

1. Work Chair Disassembly	2
2. Side Chair Disassembly	17
3. Work Stool Footring Disassembly	22



Tools Required:



Flat Screw Driver

Power driver

T-40 Torx Driver

Hammer

Nose Plier

Safety Glasses

Rubber Mallet

Materials Identification and Segregation:

Where possible, plastic components are marked with ASTM recycling codes. Use these codes to identify material type for recycling. Non marked components should be treated as mixed plastic. Ferrous metals can be identified using a small magnet for recycling. Non-ferrous metals should be separated and recycled separately.

Work Chair Disassembly

Steps:

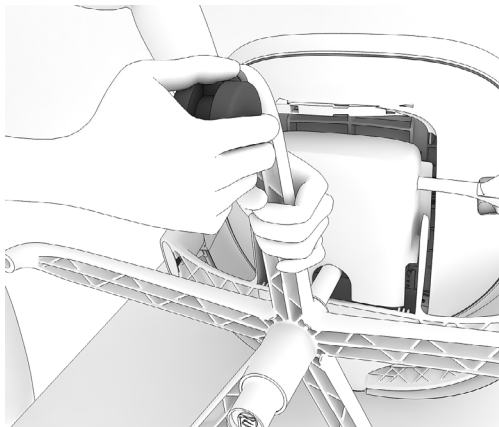

1. Hold base and pull hard to remove caster from base.

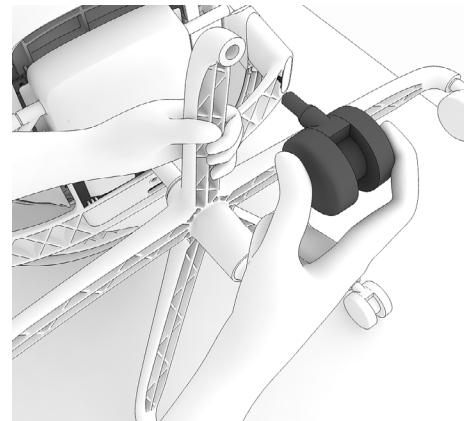

2. Remove all casters.

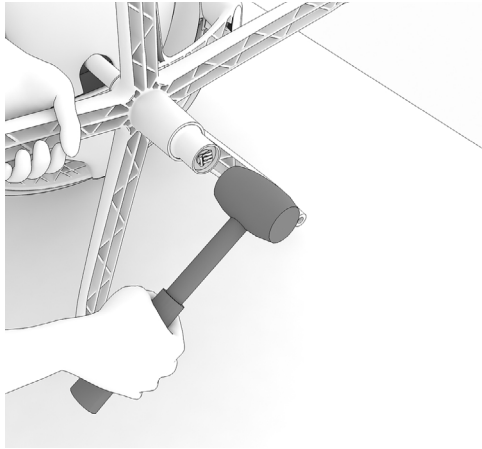

3. Hold base legs firmly and strike the bottom of cylinder with a rubber mallet until base comes loose.



4. Disengage the base from cylinder.

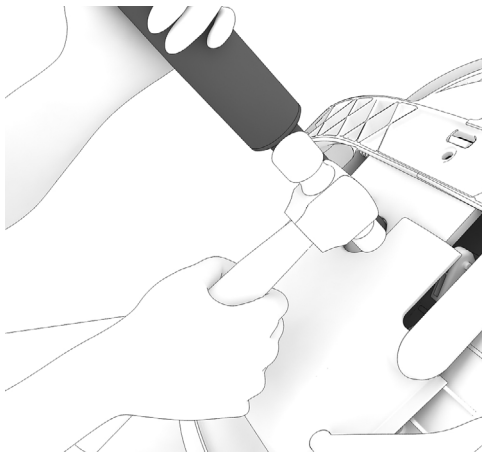

5. Place one hand on can of cylinder and hit with hammer.

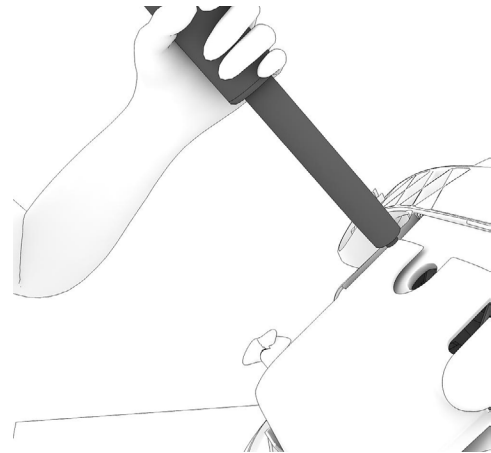

6. Remove cylinder.

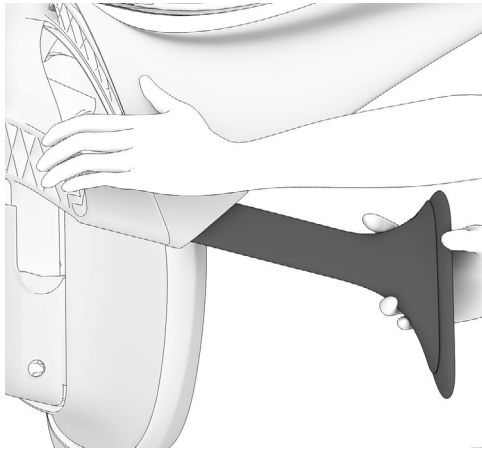

7. Pull arm to the highest position.

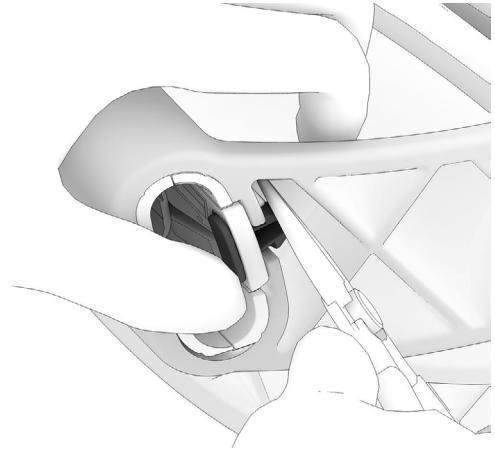

8. Using nose plier depress the retention clip.

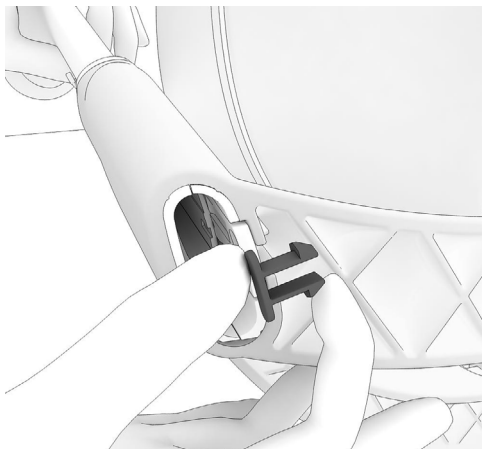

9. Pull off the retention clip.

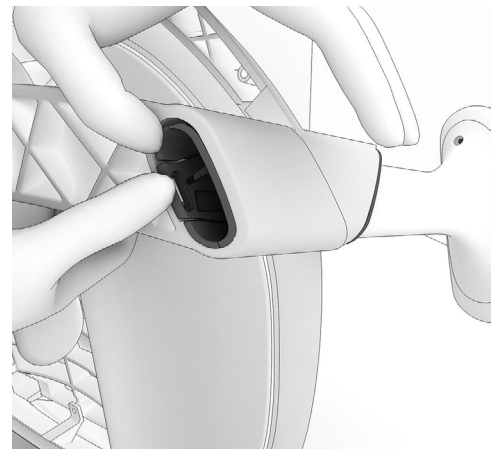

10. Depress the lock inward and pull the arm up to remove.

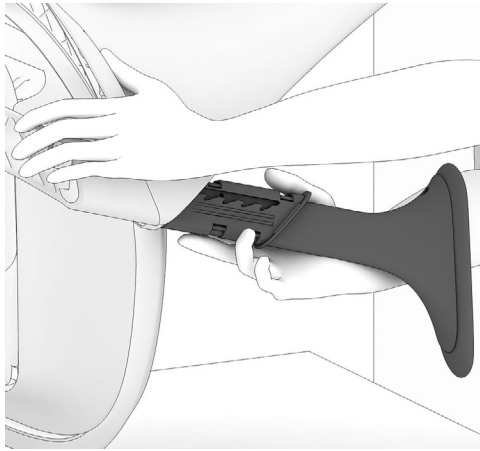

11. Repeat 7 to 10 steps to remove other side arm.

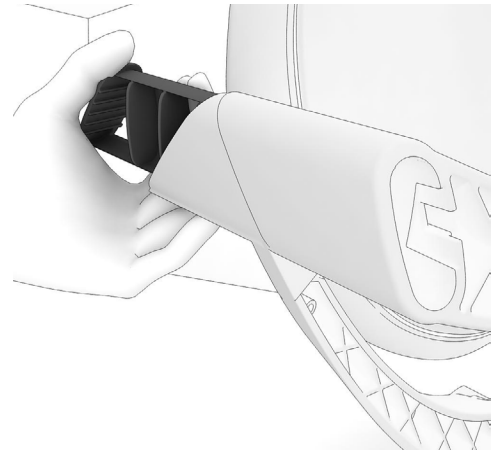

Note: If removing a no arm plug, depress the lock inward as in step 10 and remove arm plug.

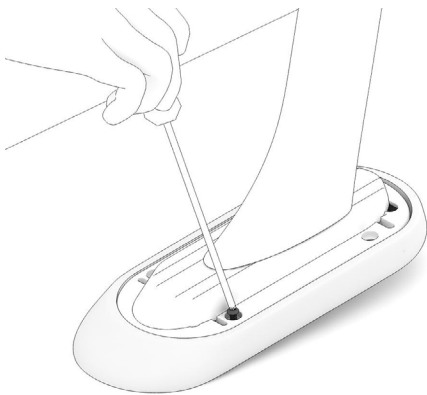

12. Using T-20 torx driver remove arm pad screws (4 screws for adjustable pad, 1 screw for fixed pad).



13. Slide pad forward and off.

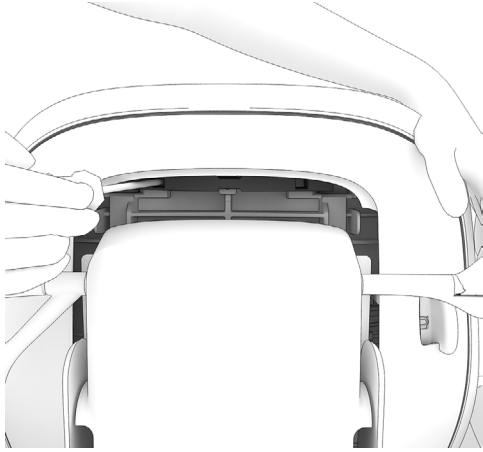

14. Lay chair on back. Using flat head screw driver pry away (both sides until seat lock bar comes out).



15. Remove lock bar.

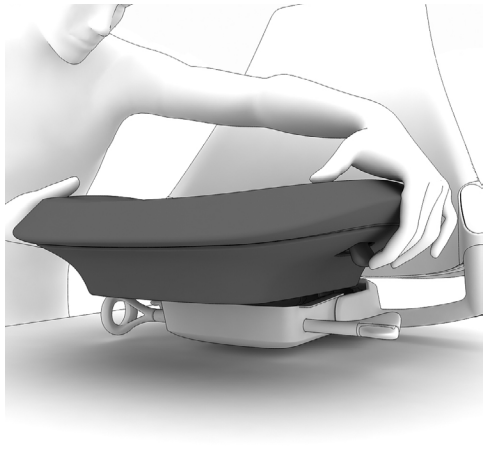

16. Release the seat lock move seat to the backward position.

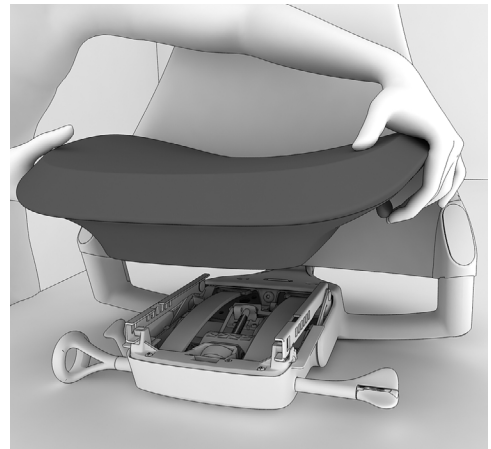

17. Lift upward to remove.

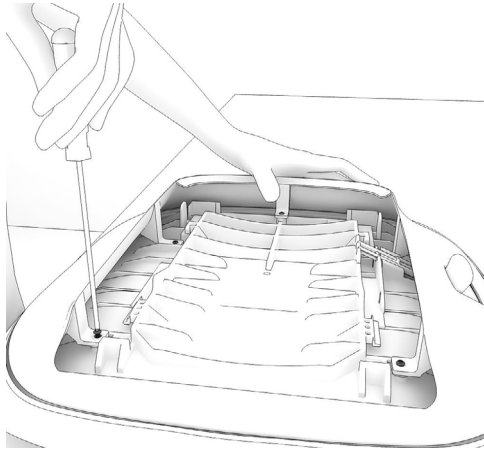

18. Remove all 4 T-20 torx screws.

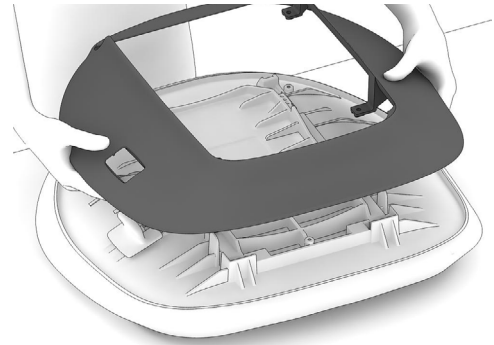

19. Remove seat skirt. Seat skirt is also held on by 4 clips. Carefully pull the seat skirt loose from these clips. With screw driver pry out and remove any clips that remain lodged in the seat frame.

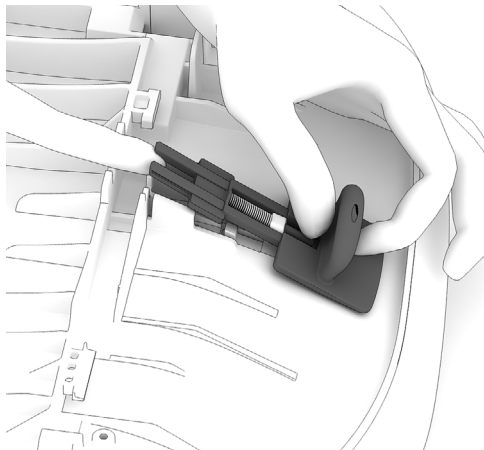

20. Slide latch to outside of seat frame until tabs are disengaged.

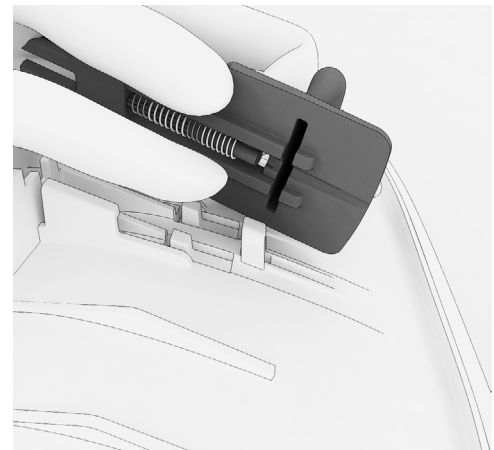

21. Unsnap the latch from seat frame and remove spring.



22. Remove the upholstery from seat.

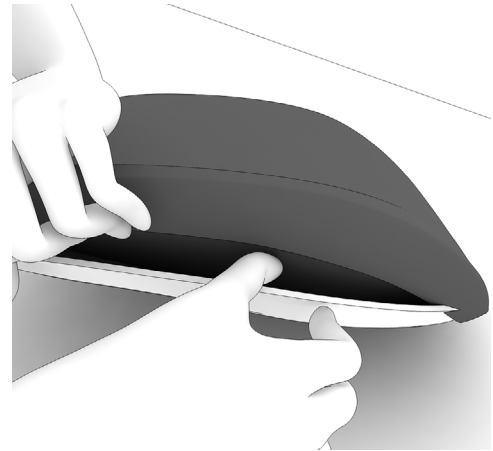

23. Remove the seat foam from the seat bottom.

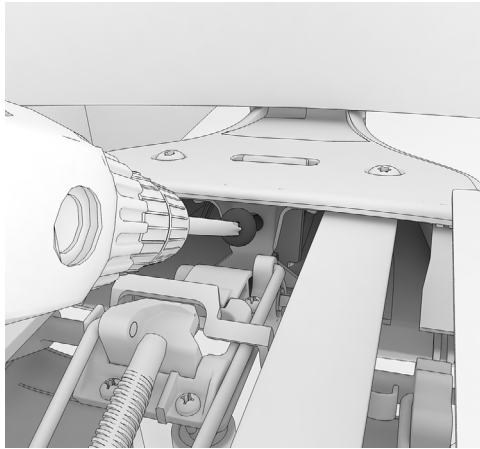

24. Using a power driver with T-40 torx remove top bolt.

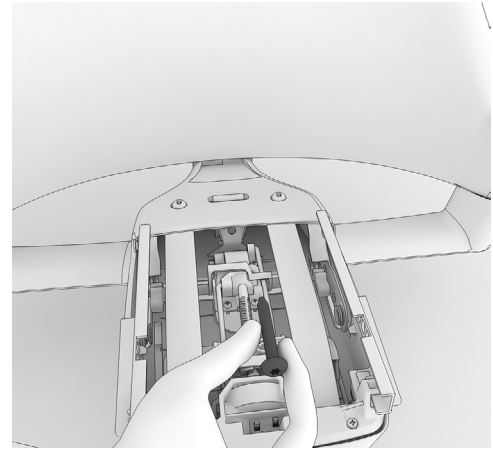

25. Remove the bolt from tilt assembly.

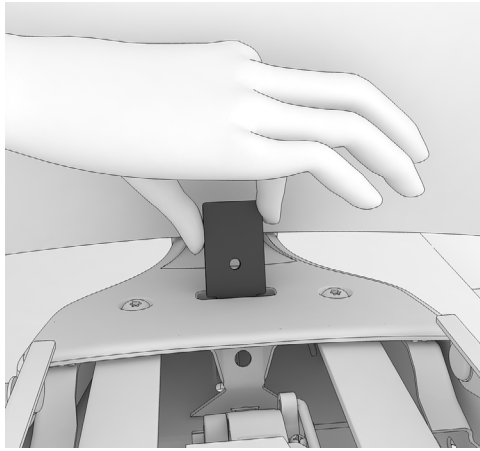

26. Remove the plate from the tilt assembly.

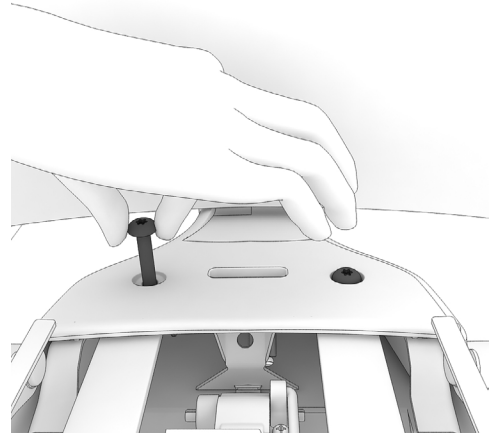

27. Using T-40 torx remove 2 screws from tilt assembly.

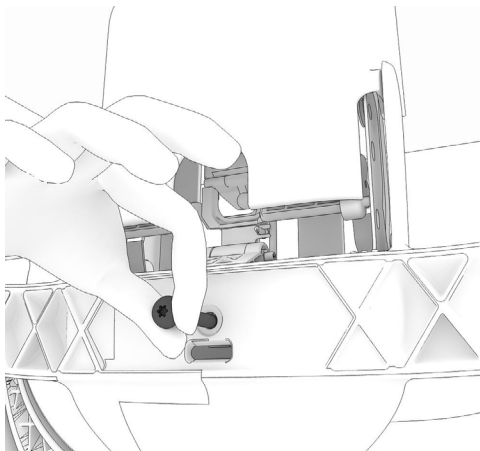

28. Remove bottom screw.

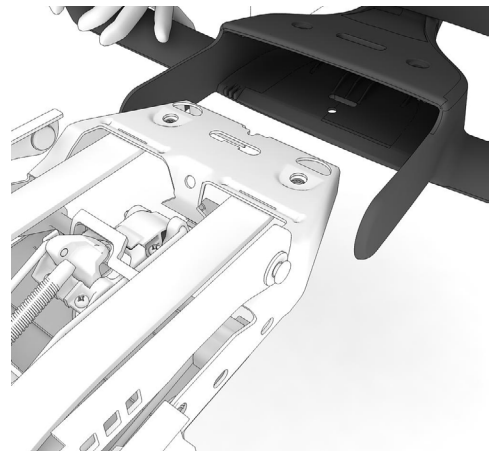

29. Slide off the back assembly.

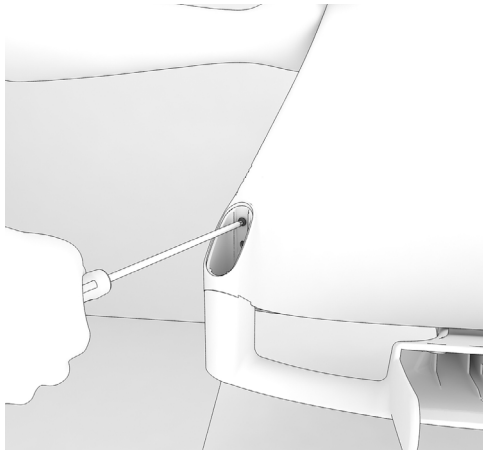

30. Remove top screws from each side using a T-25 torx from the frame.

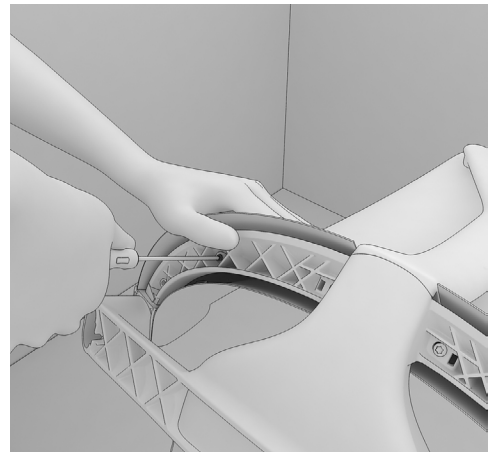

31. Turn it over and remove back attachment screws using a T-20 torx.

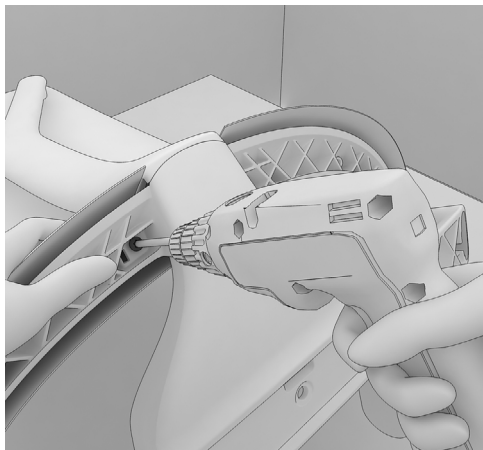

32. Remove back attachment screws using a T-40 torx.

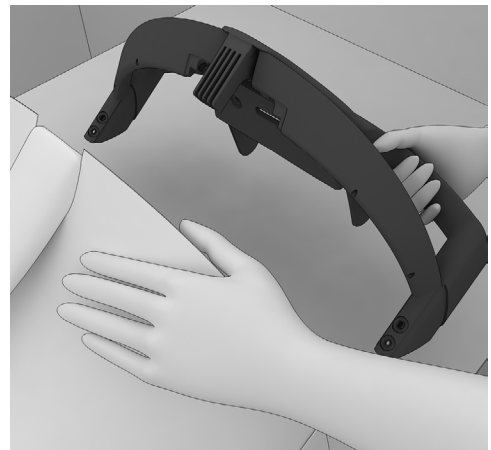

33. Remove pelvis.

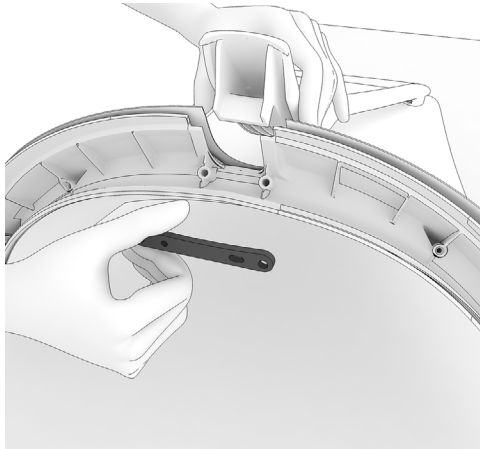

34. Using hand slightly pull back the spine from the back and remove the spine bracket plate from bottom of the back.

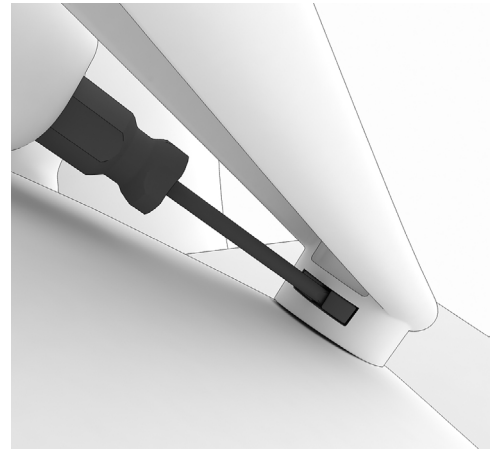

35. Insert a screw driver and rotate to expand the clip.

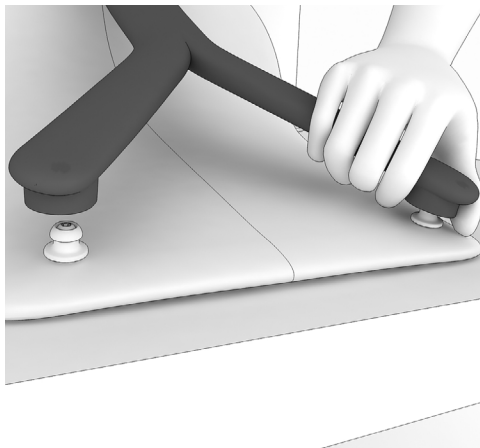

36. Pull spine off the back.

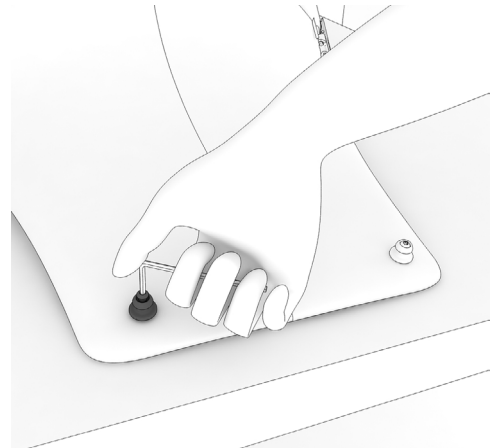

37. Use a T-20 torx wrench remove 1 screw from each pivot joint.

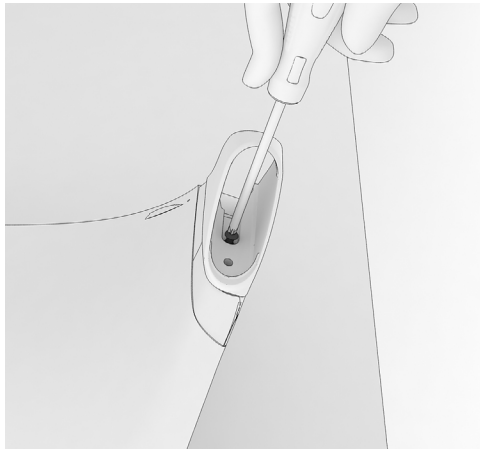

38. Using T-25 torx remove 1 screw from each sleeve.

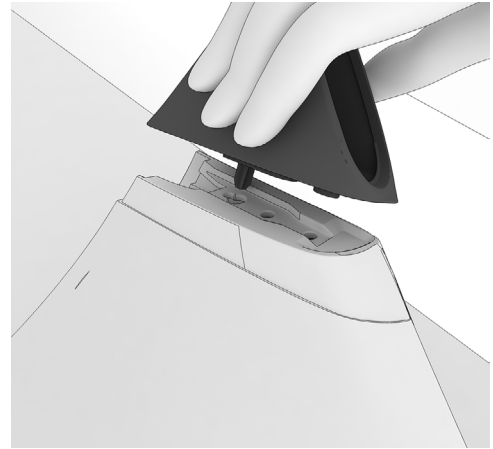

39. Pull sleeve off the back.

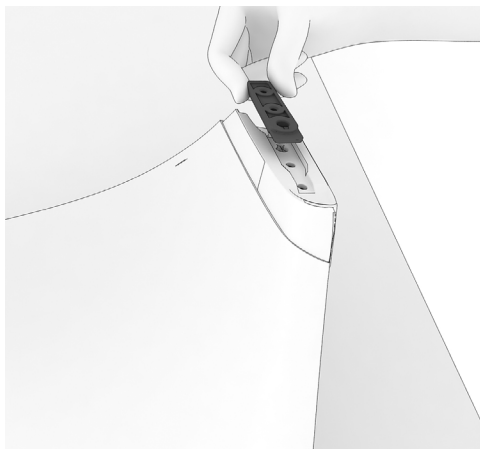

40. Slide out the plastic nut plate from slot towards bottom of the back.

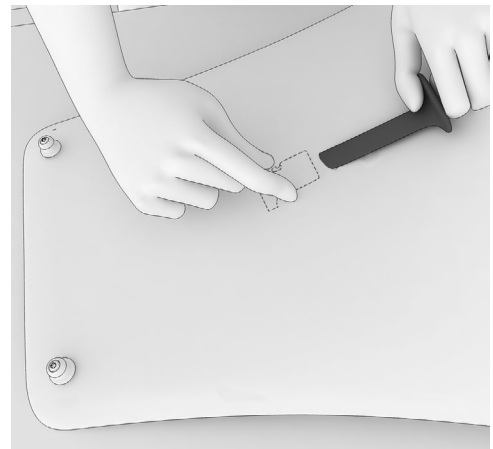

41. Using thumb & fore finger squeeze handle snaps together.

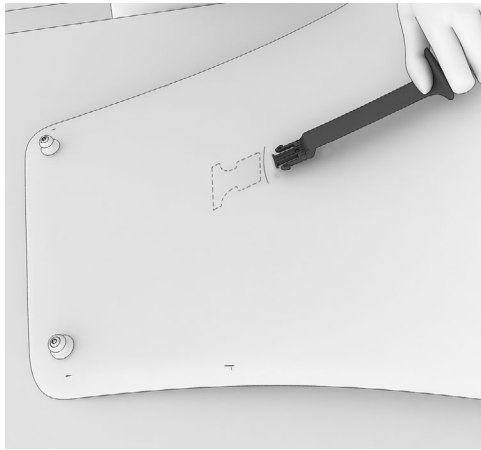

42. Remove lumbar handle.

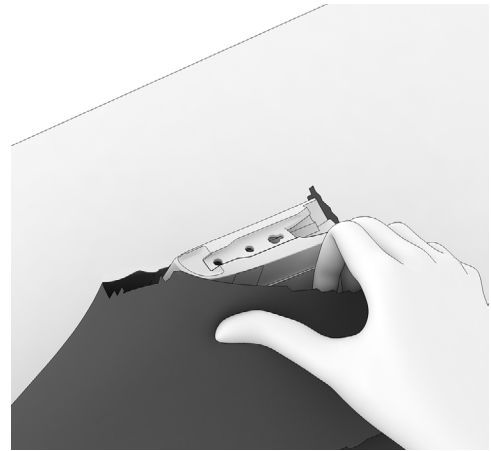

43. Pull the upholstery from back.

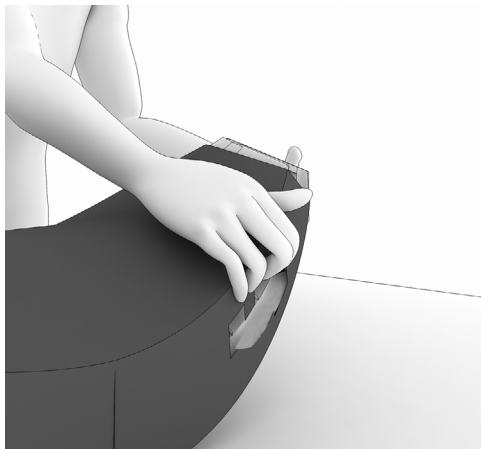

44. Pull the foam and remove from back.



45. Remove scrim material from foam.

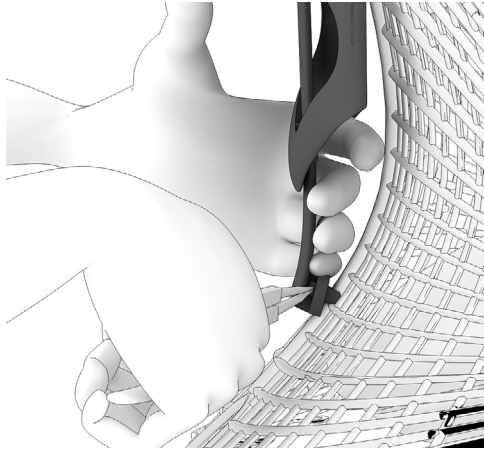

46. Using a nose plier remove hook on the bottom of the lumbar assembly.

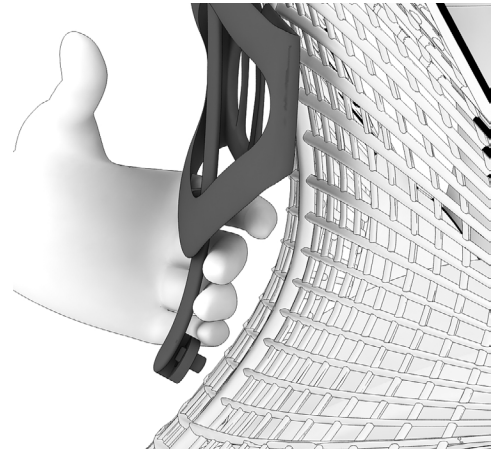

47. After disassembling one side, pull the bow back so that it does not engage again.

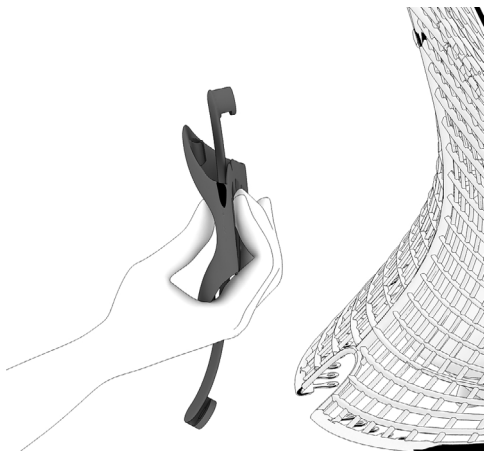

48. Remove lumbar from back insert.

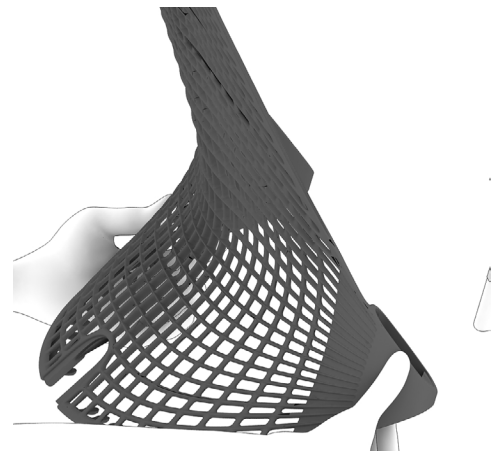

49. Remove suspension material.

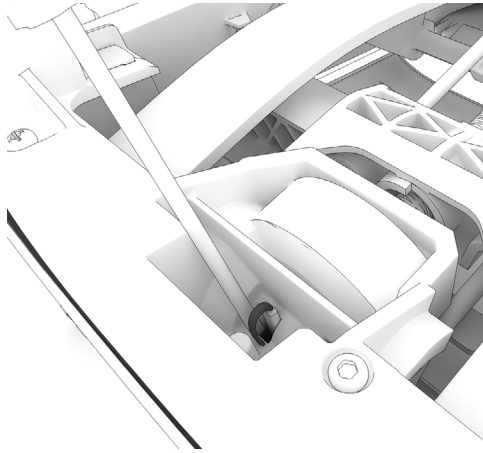

50. Pry the tab towards front of the tilt.

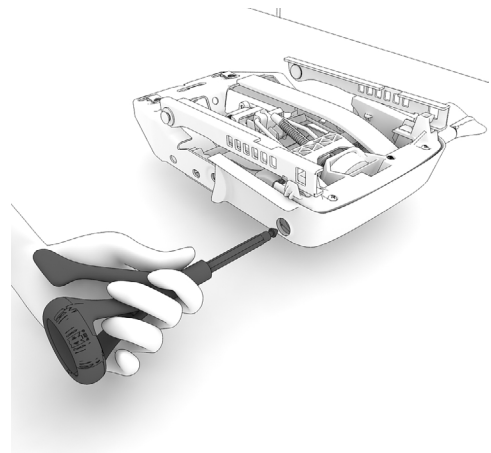

51. Pull out the handle assembly from tilt.

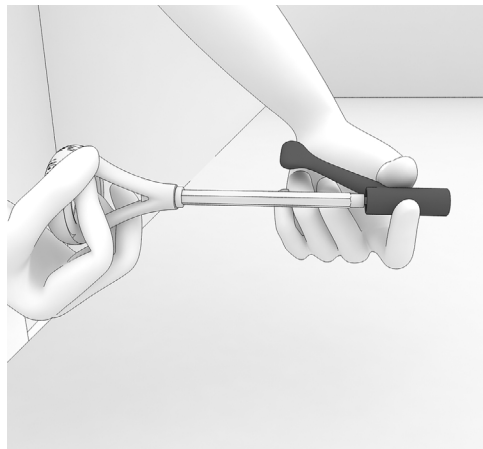

52. Slide off the lever from the assembly.

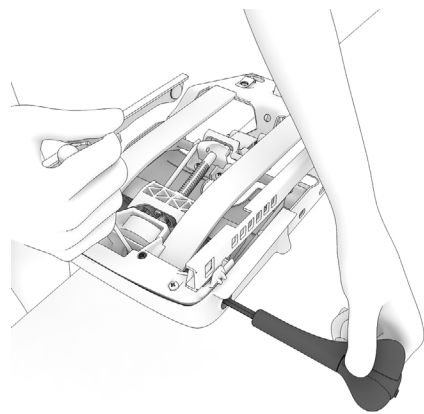

53. Pry the other side tab towards front of the tilt and pull out the lever.

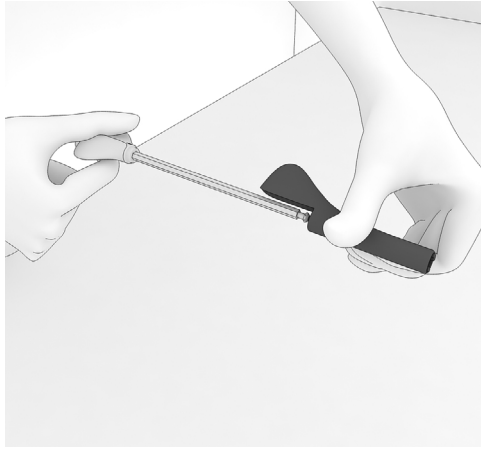

54. Slide off the other side lever from the assembly.

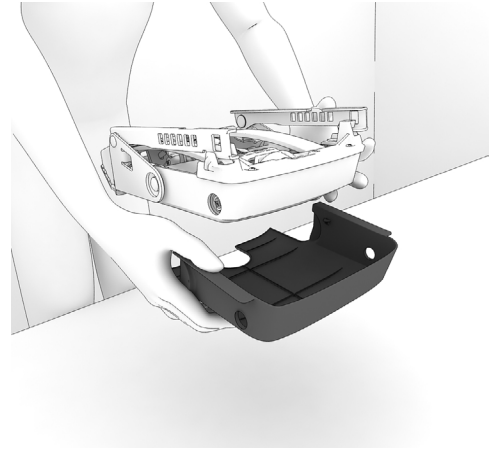

55. Pull off the tilt cover from tilt assembly.



Side Chair Disassembly



1. Using philip head screw driver remove screw from front underside of seat pan.

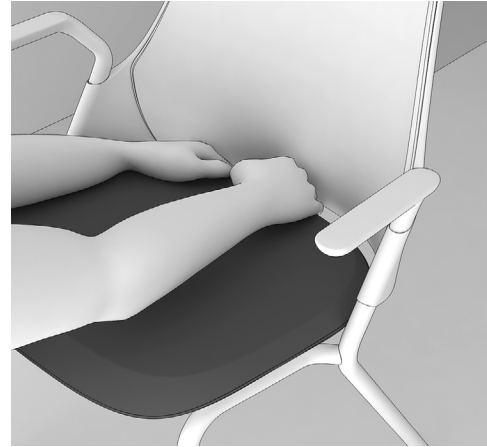

2. Pull up on rear of cushion to disengage snap and slide seat cushion forward.

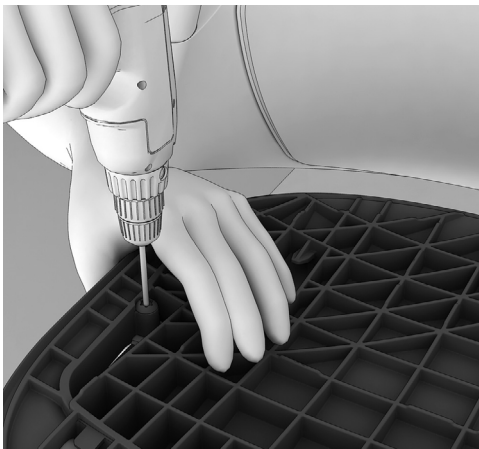

3. Using a power driver with a T-20 torx bit remove screws in seat pan.

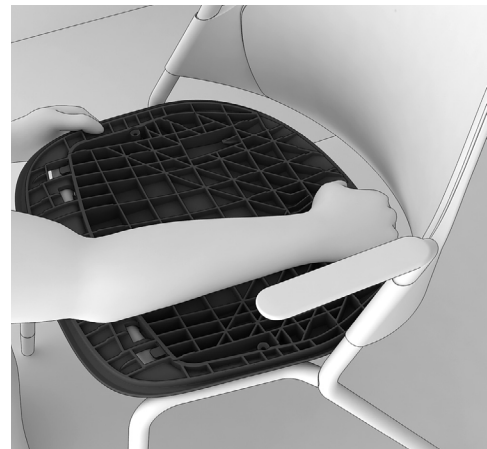

4. Slide seat pan rearward until all tabs are disengaged.

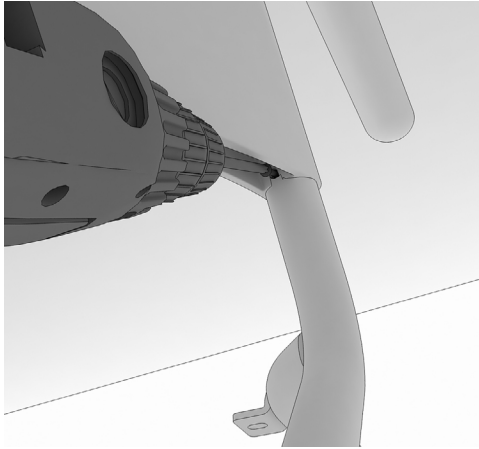

5. Using a power driver with a T-15 torx bit remove arm screws from back side.

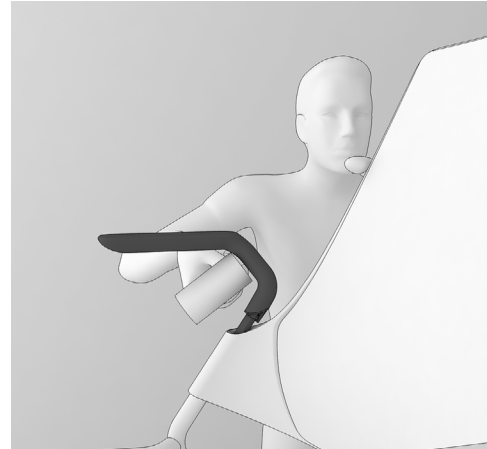

6. Using a rubber mallet tap on bottom of arm until arm comes out.

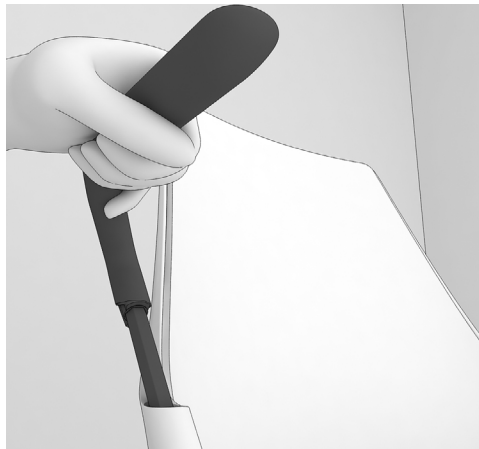

7. Pull off arms from both sides.

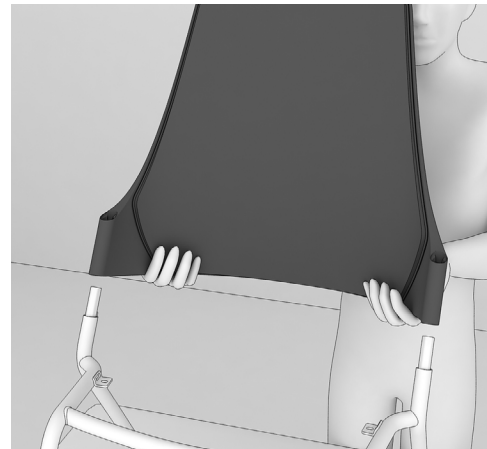

8. Pull or tap upward to remove back.

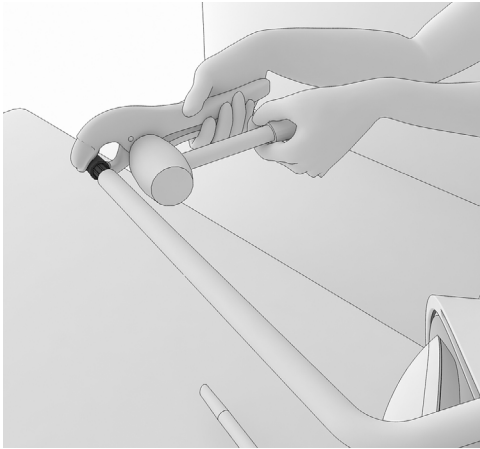

9. Clamp on to a glide using a vice grip and tap vice grip using a rubber mallet until glide comes out. Repeat the step on other legs to remove the remaining 3 glides.

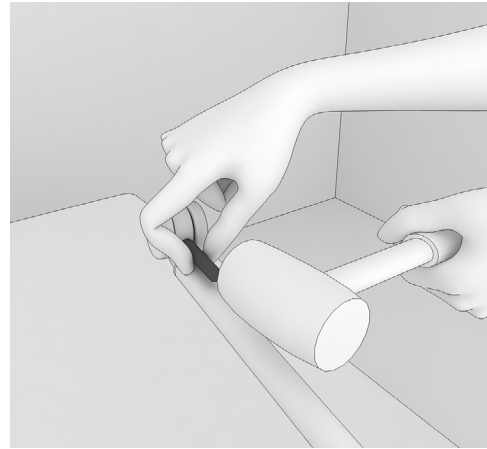

10. Place a rigid spacer between wheels on the body of caster and tap on it with a rubber mallet until caster wheel assembly comes off. Repeat the step on other legs to remove the remaining 3 casters.

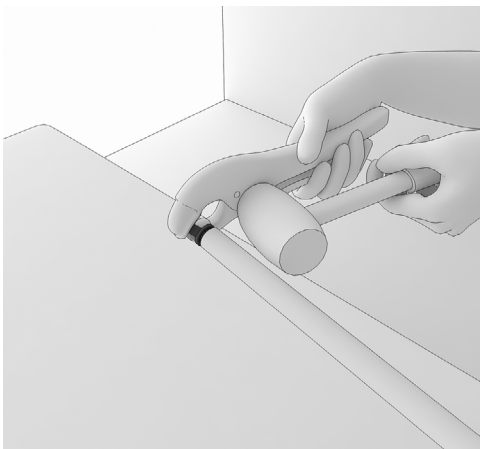

11. Clamp on to a caster receptacle using a vice grip and tap vice grip using a rubber mallet until receptacle comes out.

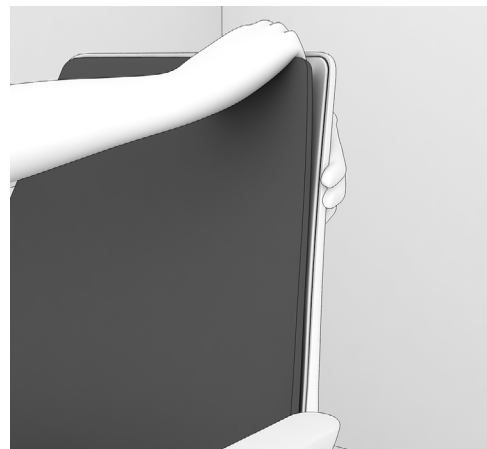

12. Carefully slide fingers between front fabric cover and frame, pull firmly. Pull corners first and then center.

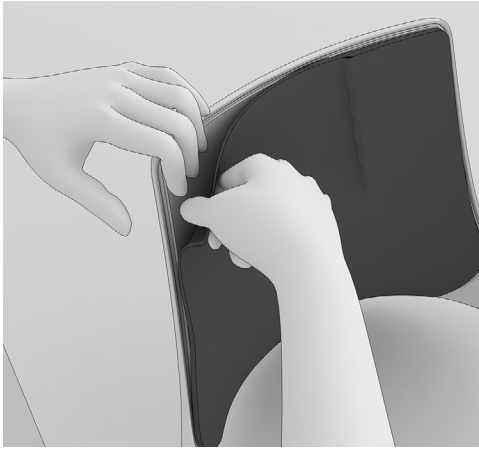

13. Remove the fabric from foam.



14. Remove fabric plastic back panel.

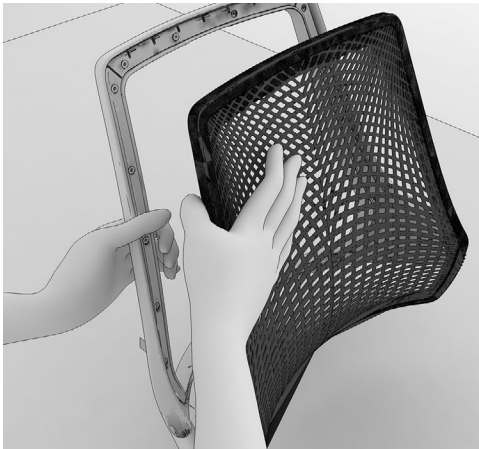

15. Pull the suspension material from back and remove.

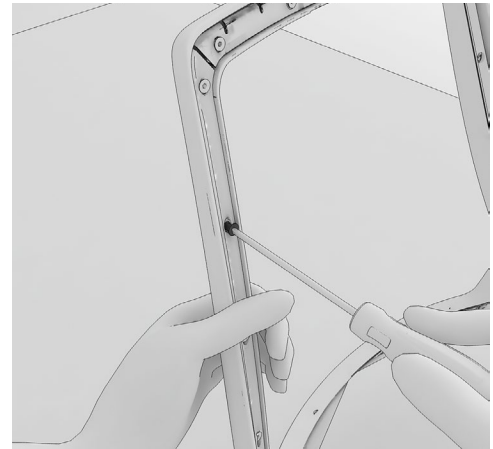

16. Using a phillip head screw driver remove all screws from retainer.

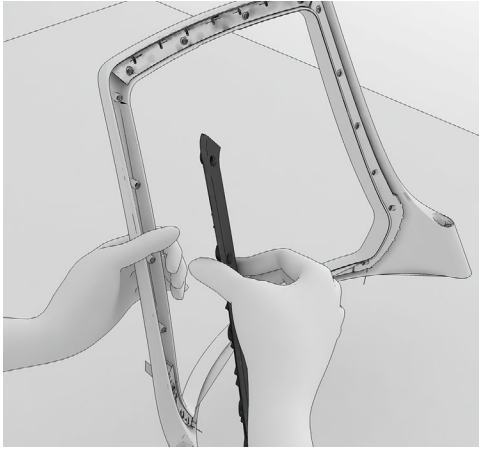

17. Remove the retainer from seat back.

18. Repeat step 16 to 17 remove rest of the pieces.



Work Stool Footring Disassembly

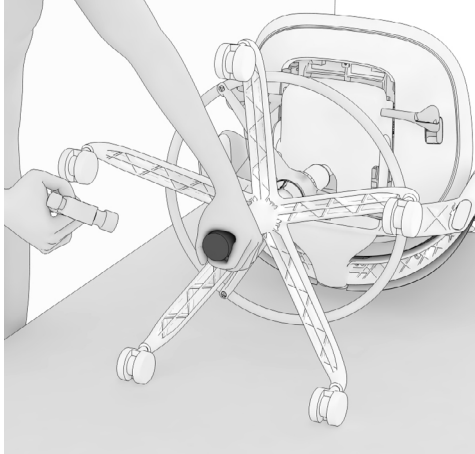

1. Place nylon cap over the end of cylinder and strike with hammer.

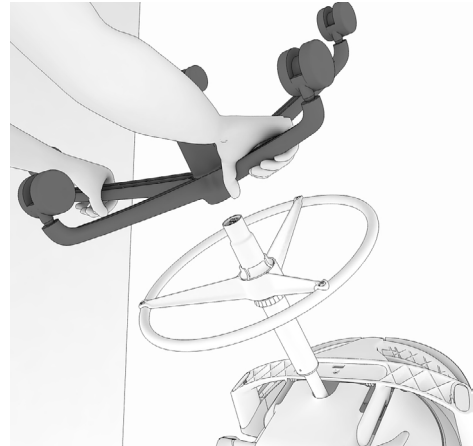

2. Disengage the base from cylinder.



3. Take out the footring from cylinder.